

What's in the Box

Denver Radio Face



(Vintage Overlay sold separately)

Shafts

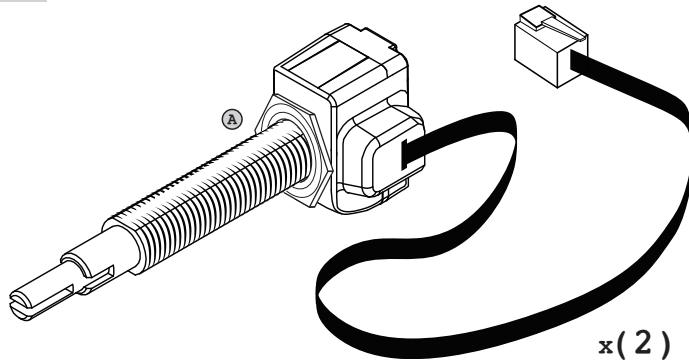

Hardware

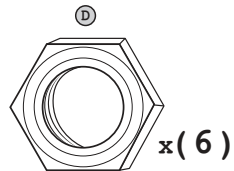
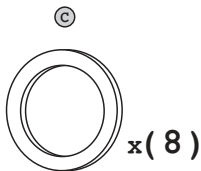
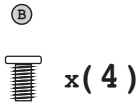

Installation

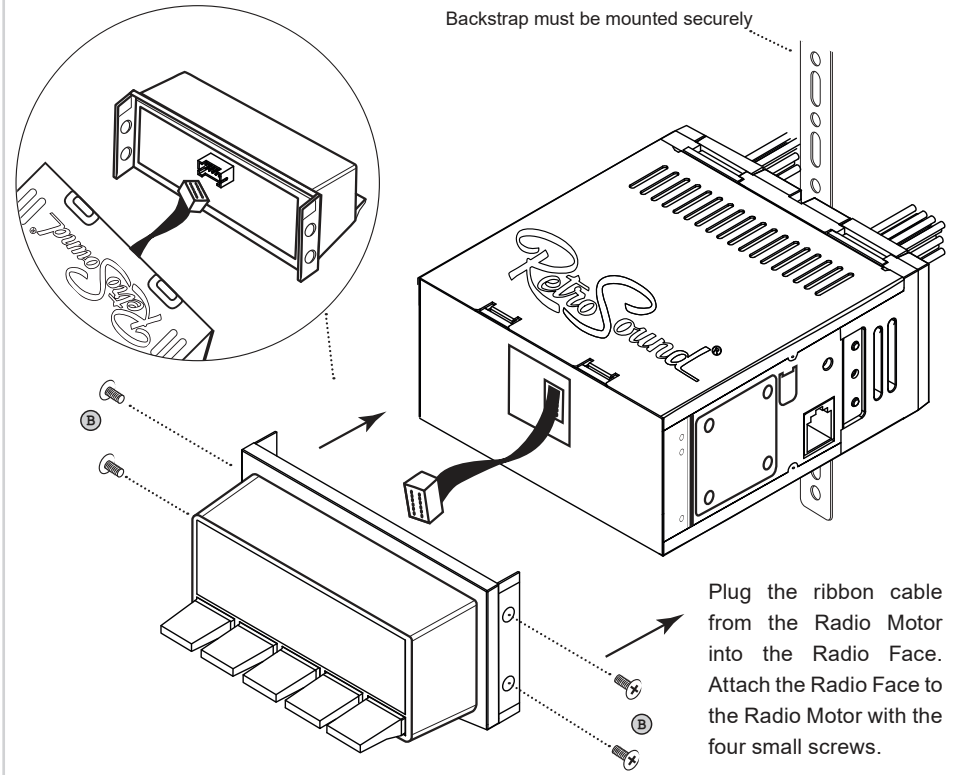

The 248 Gasket (packaged separately) may be needed for some installations. If needed, add the 248 gasket to the Radio Face before installing the radio into the dash.

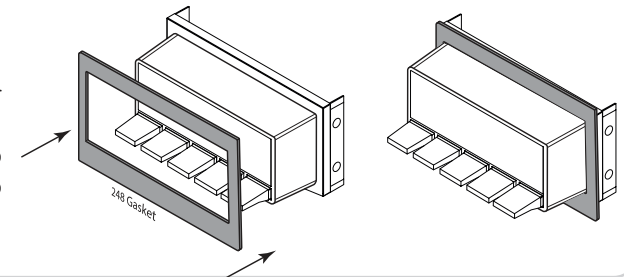

Refer to the user manual included in your motor box or on our website for more comprehensive instructions.

Control Layout

(Vintage Overlay sold separately)

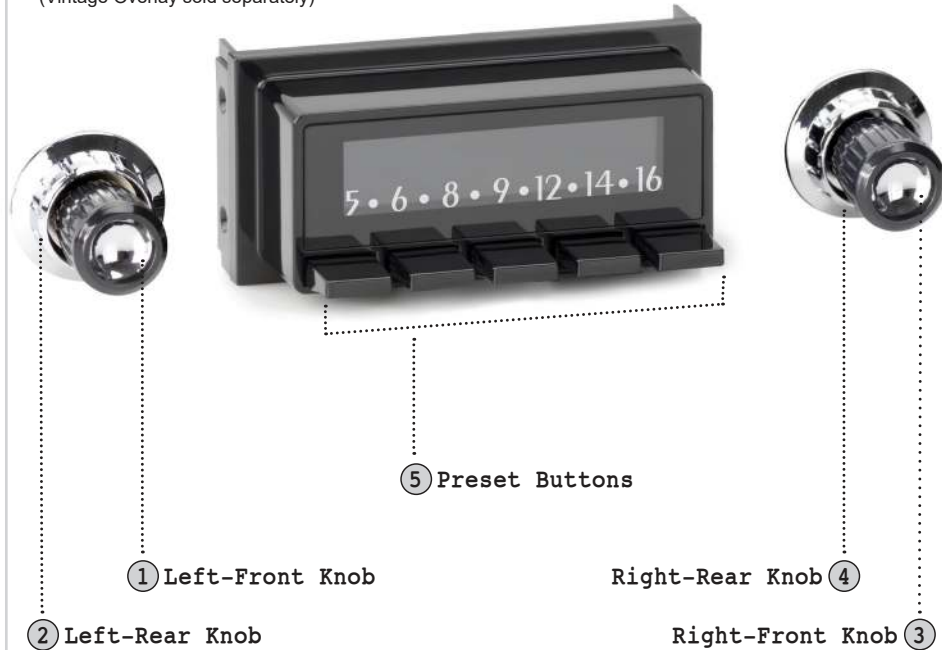

Radio Presets

Setting Radio Presets

To set a preset, tune to the station you want to set the preset to, and then press and hold the desired Preset Button(5) for two seconds.

Recalling Radio Presets

To recall a preset, simply press the Preset Button(5) your station was set to previously.

Basic Operation

Power On/Off

Press the Left-Front Knob(1) to power the unit on.
Press and hold the Left-Front Knob(1) to power the unit off.

Volume

Rotate the Left-Front Knob(1) to change the volume.

Changing Source Modes

Rotate the Left-Rear Knob(2) clockwise to cycle through the source modes.

Changing Radio Bands

Rotate the Right-Rear Knob(4) counter-clockwise to cycle through the radio bands.

Tune

Rotate the Right-Front Knob(3) to scroll through the stations.

Mute On/Off

Press the Right-Front Knob(3) to mute and unmute.

Equalizer (EQ)

Press the Left-Front Knob(1) to enter the Tone Control sub-menu. Press and release the Left-Front Knob(1) until you see the EQ setting you'd like to adjust. Rotate the Left-Front Knob(1) to adjust the setting. Press the Left-Front Knob(1) to move to the next item, and repeat to adjust each option. Let the unit time out to set.

Setting the Clock

Press and hold the Right-Front Knob(3) to enter the System Settings sub-menu. Rotate the Right-Front Knob(3) to cycle through the choices until you see CLK, then press the Right-Front Knob(3) to select. Rotate the Right-Front Knob(3) to adjust the hours. Then press the Right-Front Knob(3) again to move on to minutes. Rotate the Right-Front Knob(3) to adjust the minutes. Let the unit time out to set.

Display Color*

Press and hold the Right-Front Knob(3) to enter the System Settings sub-menu. Rotate the Right-Front Knob(3) to cycle through the choices until you see SCAN, then press the Right-Front Knob(3) to cycle through the colors. Let the unit time out to set.

Beep On/Off

Press and hold the Right-Front Knob(3) to enter the System Settings sub-menu. Rotate the Right-Front Knob(3) to cycle through the choices until you see BEEP ON/OFF, then press the Right-Front Knob(3) to choose between BEEP ON or BEEP OFF. Let the unit time out to set.

*Some features are not available on all radios.