

ROCKVILLE

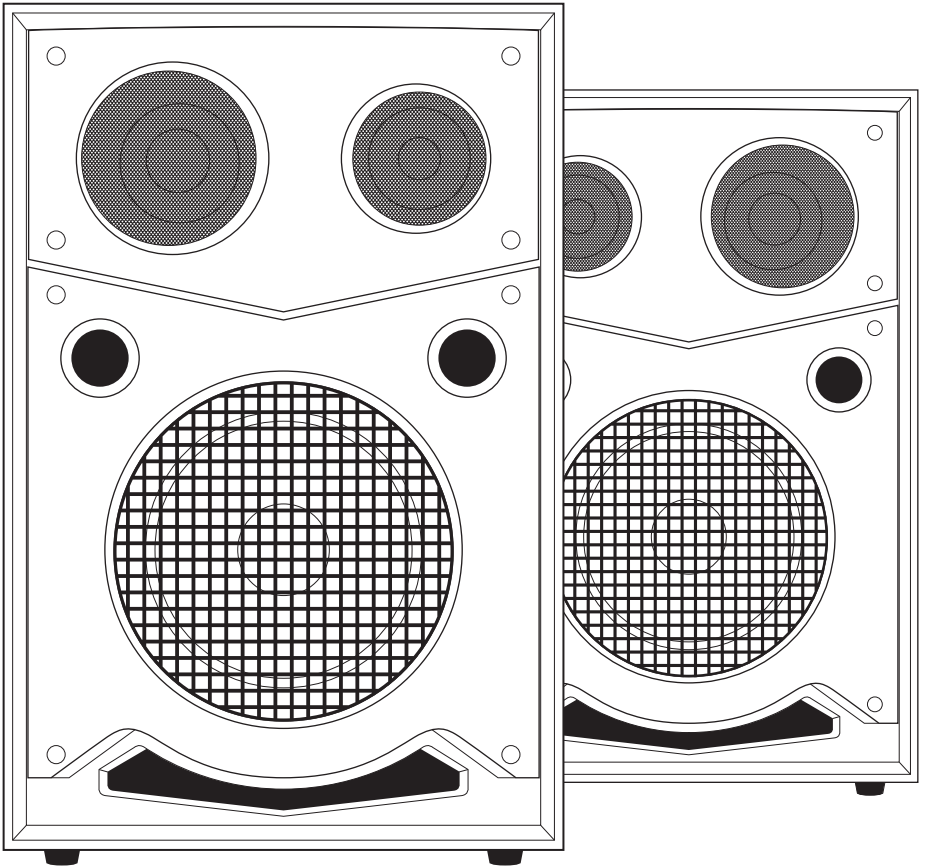

OWNER'S MANUAL

HOUSE PARTY SYSTEM 10

10" 1000W 3-WAY POWERED BLUETOOTH
HOME SPEAKERS w/LED

Who reads manuals?

Instead, go to vimeo.com/479870276 or scan the QR code and watch a short video, which shows you how to set this item up and how to use it.



ROCKWELL

Thank you for purchasing this Rockville House Party System 10 speaker system. Please read this owner's manual carefully for proper use of your Rockville House Party System 10. Should you need assistance, please call our technical help line at 1-646-758-0144, Monday through Friday, 9am to 5pm EST.

Included

- (2) Speakers
- 15 ft Cable to connect the active/passive speaker
- Remote control
- 6 ft Power cord
- FM antenna
- Owner's manual
- Warranty card

IMPORTANT SAFETY INSTRUCTIONS



- To reduce risk of electric shock, never open the unit. There are no user-serviceable parts; refer service to an authorized Rockville service center.
- Do not expose this unit to any kind of moisture.
- Please ensure that the unit is situated in a properly ventilated area.
- Make sure the unit is placed on a level and stable surface.

Functions

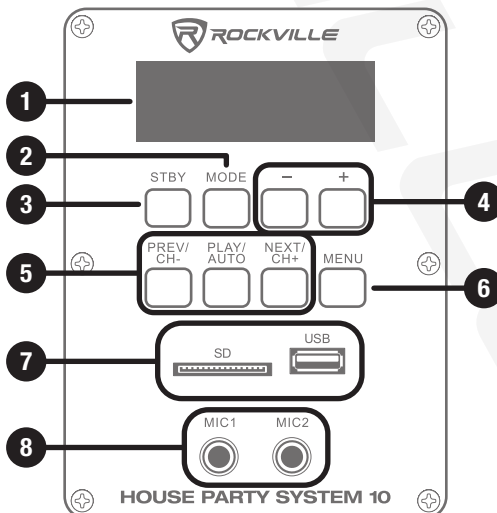

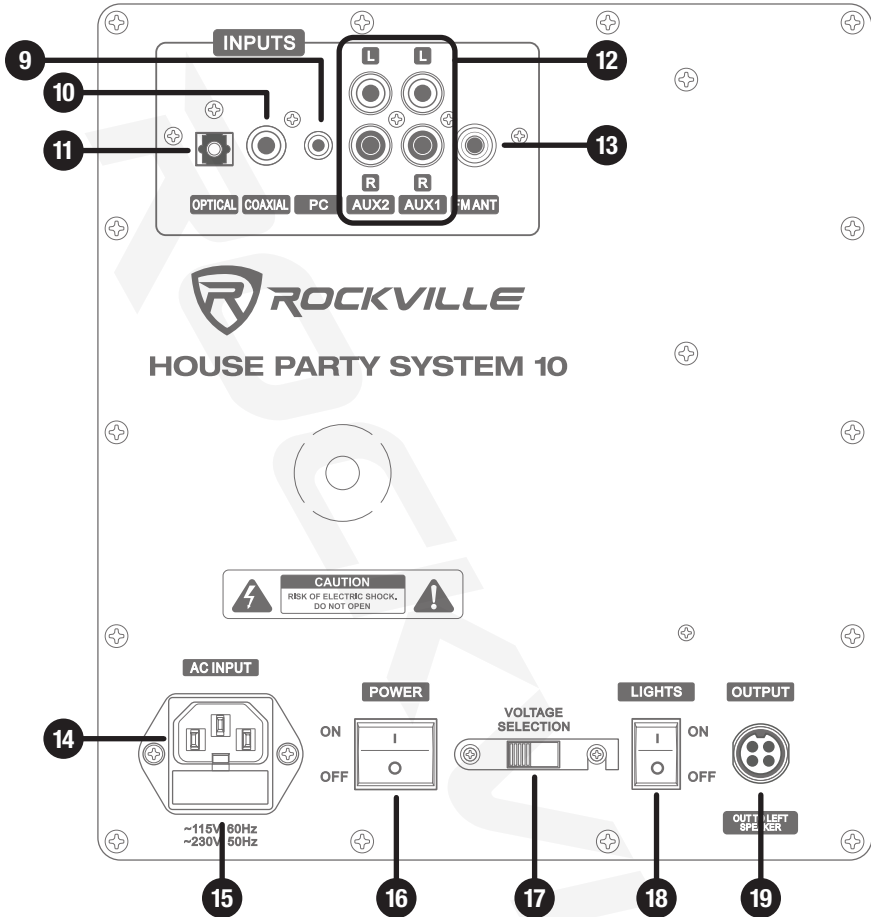

1. Display screen
2. Mode button: Press to switch between input modes: Bluetooth,USB/SD, FM, Coaxial, Optical, PC and AUX input.
3. Stand-by
4. Master volume controls
5. PLAY/AUTO: Press button once to play track, press again to pause. In FM radio mode press and hold to scan and save available stations.
PREV/CH- and NEXT/CH+: Press to select tracks in USB, SD, and BT mode or select stations in FM radio mode.
6. MENU: Press this button to enter adjustment screens for master volume, mic volume, echo volume, and bass/treble settings. Press the menu button repeatedly to cycle through the choices and use the -/+ buttons to make adjustments.
7. SD and USB inputs
8. 1/4" Unbalanced microphone inputs. Please note: We recommend using professional unbalanced dynamic mics as they are least likely to be affected by interference. Low cost, high impedance mics can be used; however, the level of background noise is higher since an unbalanced circuit is far more susceptible to interference.

Functions

- 9. 3.5mm PC input
- 10. Coaxial input
- 11. Optical input
- 12. L/R RCA AUX inputs
- 13. FM antenna jack
- 14. IEC power socket
- 15. Fuse compartment
- 16. Power button
- 17. Voltage selector switch
- 18. LED ON/OFF button
- 19. Output to left speaker

Remote Control

- 20. SD USB
- 21. Power
- 22. Select input source:
 - a. Bluetooth
 - b. FM radio
 - c. AUX1/AUX2/PC: Press repeatedly to cycle through the three input sources.
 - d. OPT/COAX: Press repeatedly to cycle through the two input sources.
- 23. Number pad: Directly select tracks in USB/SD modes and directly select stations in FM radio mode. To select tracks or stations with two digits, press the two numbers within 3 seconds. To select three-digit numbers, press "100+" and the other corresponding digits within 3 seconds.
- 24. REPEAT: Press to repeat the current track in USB/SD mode.
- 25. CH+/-: Press these buttons to select preset stations in FM radio mode.
- 26. TREBLE +/-
- 27. Playback controls: ◀◀ - press to select previous track, ▶▶ - press to start or pause playback, ▶▶▶ - press to select next track.
- 28. BASS +/-
- 29. SAVE: Press to save stations in FM radio mode.
- 30. AUTO: Press to search and automatically store stations in FM radio mode.
- 31. RESET: used to reset unit to factory settings
- 32. TUNE +/-: used to manually tune stations in FM radio mode
- 33. EQ +/-: Press to toggle between preset EQ curves.
- 34. MIC +/-: Press to adjust microphone input volume.
- 35. ECHO +/-: Press to adjust echo effect volume.
- 36. DISP +/-: Press to adjust display brightness.
- 37. VOL +/-: Press to adjust volume level.
- 38. MUTE

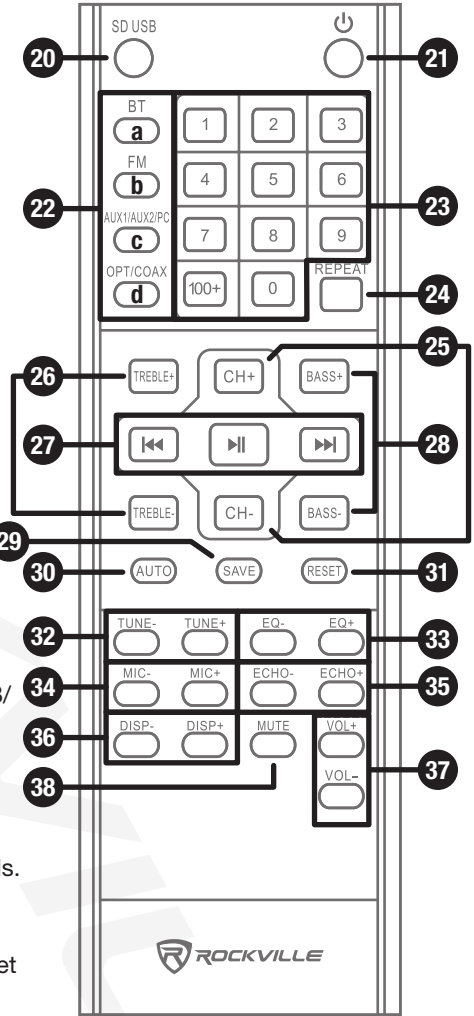

Operation

Bluetooth

To connect your iPod, iPad, iPhone, MP3 player, Android phone or tablet, or any other Bluetooth-capable device, follow the steps listed below.

1. Make sure the speaker is ON.
2. Press the MODE button on the unit or the BT button on the remote control until you hear a two-tone sound indicating that Bluetooth mode is enabled.
3. Turn on the Bluetooth feature on your device and ensure that it is discoverable. Look for and select "HOUSE PARTY SYSTEM 10" from the list of available devices.
4. Use the PLAY/AUTO button on the unit or the ►|| button on the remote control to pause and resume playback.
5. Use the PREV/CH- and NEXT/CH+ buttons on the unit or the ◀◀/▶▶ on the remote control for track selection.
6. Use the master volume +/- buttons on the unit or the VOL +/- buttons on the remote control to set the volume level.

Please note: Use devices equipped with Bluetooth 5.0 to achieve maximum range. The unit will remember the last paired device.

USB/SD

The built-in media player allows you to play MP3 files. To access this function, follow the steps below.

1. Make sure the speaker is ON.
2. Insert a USB flash drive or SD card into the corresponding port. Music should begin playing automatically.
3. Use the PLAY/AUTO button on the unit or the ►|| button on the remote control to pause and resume playback.
4. Use the PREV/CH- and NEXT/CH+ buttons on the unit or the ◀◀/▶▶ on the remote control for track selection.
5. Use the master volume +/- buttons on the unit or the VOL +/- buttons on the remote control to set the volume level.

Please note: The unit can accept SD cards and USB drives with a max capacity of 32GB. Accepted formats are MP3, WMA, and WAV. Operation may be slower when searching large files or a USB drive or SD card that is filled to capacity.

FM Radio

To use the FM radio function, follow the steps below.

1. Connect and fully extend the included antenna.
2. Press the MODE button on the unit or the FM button on the remote control to place the unit in FM radio mode.
3. Press the PLAY/AUTO button on the unit or the AUTO button on the remote control to initiate the auto-scan function. The speaker will automatically scan for and save all available stations.
4. Use the PREV/CH- and NEXT/CH+ buttons on the unit or CH-/CH+ keys on the remote control to toggle through the saved stations.
5. To manually tune a specific station, use the number keys on the remote control. To save a manually tuned station, press the SAVE button on the remote. Then use the CH+/- keys to select the slot to which it will be saved and press the SAVE button. If the operation is successful, you will see the word "GOOD" on the display.

Features and Specifications

- 250W RMS power/1000W peak power
- Built-in 2-channel stereo biampifier (individual amps for the woofers, mids, and tweeters)
- 3-way speaker design has a 10" woofer, 5" mid-range, and 3" tweeter
- Professional crossovers for top sound quality
- Built-in Bluetooth chipset with 70ft range
- USB and SD card playback (supports 32GB)
- Built-in FM radio with antenna
- Two 10" subwoofers with incredibly loud and deep bass response
- Two 5" mid-range speakers give you incredible mids and vocal sounds
- Two 3" tweeters for incredible highs
- Special RGB LEDs for woofers and mid-range with on/off switch
- Built-in preset equalizer curves
- Adjustable bass and treble
- 0.59" thick top quality MDF cabinet
- Two stereo RCA inputs
- 3.5mm aux inputs
- Two ¼" mic inputs for karaoke with volume, echo, and mic volume controls
- One optical input
- One coaxial input
- Front panel digital display
- Class A/B high-power design with 4x Toshiba C5198 chips
- Power supply: AC 115/230V
- Frequency response: 40Hz – 20kHz
- S/N Ratio: ≥60dB
- Max SPL: 115dB
- Speaker dimensions (W x H x D): 15" x 23.6" x 11.8"
- Speaker net weight (combined): 66lbs.

Troubleshooting

PROBLEM	SOLUTION
No power	<ol style="list-style-type: none">1. Make sure the unit is plugged in and the power switch is in the ON position.2. Check that the power cable is plugged in tightly to the unit.
No sound/ distorted sound	<ol style="list-style-type: none">1. Check that all input cables are plugged in correctly.2. Check all volume settings (on the unit and the remote control).3. Be sure volume of the input source is set properly.4. If using mics, make sure the corresponding volume control is set properly.5. Be sure your microphones are turned on.6. If volume and EQ settings are maxed out, turn one of them down as you may be overdriving the unit.
Buzzing sound	Make sure you are using a proper cable. For 1/4" cables, there are three types: instrument, TS (unbalanced), and TRS (balanced). Check the requirements of the connected gear and the input of the speaker, and make sure you are using the appropriate cable.
Mic feedback	Point the mics away from the speaker. Make sure they are behind the speaker.
Poor mic sound	Make sure the microphones are on, that you are using the appropriate cable, and that the volume settings are turned up.
Bluetooth pairing fails	<ol style="list-style-type: none">1. Check to see that both devices are turned on and that your Bluetooth device is discoverable.2. Turn both devices off and then on.3. Make sure you've selected the proper source.4. Make sure that the Bluetooth device is within 5 feet of the unit.5. Move both devices away from other Bluetooth devices, microwaves, wireless routers, and other electronics.6. Make sure that the unit is not paired to a previously paired device or to another speaker. <p>Please refer to pages 6 for Bluetooth pairing procedures.</p>
No SD or USB playback	<ol style="list-style-type: none">1. Make sure you've selected the proper source.2. Make sure that the audio files are in the specified format.3. Make sure the drive is not larger than the acceptable capacity (see page 6 for details).

Fuse Replacement Diagram

① Use a screwdriver to release the fuse holder.

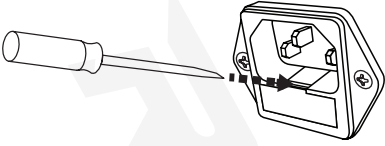

② Remove the fuse holder.

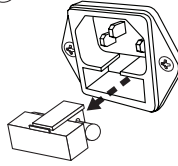

③ Remove the fuse.

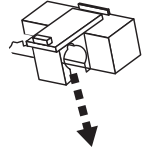

④ Replace the fuse.

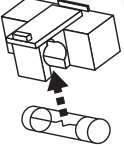

⑤ Reinsert the fuse holder.

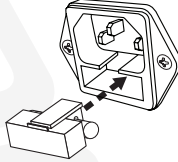

FEDERAL COMMUNICATIONS COMMISSION COMPLIANCE INFORMATION

Responsible party name: Rockville

Address: 600 Bayview Ave
Entrance A
Inwood, NY 11096

Hereby declares that the product House Party System 10 complies with FCC rules as mentioned in the following paragraph:

This device complies with Part 15 of the FCC rules. Operation is subject to the following two conditions: (1) this device may not cause harmful interference, and (2) this device must accept any interference received, including interference that may cause undesired operation.

Note: This equipment has been tested and found to comply with the limits for a Class B digital device, pursuant to Part 15 of the FCC rules. These limits are designed to provide reasonable protection against harmful interference in a residential installation. This equipment generates, uses and can radiate radio frequency energy and, if not installed and used in accordance with the instructions, may cause harmful interference to radio communications. However, there is no guarantee that interference will not occur in a particular installation. If this equipment does cause harmful interference to radio or television reception, which can be determined by turning the equipment off and on, the user is encouraged to try to correct the interference by one or more of the following measures:

- Reorient or relocate the receiving antenna.
- Increase the separation between the equipment and receiver.
- Connect the equipment to an outlet on a circuit different from that to which the receiver is connected.
- Consult the dealer or an experienced radio/TV technician for help.

ROCKWELL

ROCKVILLE

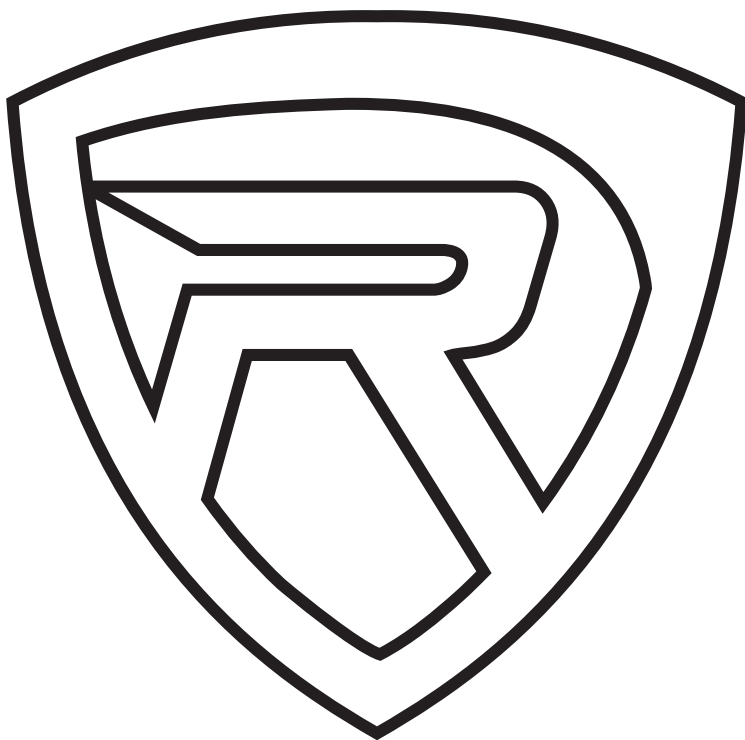

RockvilleAudio.com

© 2020 ROCKVILLE // Features and specifications are subject to change and/or improvement without notice.