

SARGENT®

ASSA ABLOY

10X Line Cylindrical Lever Lock Parts Manual



For assistance, contact SARGENT at
800-727-5477 or www.sargentlock.com

Copyright © 2021, 2022, Sargent Manufacturing Company, an ASSA ABLOY Group company. All rights reserved.
Reproduction in whole or in part without the express written permission of Sargent Manufacturing Company is prohibited.

A8287-D 01/23

Experience a safer
and more open world



Table of Contents

10X Line Cylindrical Lever Locks

SARGENT[®]

ASSA ABLOY

Exploded View.....	3
Lockbodies & Mounting Plate.....	4
Spring Housing Assemblies.....	5
Roses & Misc.....	6
Latches.....	7
Strikes.....	8
Cylinders.....	9-11
Standard Levers and Components.....	12
How to Order Parts.....	13
Finishes.....	13

Exploded View

10X Line Cylindrical Lever Locks

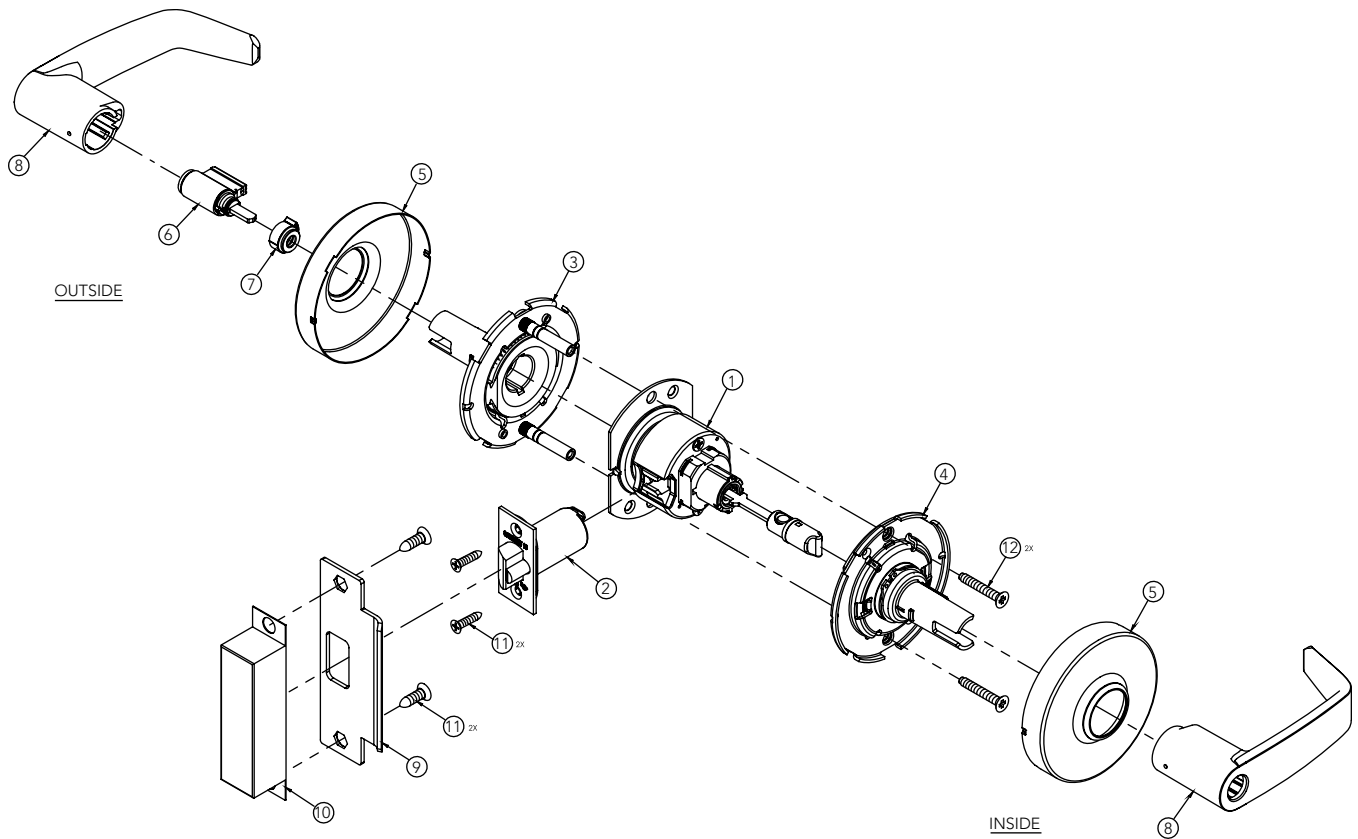

Item	Description	Page #
1	Lockbody with Mounting Plate	4
2	Latch	7
3	Spring Housing Assembly, Outside	5
4	Spring Housing Assembly, Inside	5
5	Rose	6
6	Cylinder	9
7	Cylinder Spacer	11
8	Lever	12
9	Strike	8
10	Strike Box	8
11	Latch & Strike Screws	6
12	Throughbolt Screws	6

Experience a safer
and more open world

The warranty on SARGENT® products becomes void if the product is modified in any way, regardless of whether the modification causes or contributes to any alleged defect. If a SARGENT product is modified it may no longer meet industry certification and quality control standards applicable to the original product and is no longer a genuine SARGENT product.

Copyright © 2021, 2023 Sargent Manufacturing Company, an ASSA ABLOY Group company. All rights reserved. Reproduction in whole or in part without the express written permission of Sargent Manufacturing Company is prohibited.

Lockbodies

10X Line Cylindrical Lever Locks

SARGENT

ASSA ABLOY

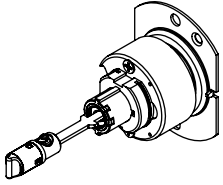

Mechanical Lockbody
1-3/8" - 2" Door

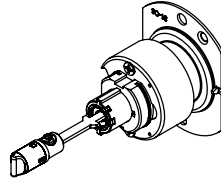

Mechanical Lockbody
2-1/4" Door

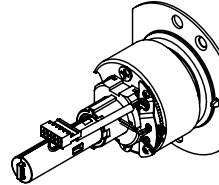

Electrified Lockbody
1-3/8" - 2" Door

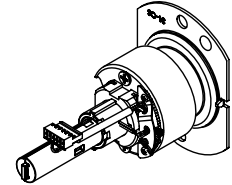

Electrified Lockbody
2-1/4" Door

Mechanical Lockbody (Includes Mounting Plate)

Description	Function	Part Number 1-3/8" - 2" Door		Part Number 2-1/4" Door	
		Std/Rigid Lever	Freewheeling	Std/Rigid Lever	Freewheeling
Storeroom or Closet	10XG04	10-3586	10-3587	10-3668	10-3669
Entrance or Office	10XG05	10-3588*	10-3589*	10-3670*	10-3671*
Communicating Storeroom	10XG07	10-3590	10-3591	10-3672	10-3673
Communicating Classroom	10XG08	10-3592	10-3593	10-3674	10-3675
Exit	10XG13	10-3586	10-3587	10-3668	10-3669
Patio or Privacy	10XG14	10-3618*	10-3619*	10-3702*	10-3703*
Passage	10XU15	10-3596	N/A	10-3678	N/A
Exit or Communicating	10XG15-3	10-3597	N/A	10-3679	N/A
Classroom Security, Apartment, Exit, Privacy	10XG16	10-3598	10-3599	10-3680	10-3681
Utility, Asylum or Institutional	10XG17	10-3600	10-3601	10-3682	10-3683
Entrance or Office	10XG24	10-3594*	10-3595*	10-3676*	10-3677*
Store or Storeroom	10XG26	10-3602	10-3603	10-3684	10-3685
Communicating	10XG30	10-3604	10-3605	10-3686	10-3687
Classroom	10XG37	10-3710	10-3711	10-3712	10-3713
Classroom Security Intruder	10XG38	10-3606	10-3607	10-3688	10-3689
Service Station	10XG44	10-3608*	10-3609*	10-3690*	10-3691*
Hotel, Dormitory or Apartment	10XG50	10-3610*	10-3611*	10-3692*	10-3693*
Corridor/Dormitory (modified)	10XG53	10-3612*	10-3613*	10-3694*	10-3695*
Corridor/Dormitory	10XG54	10-3614*	10-3615*	10-3696*	10-3697*
Barrier Free Storeroom/Public Restroom	10XG60	10-3620	10-3621	10-3698	10-3699
Time Out Lock	10XG64	10-3616*	10-3617*	10-3700*	10-3701*
Privacy/Bathroom	10XU65	10-3618*	10-3619*	10-3702*	10-3703*
Hospital Privacy	10XU68	10-3618*	10-3619*	10-3702*	10-3703*
Storeroom or Closet with Request to Exit	RX-10XG04	10-2934	10-2935	10-2942	10-2943
Entrance or Office with Request to Exit	RX-10XG05	10-2936*	10-2937*	10-2944*	10-2945*
Passage with Request to Exit	RX-10XU15	10-2938	10-2939	10-2946	10-2947
Classroom with Request to Exit	RX-10XG37	10-2940	10-2941	10-2948	10-2949

*Includes finished button. Specify Finish.

Electrified Lockbody (Includes Mounting Plate) and Lock Harness

Description	Function	Part Number 1-3/8" - 2" Door		Part Number 2-1/4" Door	
		Std/Rigid Lever	Freewheeling	Std/Rigid Lever	Freewheeling
Electromechanical	10XG70 10XG71	10-3722	10-3763	10-3795	10-3797
Electromechanical with Request to Exit	RX-10XG70 RX-10XG71	10-3723	10-3764	10-3796	10-3798

A8287.D 01/23

The warranty on SARGENT® products becomes void if the product is modified in any way, regardless of whether the modification causes or contributes to any alleged defect. If a SARGENT product is modified it may no longer meet industry certification and quality control standards applicable to the original product and is no longer a genuine SARGENT product.

Copyright © 2021, 2023 Sargent Manufacturing Company, an ASSA ABLOY Group company. All rights reserved. Reproduction in whole or in part without the express written permission of Sargent Manufacturing Company is prohibited.

Spring Housing Assemblies

10X Line Cylindrical Lever Locks

SARGENT

ASSA ABLOY

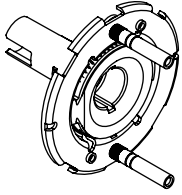

Part No. 10-3571
Spring Housing Assembly, Outside

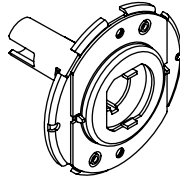

Part No. 10-3572
Spring Housing Assembly, Inside

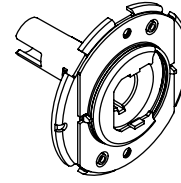

Part No. 10-3762
Spring Housing Assembly, Inside

Outside Spring Housing Assemblies (1-3/8" to 2-1/4" Door)

Part Number	Description
10-3571	All Functions except 07, 08, 15-3, 93, 94
10-3579	All Functions for Keso Cylinders
10-3584	All Functions for Yale® LFIC

Inside Spring Housing Assemblies (1-3/8" to 2" Door)

Part Number	Description
10-3572	Functions 04, 05, 13, 14,15, 15-3, 24, 37, 44, 50, 53, 54, 60, 64, 65, 68
10-3622	Functions 16, 17, 26, 30, 38
10-3580	Functions 16, 17, 26, 30, 38 for Keso Cylinders
10-3585	Functions 16, 17, 26, 30, 38 for Yale® LFIC
10-3762	Functions 70, 71, RX-04, RX-05, RX-15, RX-37

Inside Spring Housing Assemblies (2-1/4" Door)

Part Number	Description
10-3704	Functions 04, 05, 13, 14,15, 15-3, 24, 37, 44, 50, 53, 54, 60, 64, 65, 68
10-3705	Functions 16, 17, 26, 30, 38
10-3706	Functions 16, 17, 26, 30, 38 for Keso Cylinders
10-3707	Functions 16, 17, 26, 30, 38 for Yale® LFIC
10-2423	Functions 70, 71, RX-04, RX-05, RX-15, RX-37

Dummy Spring Housing Assemblies

Part Number	Description
10-3573	Outside 93, 94, 94-2
10-3574	Inside 94, 94-2

Experience a safer
and more open world

The warranty on SARGENT® products becomes void if the product is modified in any way, regardless of whether the modification causes or contributes to any alleged defect. If a SARGENT product is modified it may no longer meet industry certification and quality control standards applicable to the original product and is no longer a genuine SARGENT product.

Copyright © 2021, 2023 Sargent Manufacturing Company, an ASSA ABLOY Group company. All rights reserved. Reproduction in whole or in part without the express written permission of Sargent Manufacturing Company is prohibited.

Roses & Misc.

10X Line Cylindrical Lever Locks

SARGENT®

ASSA ABLOY

Roses

Part Number	Description	Function
10-1202*	G Rose/Scalp	All
10-1203*	G Rose/Scalp	Inside 38
10-1200*	L Rose/Scalp	All
10-1201*	L Rose/Scalp	Inside 38
10-1260*	Blank Rose/Plate	07, 08, 15-3

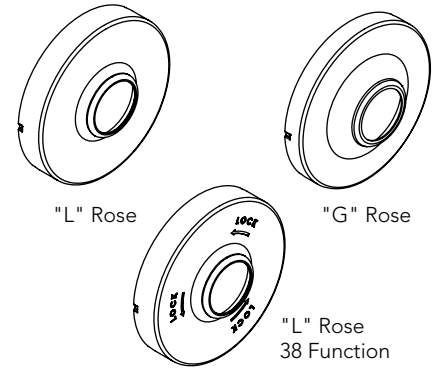

Mounting Plates

Part Number	Description
10-1071	Outside Support/Mounting Plate 1-3/8" - 2" Door
10-1276	Outside Support/Mounting Plate 2-1/4" Door
10-3656	Outside Mounting Plate Assembly Functions 15-3, 07, 08

Screw Packs - Complete

Part No.	Description
10-1224*	Standard (with 808 ANSI 4-7/8" strike screws)
10-1225*	93 Function
10-1250*	29- Option (with 800 T-strike screws)
10-1226*	36- Option, 6-Lobe Security Head Torx® (with ANSI & T-strike screws)
10-1227*	37- Option, Spanner Head (with ANSI & T-strike screws)
10-3761*	BHW Trim, 6-Lobe Security Head Torx® (with mounting, latch and strike screws)



Miscellaneous

Part No.	Description
10-3188	1-3/8" Door Adapter Plate Pack (1- option)
10-3667*	Dummy/Blank Front Pack (94-2)
10-0043	Push Pin Tool
14-0057	Emergency Release Key - Privacy/Bathroom Function (65)

* Specify Finish

Latches

10X Line Cylindrical Lever Locks



Plain/Unguarded Latch - 10XU15, 10XU65, 10XU68:

Part No.	Front	Front Width	Backset	Throw
10-3187	Square Corner	1" (25mm)	2-3/8" (60mm)	1/2" (13mm)
10-2022	Square Corner	1-1/8" (29mm)	2-3/4" (70mm)	1/2" (13mm)
10-2054	Square Corner	1-1/8" (29mm)	3-3/4" (95mm)	1/2" (13mm)
10-2057	Square Corner	1-1/8" (29mm)	5" (127mm)	1/2" (13mm)

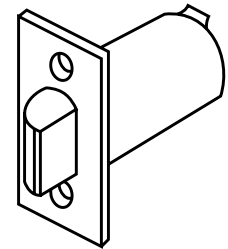

Plain/Unguarded

Deadlocking/Guarded Latch - All Other Mechanical Functions:

Part No.	Front	Front Width	Backset	Throw
10-3186	Square Corner	1" (25mm)	2-3/8" (60mm)	1/2" (13mm)
10-3192	Square Corner	1-1/8" (29mm)	2-3/4" (70mm)	1/2" (13mm)
10-2053	Square Corner	1-1/8" (29mm)	3-3/4" (95mm)	1/2" (13mm)
10-2058	Square Corner	1-1/8" (29mm)	5" (127mm)	1/2" (13mm)
10-2634*	Square Corner	1-1/8" (29mm)	2-3/4" (70mm)	3/4" (19mm)

* 04/26D finish only

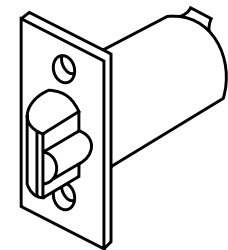

Deadlocking/Guarded

Deadlocking/Guarded Latch - Electrified Functions:

Part No.	Front	Front Width	Backset	Throw
10-3433	Square Corner	1" (25mm)	2-3/8" (60mm)	1/2" (13mm)
10-3430	Square Corner	1-1/8" (29mm)	2-3/4" (70mm)	1/2" (13mm)
10-3431	Square Corner	1-1/8" (29mm)	3-3/4" (95mm)	1/2" (13mm)
10-3432	Square Corner	1-1/8" (29mm)	5" (127mm)	1/2" (13mm)

Miscellaneous:

Part No.	Description
10-2059	3-3/4" (95mm) Latch extension with sleeve
10-2060	5" (127mm) Latch extension with sleeve
10-0048	Latch extension sleeve

When ordering latches separately, specify Part No. x Finish (e.g., 10-3186 x 32D). Screw pack must be ordered separately, see page 6.

Experience a safer
and more open world

The warranty on SARGENT® products becomes void if the product is modified in any way, regardless of whether the modification causes or contributes to any alleged defect. If a SARGENT product is modified it may no longer meet industry certification and quality control standards applicable to the original product and is no longer a genuine SARGENT product.

Copyright © 2021, 2023 Sargent Manufacturing Company, an ASSA ABLOY Group company. All rights reserved. Reproduction in whole or in part without the express written permission of Sargent Manufacturing Company is prohibited.

Strikes

10X Line Cylindrical Lever Locks

SARGENT

ASSA ABLOY

4-7/8" Curved Lip Strike (Standard)

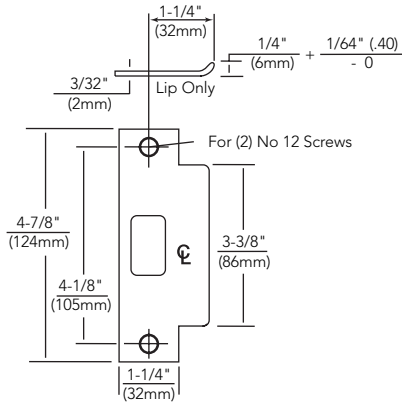

2-3/4" Curved Lip Strike (29- Option)

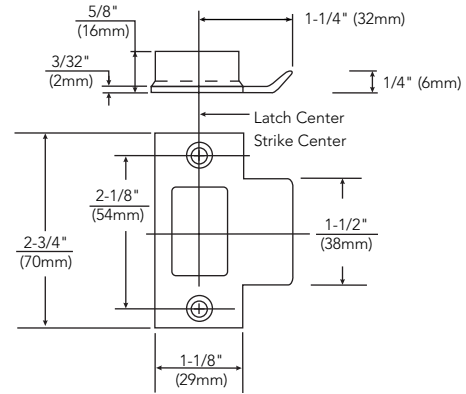

- Brass, bronze or stainless steel
- Conforms to ANSI standard
- Furnished standard with curved lip 1-1/4" (32mm) from center of strike screw holes to end of lip
- Lip lengths

7/8" (22mm)	1-5/8" (42mm)	2-5/8" (66mm)
1-1/8" (29mm)	1-7/8" (48mm)	2-7/8" (73mm)
1-1/4" (32mm)	2-1/8" (54mm)	3" (76mm)
1-3/8" (35mm)	2-3/8" (60mm)	
- 77-1141 Wrought strike box available separately
- To order strike separately, specify 808 strike x finish x lip length

- Brass, bronze or stainless steel
- Furnished standard with 1-1/4" (32mm) curved lip from center of strike screw holes to end of lip
- Lip lengths

1" (25mm)	1-3/4" (44mm)
1-1/4" (32mm) standard	2" (51mm)
1-1/2" (38mm)	3" (76mm)
- Plastic strike box AM-0044 included when 29- ordered with lockset
- To order strike separately, specify 800 strike x finish x lip length

Screw pack must be ordered separately, see page 6.

ANSI Wrought Strike Box

- Used with ANSI 4-7/8" (124mm) strike (#808)
- To order with lock, specify option WBS
- To order separately, specify 77-1141

Part No.	Description
77-1141	4-7/8" ANSI strike box

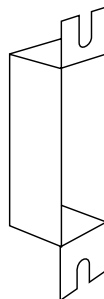

A8287.D 01/23

The warranty on SARGENT® products becomes void if the product is modified in any way, regardless of whether the modification causes or contributes to any alleged defect. If a SARGENT product is modified it may no longer meet industry certification and quality control standards applicable to the original product and is no longer a genuine SARGENT product.

Copyright © 2021, 2023 Sargent Manufacturing Company, an ASSA ABLOY Group company. All rights reserved. Reproduction in whole or in part without the express written permission of Sargent Manufacturing Company is prohibited.

Cylinders and Tailpiece Packs

10X Line Cylindrical Lever Locks



Brass, 6-pin
2 nickel silver keys
Finishes: 04, 15, BSP

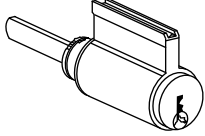

Fixed Core Cylinders for Mechanical Functions

Description	Cylinder	Door Thickness	Tailpiece Pack
Conventional, Signature, XC Degree® and competitor keyway	C10X-1 (Std.)	DG2-C10X-1	1-3/8" - 2"
	10-C10X-1	DG3-C10X-1	
	11-C10X-1	SC-C10X-1	2-1/4"
	DG1-C10X-1	SE-C10X-1	
	31-C10X-1	DG2-31-C10X-1	
Keso	10-31-C10X-1	DG3-31-C10X-1	1-3/8" - 2"
	11-31-C10X-1	SC-31-C10X-1	
	DG1-31-C10X-1	SE-31-C10X-1	2-1/4"
	F1-82-C10X-1	F1-82-31-C10X-1	
Hotel function	C10X-2	1-3/8" - 2-1/4"	N/A

Fixed Core Cylinders for Electrified Functions

Description	Cylinder	Door Thickness	Tailpiece Pack
Conventional, Signature, XC Degree® and competitor keyway	C10X-1E (Std.)	DG2-C10X-1E	1-3/8" - 2"
	10-C10X-1E	DG3-C10X-1E	
	11-C10X-1E	SC-C10X-1E	2-1/4"
	DG1-C10X-1E	SE-C10X-1E	
	31-C10X-1E	DG2-31-C10X-1E	
Keso	10-31-C10X-1E	DG3-31-C10X-1E	1-3/8" - 2"
	11-31-C10X-1E	SC-31-C10X-1E	
	DG1-31-C10X-1E	SE-31-C10X-1E	2-1/4"
	F1-82-C10X-1E	F1-82-31-C10X-1E	

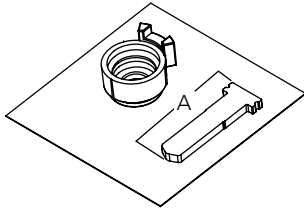

10-3629 (A=1.150")
10-3630 (A=1.313")

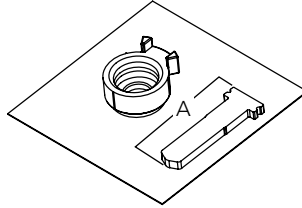

10-3637 (A=1.150")
10-3638 (A=1.313")

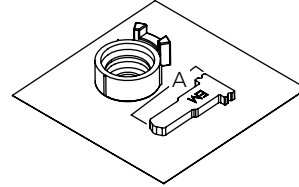

10-3791 (A=0.922")
10-3792 (A=1.085")

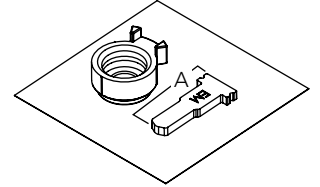

10-3793 (A=0.922")
10-3794 (A=1.085")

Large Format Interchangeable Core (LFIC) Mechanical and Electrified Functions

Brass, 6-pin
2 nickel silver keys
Finishes: 04, 15, BSP



Description	Core Model Number	Door Thickness	Tailpiece Pack for Use with Mechanical Functions	Tailpiece Pack for Use with Electrified Functions
LFIC conventional and Signature	6300 10-6300 DG1-6300	1-3/8" - 2"	10-3631	10-3773
		2-1/4"	10-3632	10-3774
LFIC XC	11-6300	1-3/8" - 2"	10-3635	10-3777
		2-1/4"	10-3636	10-3778

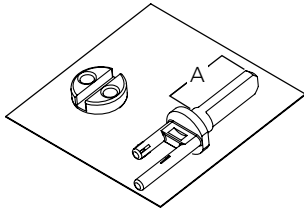

10-3631 (A=0.826")
10-3632 (A=0.989")

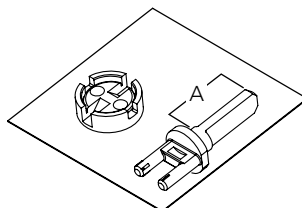

10-3635 (A=0.826")
10-3636 (A=0.989")

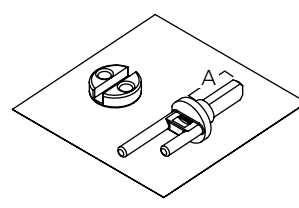

10-3773 (A=0.635")
10-3774 (A=0.798")

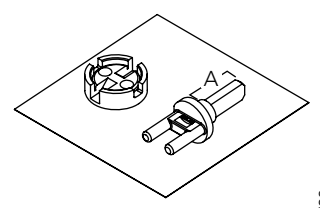

10-3777 (A=0.635")
10-3778 (A=0.798")

Experience a safer
and more open world

The warranty on SARGENT® products becomes void if the product is modified in any way, regardless of whether the modification causes or contributes to any alleged defect. If a SARGENT product is modified it may no longer meet industry certification and quality control standards applicable to the original product and is no longer a genuine SARGENT product.

Copyright © 2021, 2023 Sargent Manufacturing Company, an ASSA ABLOY Group company. All rights reserved. Reproduction in whole or in part without the express written permission of Sargent Manufacturing Company is prohibited.

Small Format Interchangeable Core (SFIC) for Mechanical and Electrified Functions

Brass, 6 or 7 pin
Finishes 04, 15

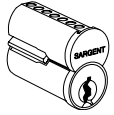

Description	Core Model Number	Door Thickness	Tailpiece Pack for Use with Mechanical Functions	Tailpiece Pack for Use with Electrified Functions
6-Pin SFIC	7300B	1-3/8" - 2"	10-3633	10-3775
7-Pin SFIC	7P-7300B	2-1/4"	10-3634	10-3776
XC	11-7P-7300B	1-3/8" - 2"	10-3641	10-3779
		2-1/4"	10-3642	10-3780

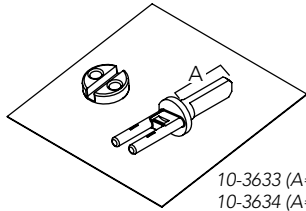

10-3633 (A=0.826")
10-3634 (A=0.989")

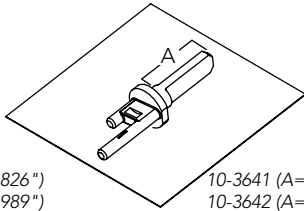

10-3641 (A=0.826")
10-3642 (A=0.989")

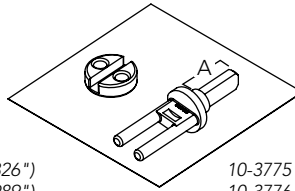

10-3775 (A=0.635")
10-3776 (A=0.798")

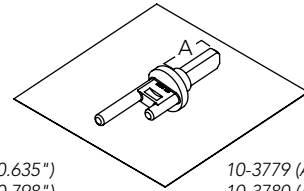

10-3779 (A=0.635")
10-3780 (A=0.798")

Compatibility with Competitive Cylinders/Cores*

Manufacturer	Cylinder Type	Door Thickness	Tailpiece Packs		Option Code with Lock	Description
			Mechanical Functions	Electrified Functions		
Fixed Core						
Schlage®	Fixed Core 6 Pin	1-3/8" - 2"	10-3625	10-3781	30-	For Schlage® 6 pin conventional cylinders (21-002, 23-001 or 23-013) or Schlage Primus cylinders (20-548, 20-550, 20-748 or 20-750). Option code with lock includes tailpiece.
		2-1/4"	10-3626	10-3782		
Yale®	Fixed Core 6- or 7- Pin	1-3/8" - 2"	10-3639	10-3783	YC- (6-Pin)	For Yale® 6 pin conventional cylinders (1803-46L/1803-46LL). Or 7 pin conventional cylinders (1803A-46L/1803A-46LL). Option code with lock includes tailpiece.
		2-1/4"	10-3640	10-3784	YC-7P- (7Pin)	
Interchangeable Core						
All	SFIC 6 or 7 Pin	1-3/8" - 2"	10-3633	10-3775	70-, 72-, 73-	For all SFIC 6 and 7 pin cores. Option code with lock includes special lever and tailpiece.
		2-1/4"	10-3634	10-3776		
Schlage®	LFIC 6 Pin	1-3/8" - 2"	10-3627	10-3789	SF-	For Schlage® 6 pin large format interchangeable cores. Option code with lock includes special lever and tailpiece.
		2-1/4"	10-3628	10-3790		
Yale®	LFIC 6 Pin	1-3/8" - 2"	10-1191	10-3787	YRC-	For Yale® 6 pin large format interchangeable cores. Option code with lock includes special lever and tailpiece.
		2-1/4"	10-1192	10-3788		

* Cylinder/core not included unless defined by option code.

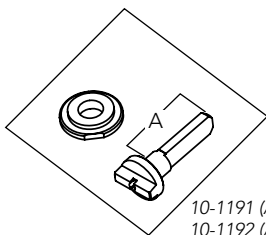

10-1191 (A=0.940")
10-1192 (A=1.103")

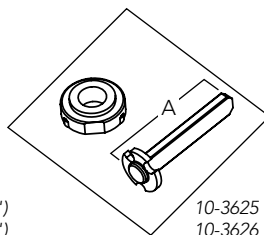

10-3625 (A=1.056")
10-3626 (A=1.280")

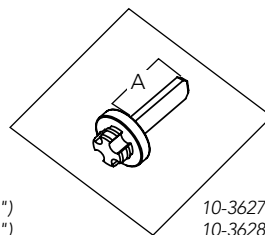

10-3627 (A=0.865")
10-3628 (A=1.028")

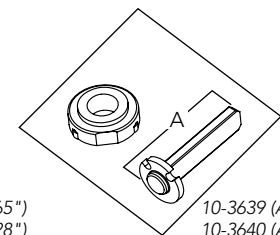

10-3639 (A=1.056")
10-3640 (A=1.280")

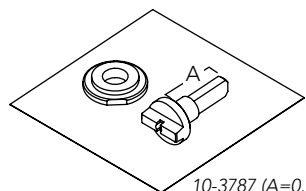

10-3787 (A=0.715")
10-3788 (A=0.878")

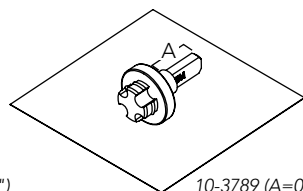

10-3789 (A=0.631")
10-3790 (A=0.794")

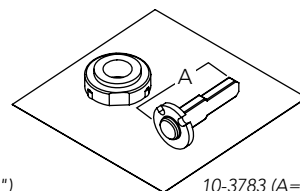

10-3783 (A=0.895")
10-3784 (A=1.058")

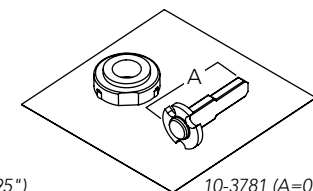

10-3781 (A=0.895")
10-3782 (A=1.058")

A8287.D 01/23

The warranty on SARGENT® products becomes void if the product is modified in any way, regardless of whether the modification causes or contributes to any alleged defect. If a SARGENT product is modified it may no longer meet industry certification and quality control standards applicable to the original product and is no longer a genuine SARGENT product.

Copyright © 2021, 2023 Sargent Manufacturing Company, an ASSA ABLOY Group company. All rights reserved. Reproduction in whole or in part without the express written permission of Sargent Manufacturing Company is prohibited.

Miscellaneous Cylinder Parts

10X Line Cylindrical Lever Locks

SARGENT

ASSA ABLOY

Part #	Description
10-1111	Spacer Only - Fixed Core Cylinder
10-1112	Spacer Only - Keso
10-1115	Spacer Only - LFIC/SFIC
10-1252	Hotel Adjustment Tool
10-0042	Lockout Key (50 Function)
C10X-3	Emergency Release Cylinder - Privacy/ Bathroom Function (65), 1-3/8" - 2" Doors
31-C10X-3	Emergency Release Cylinder - Privacy/Bathroom Function (65), 2-1/4" Doors

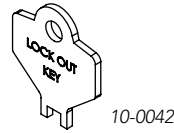
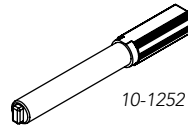

Identifying Tailpieces

10X Line cylinder tailpieces include stampings to help identify them.

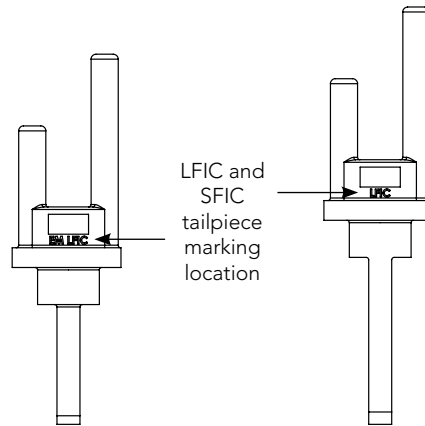
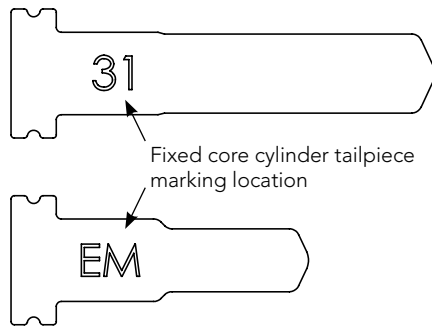

Experience a safer
and more open world

The warranty on SARGENT® products becomes void if the product is modified in any way, regardless of whether the modification causes or contributes to any alleged defect. If a SARGENT product is modified it may no longer meet industry certification and quality control standards applicable to the original product and is no longer a genuine SARGENT product.

Copyright © 2021, 2023 Sargent Manufacturing Company, an ASSA ABLOY Group company. All rights reserved. Reproduction in whole or in part without the express written permission of Sargent Manufacturing Company is prohibited.

Levers - Solid Cast Zinc

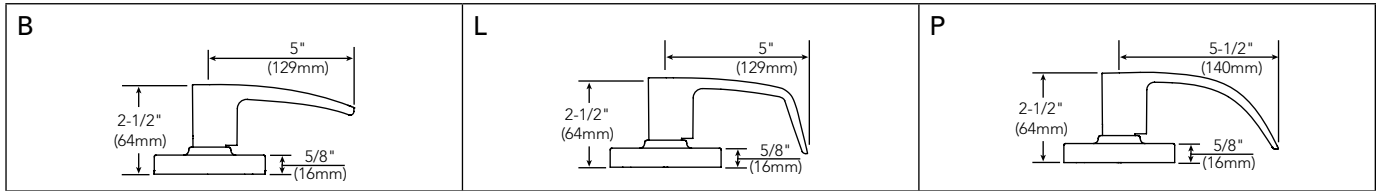

Decorative Levers

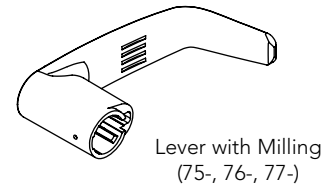
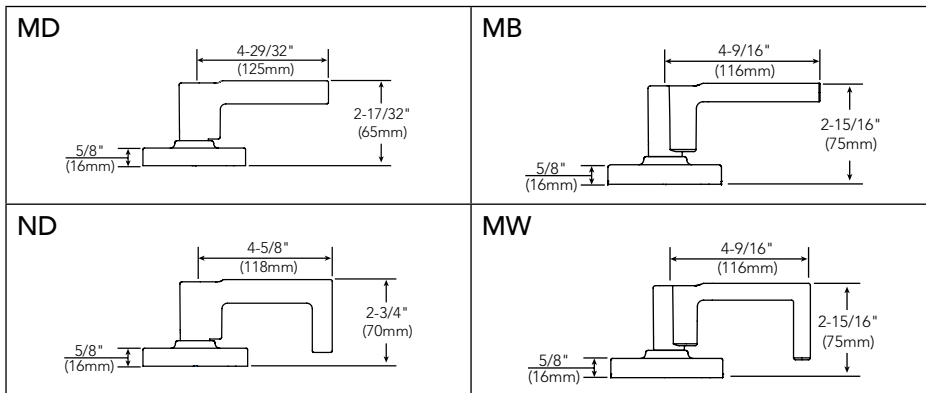

Levers for Doors 1-3/8" to 2-1/4" (Specify finish)

Application	B	L	P	MB	MD	MW	ND
Passage/plain	10-1121	10-1128	10-1137	10-1263	10-1240	10-1268	10-1245
Push/turn button, emergency release (65), fixed core cylinder (SARGENT® 6-pin)	10-1120	10-1127	10-1136	10-1264	10-1241	10-1269	10-1246
Thumbturn cylinder (68) includes cylinder	10-2424	10-2425	10-2427	10-2428	10-2429	10-2431	10-2432
Fixed core cylinder (Corbin Russwin 6/7-pin, Schlage® 6-pin, Yale® 6/7-pin)	10-1122	10-1129	10-1138	10-1265	10-1242	10-1270	10-1247
LFIC (SARGENT® 60-, 63-, 64-)	10-1123	10-1130	10-1139	10-1266	10-1243	10-1271	10-1248
LFIC (Schlage® 6-pin SF-)	10-1125	10-1132	10-1141	N/A	N/A	N/A	N/A
LFIC (Yale® 6-pin YRC-)	N/A	10-1134	10-1143	N/A	N/A	N/A	N/A
SFIC 6/7-pin (70-, 72-, 73-)	10-1124	10-1131	10-1140	10-1267	10-1244	10-1272	10-1249
KESO cylinder (SARGENT® 82-)	10-1126	10-1133	10-1142	N/A	N/A	N/A	N/A

Levers with Milling for Doors 1-3/8" to 2-1/4" (Specify finish)

Application	B	L	P	MB	MD	MW	ND
Passage/plain	10-1146	10-1153	10-1162	N/A	N/A	N/A	N/A
Push/turn button, emergency release (65), fixed core cylinder (SARGENT® 6-pin)	10-1145	10-1152	10-1161	N/A	N/A	N/A	N/A
Thumbturn cylinder (68) includes cylinder	10-2434	10-2435	10-2437	N/A	N/A	N/A	N/A
Fixed core cylinder (Corbin Russwin 6/7-pin, Schlage® 6-pin, Yale® 6/7-pin)	10-1147	10-1154	10-1163	N/A	N/A	N/A	N/A
LFIC (SARGENT® 60-, 63-, 64-)	10-1148	10-1155	10-1164	N/A	N/A	N/A	N/A
LFIC (Schlage® 6-pin SF-)	10-1150	10-1157	10-1166	N/A	N/A	N/A	N/A
LFIC (Yale® 6-pin YRC-)	N/A	10-1159	10-1168	N/A	N/A	N/A	N/A
SFIC 6/7-pin (70-, 72-, 73-)	10-1149	10-1156	10-1165	N/A	N/A	N/A	N/A
KESO cylinder (SARGENT® 82-)	10-1151	10-1158	10-1167	N/A	N/A	N/A	N/A

A8287.D 01/23

The warranty on SARGENT® products becomes void if the product is modified in any way, regardless of whether the modification causes or contributes to any alleged defect. If a SARGENT product is modified it may no longer meet industry certification and quality control standards applicable to the original product and is no longer a genuine SARGENT product.

How to Order Parts

1. In order to simplify the ordering procedure and maintain regulatory compliance, parts are only available as listed
2. To order parts, provide the appropriate quantity, part number, finish, hand (when required) and description as directed and illustrated below.

For example, use the following configuration to order:

- A) ten lockbodies in satin chrome
- B) one passage/plain L lever in bright brass

	Quantity	Part Number	Finish	Hand	Description
A	10	10-3588	26D	—	Entrance Function Lockbody
B	1	10-1128	03	—	Passage/Plain L Lever

For assistance, contact your authorized SARGENT distributor, sales agency or visit our website at www.sargentlock.com.

Finishes

SARGENT #	Descriptions	ANSI/BHMA
03	Polished brass, clear coated	605
04	Satin brass, clear coated	606
09	Polished bronze, clear coated	611
10	Satin bronze, clear coated	612
10B	Oxidized bronze, oil rubbed	613
10BE	Dark Oxidized Satin Bronze - equivalent	613E
10BL	Oxidized satin, bronze, clear coated	613L
14	Polished nickel, clear coated	618
15	Satin nickel, clear coated	619
20D	Statuary dark bronze, clear coated	624
26	Polished chrome	625
26D	Satin chrome	626
32D	Satin stainless steel (BHW only)	630
BSP	Black suede powder coat	BSP
WSP	White suede powder coat	WSP

Lock Finish	Cylinder/Core*
03, 04, 09, 10, 10B, 10BE, 10BL, 20D	04
14, 15, 26, 26D, 32D, WSP	15
BSP	BSP

*Finish when cylinder provided with lock

The ASSA ABLOY Group is the global leader in access solutions. Every day, we help billions of people experience a more open world.

ASSA ABLOY Opening Solutions leads the development within door openings and products for access solutions in homes, businesses and institutions. Our offering includes doors, frames, door and window hardware, mechanical and smart locks, access control and service.



SARGENT Manufacturing Company
100 Sargent Drive
New Haven, CT 06511 USA
800-727-5477
www.sargentlock.com

Founded in the early 1800s, SARGENT® is a market leader in locksets, cylinders, door closers, exit devices, electro-mechanical products and access control systems for new construction, renovation, and replacement applications. The company's customer base includes commercial construction, institutional, and industrial markets.

Copyright © 2021, 2023, Sargent Manufacturing Company, an ASSA ABLOY Group company. All rights reserved. Reproduction in whole or in part without the express written permission of Sargent Manufacturing Company is prohibited. Patent pending and/or patent www.assaabloydss.com/patents.