



1 Unpack box and make sure you have everything shown here.

Keypad Unit Gasket Slotted Screw (2x) Security Screw (2x) L Key

2 Prepare existing or install new single-gang junction box to which keypad unit will be mounted after wiring and testing.
(Junction box is not included.)

Continued on next page...

What's what?

Important components labeled

Wiegand Terminals
For wiring to Wiegand device.
See Page 2.

Reset Button
For performing unit reset procedure

Keypad Unit
Back of unit shown

WARNING

AUTOMATIC GATES CAN CAUSE SERIOUS INJURY OR DEATH!

ALWAYS CHECK THAT THE GATE PATH IS CLEAR BEFORE OPERATING!

REVERSING OR OTHER SAFETY DEVICES SHOULD ALWAYS BE USED!

3 Connect wires.

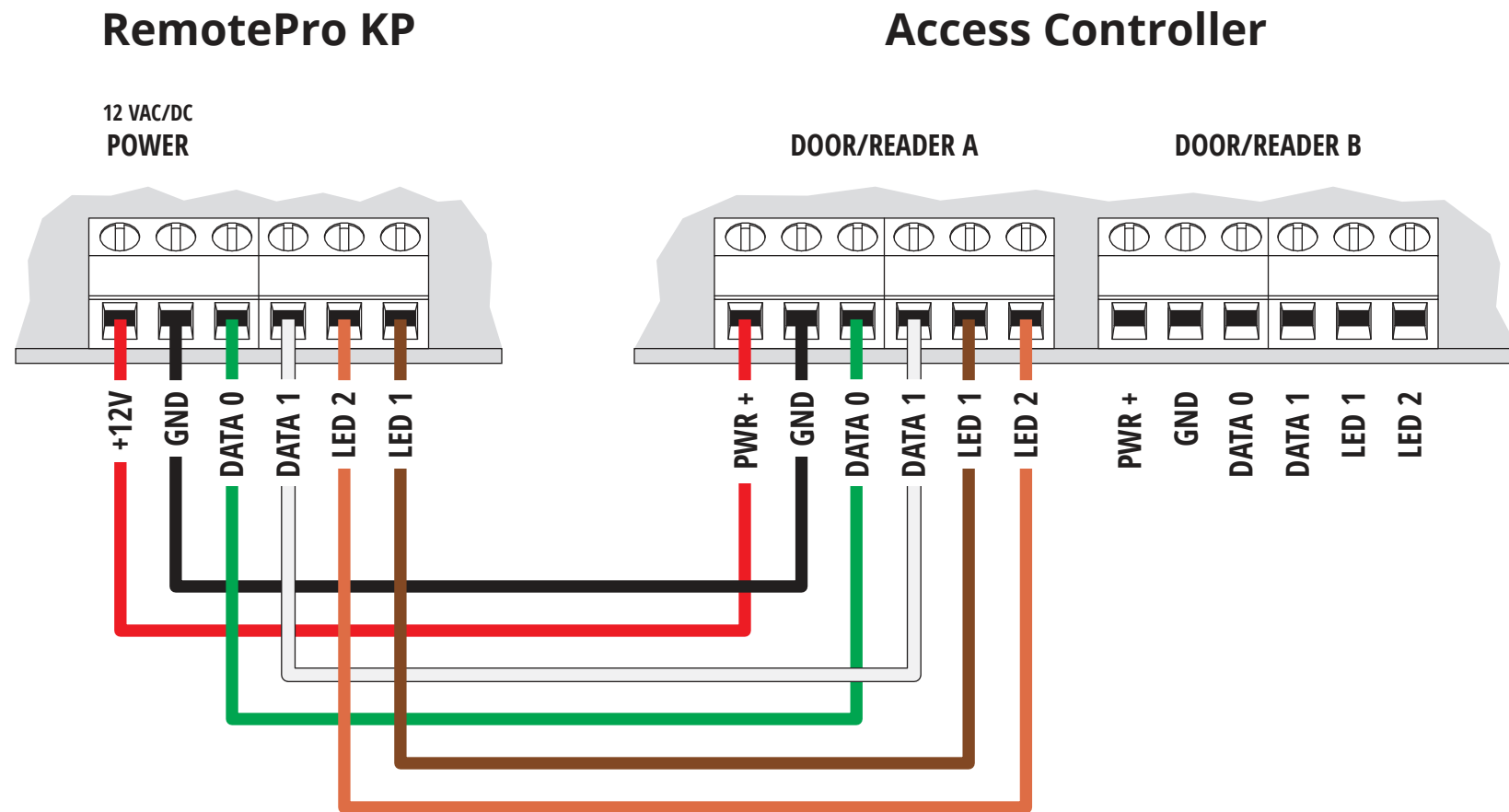

Programming Sub Modes

- 1 Set Facility Code
- 2 Change Master Code
- 3 Set Access Code Length (4 to 5 digits)
- 4 Toggle LED 2 On/Off
- 5 Toggle Backlit Keypad LEDs On/Off
- 6 Set Programming Timeout
- 7 Set Acknowledgment Timeout

4 Secure keypad unit to junction box using either set of included screws. (Gasket is optional if mounted indoors.)

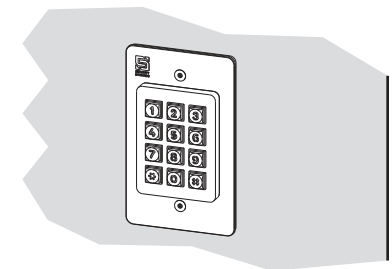

5 Set Facility Code. (Must be a valid code for the access controller being used. Default is 000.)

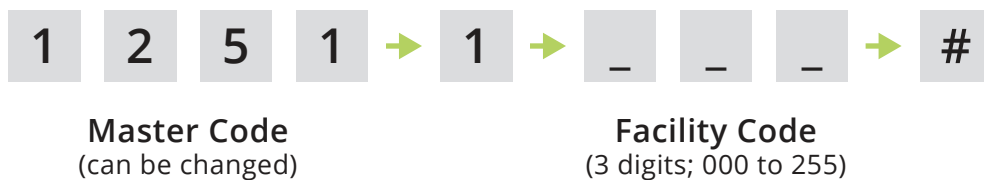

NOTE: Green arrow indicates "good" tone on keypad.

6 Set access code length. (Access codes may be either 4 or 5 digits in length. Default is 5.)

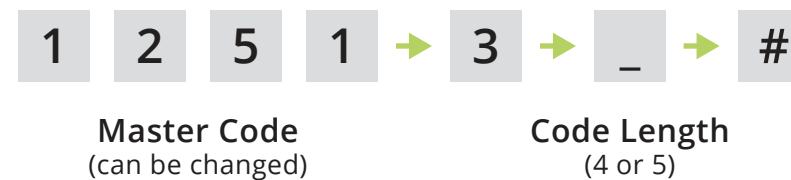

NOTE: Green arrow indicates "good" tone on keypad.



INSTALLATION COMPLETE!

Your system is ready to use.

Additional Programming

Model 12-000SGL

A Change Master Code (For added security, changing the default Master Code is recommended.)

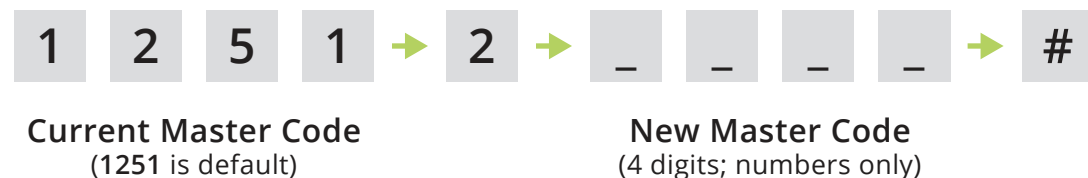

NOTE: The Master Code is for programming only and will not trigger the relay. The green arrow indicates a "good" tone on the keypad. An incorrect entry will sound a "bad" tone.

B Unit Reset Procedure

This procedure is used to reset unit to factory default settings.

Step 1 - Unscrew mounting screws with L Key and remove keypad unit from junction box.

Step 2 - Press and hold Reset Button for about 10 seconds. Unit will sound one (1) tone. Release Reset Button after you hear tone.

The unit is now reset to factory default settings.

Step 3 - Reinstall keypad unit in junction box and fasten mounting screws.

C Advanced Programming

Toggle LED 2 On/Off (Default is 1 for ON)

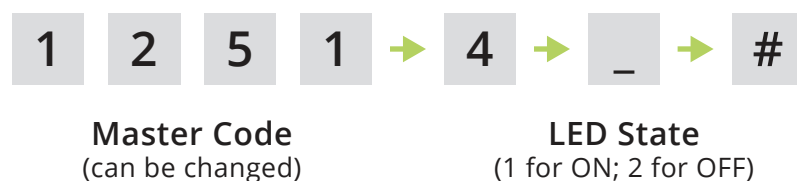

Toggle Backlit Keypad LEDs On/Off (Default is 1 for ON)

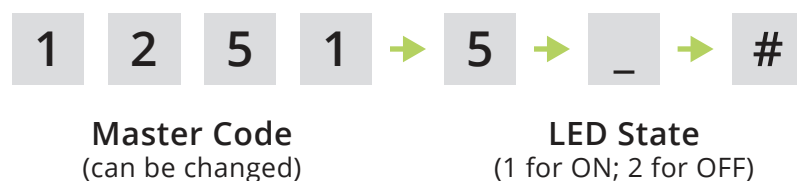

Set Programming Timeout (Unit will exit Programming Mode if no keys are pressed for period of time set. Default is 10.)

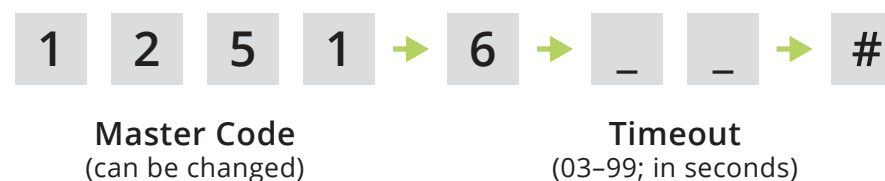

Set Acknowledgment Timeout (Unit will wait for this period of time to receive response from access controller. If no response is received, unit will sound "error" tone and status LED will flash. Default is 2.)



NOTE: Green arrow indicates "good" tone on keypad. Always wait for good tone before moving on.

Things to Know

The Star Key (*)

The star key deletes your current entry. If you happen to make a mistake keying in a code, simply press the star key to delete the entire entry and start over.

The Pound Key (#)

The pound key is good for one thing and one thing only: exiting Programming Mode. Whenever you want to exit Programming Mode, simply press the pound key.

