



EN ■ Bagless vacuum cleaner

Translation of the original manual

- This appliance may be used by children 8 years of age and older and by persons with physical or mental impairments or by inexperienced persons, if they are properly supervised or have been informed about how to use the product in a safe manner and understand the potential dangers.
- Children must not play with the appliance. Cleaning and maintenance performed by the user must not be performed by unsupervised children.
- In the event that the power cord is damaged, have it repaired at a professional service centre to prevent causing a dangerous situation. It is forbidden to use the appliance if it has a damaged power cord.
- Pull the power plug out of the socket before cleaning the appliance or performing maintenance.



WARNING:

Avoid coming into contact with the rotating parts of the vacuum cleaner's hand accessories. There is a risk of getting caught on these parts and possible injury.

- This vacuum cleaner is designed for use in households, offices and similar types of areas. Do not use in industrial surroundings.
- Do not submerge the vacuum cleaner under water or any other liquid and do not rinse it under running water.
- Before connecting the power cord to a power socket, check that the technical details on the vacuum cleaner's rating label match the electrical voltage in the socket.
- Make sure the power cord is not touching a hot surface or sharp objects.
- Do not submerge the vacuum cleaner under water or any other liquid and do not rinse it under running water.
- Before turning on the vacuum cleaner, make sure that all the inflow and outflow filters are installed in their place.
- When the vacuum cleaner is running, ensure that the air outlets and the suction hole are not blocked.
- Do not use the vacuum cleaner to vacuum the following items:
 - smouldering cigarettes, burning items, matches or embers;
 - water and other liquids;
 - flammable or volatile materials;
 - items, e.g. broken glass, needles, pins, etc.;
 - flour, wall plaster, cement and other building materials;
 - larger pieces of paper or plastic bags, which can easily block the suction hole.
- Vacuuming of some types of floors or floor surfaces can create an electrostatic discharge, which presents no danger to the user.
- Do not place the suction nozzle or tube against any parts of the face.
- Always turn off the vacuum cleaner and disconnect it from the power socket when leaving it without supervision, after finishing using it and before cleaning it.
- Disconnect the power cord from the power socket by pulling on the plug, never pulling on the cord. Otherwise, this could damage the power cord or the socket. It is recommended to hold the power cord in your hand when winding it up.
- If the power cord is damaged, have it replaced at a professional service centre. It is forbidden to use the vacuum cleaner if it has a damaged power cord.
- Do not use the vacuum cleaner if it is not working correctly, if it has been damaged or has been submerged in water. Do not repair the vacuum cleaner yourself or make any adjustments to it. Have all repairs or adjustments performed at an authorised service centre. By tampering with the appliance, you risk voiding your legal rights arising from unsatisfactory performance or quality warranty.

A

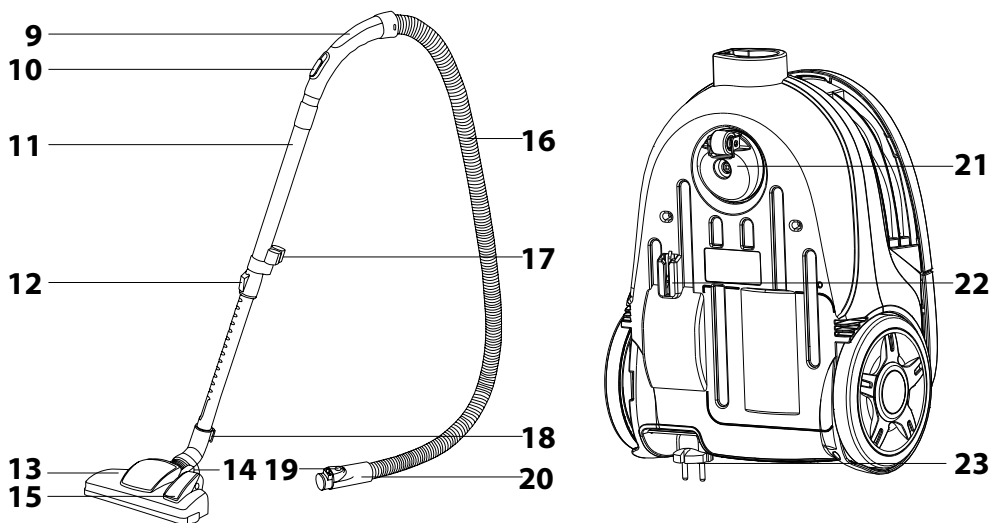
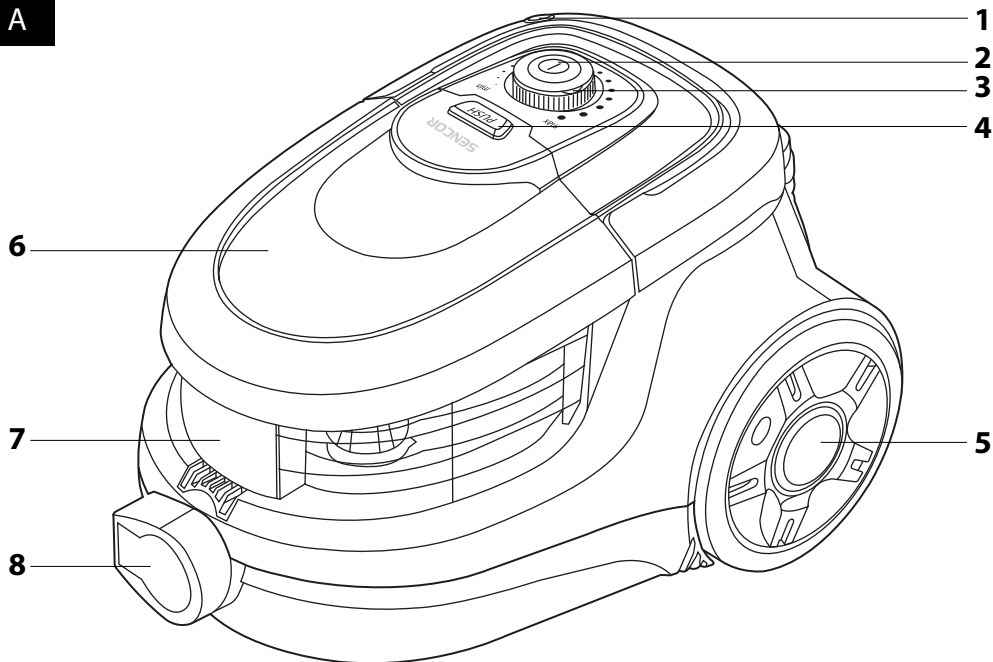

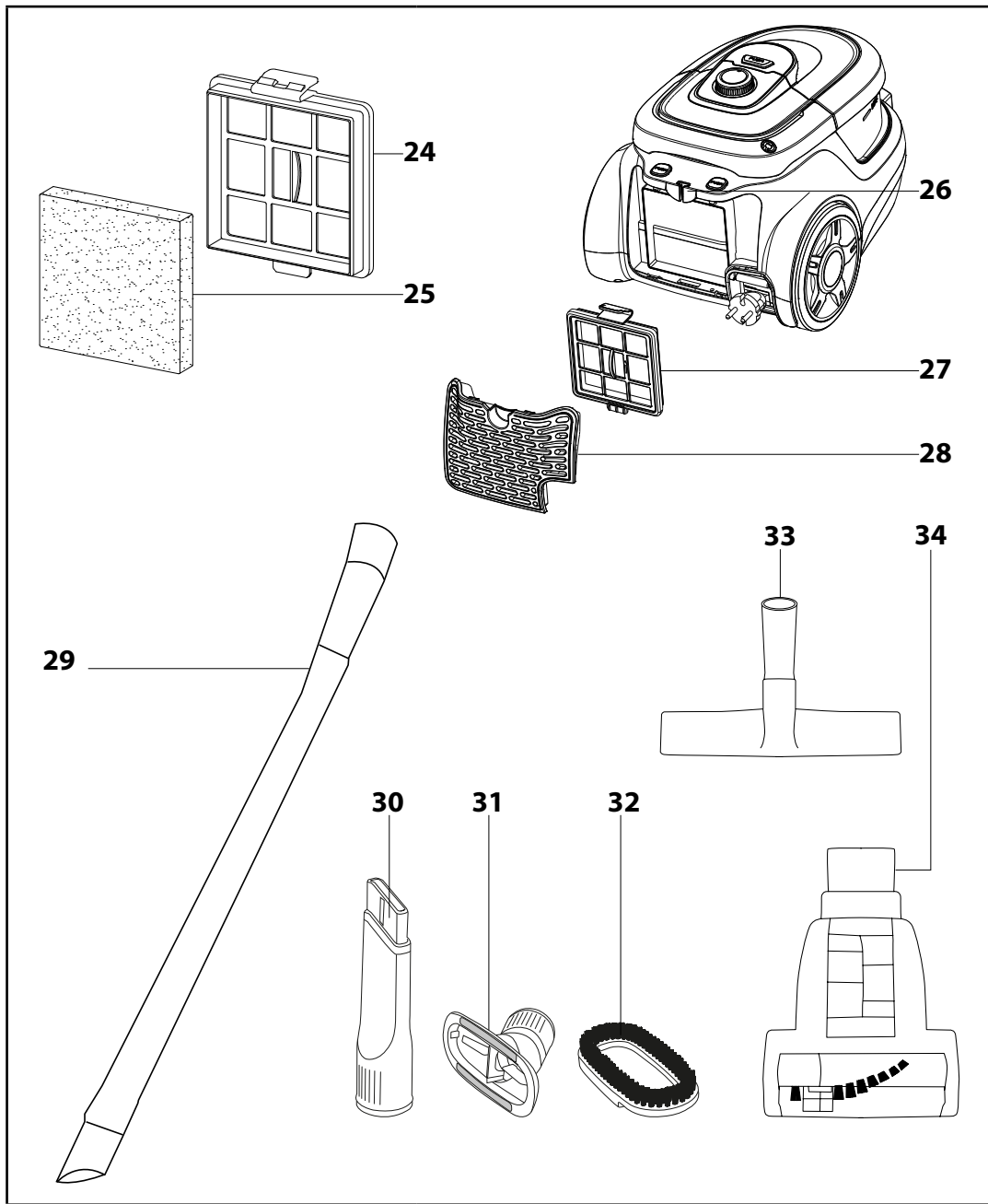

DESCRIPTION OF THE VACUUM CLEANER

A1 Cord winding button	A19 Clip
A2 On/Off button	A20 Hose end
A3 Suction power control knob	A21 Front travel wheel
A4 PUSH button (serves to release the dust container)	A22 Vertical parking position
A5 Rubber coated wheels	A23 Power cord
A6 Dust container lid	A24 Inflow filter
A7 Dust container	A25 Foam pre-filter
A8 Hose connection hole	A26 Horizontal parking position
A9 Handle	A27 Outflow filter
A10 Sliding flap for air suction	A28 Outflow filter protective grille
A11 Telescopic tube	A29 Long flexible crevice nozzle
A12 Telescopic tube position lock	A30 Crevice nozzle
A13 Combination floor nozzle	A31 Upholstery nozzle
A14 Flap position for vacuuming carpets	A32 Brush attachment (easy to attach to the upholstery nozzle for gentle vacuuming of fine upholstered surfaces)
A15 Flap position for vacuuming hard (smooth) floors	A33 Hard floor nozzle
A16 Hose	A34 Mini turbo brush
A17 Accessory holder	
A18 Stopper for the horizontal and vertical parking position	

ASSEMBLY

Inserting the hose into the air suction hole on the vacuum cleaner.

- Press both the clips on the end of the hose **A20** and insert it into the air suction hole **A8** on the vacuum cleaner until you hear a "click". The hose **A16** is now secured in the correct position.

Attach the holder to the telescopic tube:

- Make sure to place the holder with the hose on the wider part of the telescopic tube **A11**.

Attach the floor nozzle to the telescopic tube:

- Make sure that the floor nozzle **A13** is attached to the narrower part of the telescopic tube **A11**.

Adjust the length of the telescopic tube:

- Adjust the length of the telescopic tube **A11** as required – disengage and hold the clip **A19** on the tube in the direction shown by the arrow and adjust the length of the tube **A11** as required. Then release the clip **A19** and slide out the tube **A11** slightly forward until you hear a "click". The telescopic tube **A11** is now securely locked in position.

USING THE VACUUM CLEANER

Connecting the vacuum cleaner to the power grid

- Wind out the required length of the power cord by pulling on the power plug. Insert the power plug into a power socket.



Attention:

The yellow marking on the power cord warns you that the power cord is close to its end. Do not pull the cord farther than the red marking.

Adjusting the floor inlet nozzle according to the floor surface.

- You may set the inlet nozzle according to the floor surface by adjusting the inlet flap:
 - If you want to vacuum carpets, move the flap to retract the bristles.
 - If you want to vacuum hard and smooth surfaces, move the flap to extend the bristles.

Turning your vacuum cleaner on and off

- To turn on the vacuum cleaner, press the On/Off button **A2**. To turn off the vacuum cleaner, press the button **A2** again.

Adjusting the suction power

- Suction can be controlled using the control knob **A3**. Turning clockwise (towards MAX) increases the power of the vacuum cleaner, turning anticlockwise (towards MIN) reduces the power. In a smaller range, you may regulate suction power using the mechanically sliding flap **A10** on the hose handle.

TIPS

- Use the maximum suction power when vacuuming carpets or floors with a hard surface. Use the reduced strength when vacuuming upholstery, window curtains, etc.
- If the hose holder becomes blocked when vacuuming, disconnect it from the telescopic tube and also disconnect the hose from the vacuum cleaner body. Then place the holder inside the suction hole on the vacuum cleaner body and vacuum the stuck dirt out.

Temporary interruption of the vacuuming process

- If you wish to interrupt vacuuming for a while, you can use the horizontal **A26** or vertical **A22** parking position on the vacuum cleaner, into which you insert the stopper **A18** on the floor nozzle.



Attention:

Do not move the vacuum cleaner from place to place if the hose is in the parked position! The stopper on the floor nozzle could brake off.

Ending the vacuuming process

- When you finish vacuuming, switch the vacuum cleaner off by pressing the On/Off button **A2** and then disconnect the power cord plug from the power socket.
- To wind the power cord back into the vacuum cleaner, press and hold the winding button **A1** with one hand and guide the power cord with the other.

TIP:

- If the winding process stops and part of the power cord is still outside, release the winding button **A1** and pull the cable out again by about 50 cm and then press and hold the winding button **A1** again and repeat the winding process.

USING THE ACCESSORIES

- The combination floor nozzle **A13** for hard floors ensures perfect and yet gentle vacuuming of smooth hard surfaces thanks to the brush being from 100 % natural bristles. It can be used to vacuum floors that are sensitive to scratching such as wooden or floating floors, marble floors, tiles, linoleum, etc.
- The long flexible crevice nozzle **A29** serves to vacuum very hard-to-reach places anywhere in your car.
- The crevice nozzle **A30** is suitable for vacuuming hard to reach places (e.g. window frames, libraries, upholstery corners, joints, etc.).
- The hard floor nozzle **A33** ensures perfect and yet gentle vacuuming of smooth hard surfaces thanks to the brush being from 100% natural bristles. It can be used to vacuum floors that are sensitive to scratching such as wooden or floating floors, marble floors, tiles, linoleum, etc.
- The mini turbo brush **A34** is the ideal helper for removing animal fur, hair, etc., while at the same time being suitable for vacuuming hard-to-reach places. Its use is not limited to the home, and can be used for vacuuming the car. It quickly and effectively removes hair, animal fur and other materials from car seats, upholstery, pillows and other textile surfaces.

TIP:

- If during vacuuming you use an accessory very often, you may attach it to the special holder on the telescopic tube.

CLEANING AND MAINTENANCE



Attention:

Before cleaning, disconnect this appliance from the power source.

Emptying the dust container

- Empty the dust container **A7** as soon as it fills up to the MAX mark; otherwise the air flow and the suction power will be reduced. Nevertheless, it is recommended to always empty out the dust container when you have finished vacuuming.

- Take out the hose **A16**.
- Press the PUSH **A4** button and pull out the dust container **A7** upwards.
- Remove the lid of the container **A6** and take out the dust filter. Tip the dust out of it and rinse it out under lukewarm running water if necessary.
- Take the dust container **A7** above a waste bin and turn it upside down to shake the dirt and dust out of it. If it is heavily soiled you may wash the entire container under running lukewarm water. It is, however, necessary to first remove the inflow filter **A24** and its foam pre-filter **A25** before doing this!
- Insert the dust filter into the dust container **A7** and put on the lid **A6**.
- Insert the container **A7** into the vacuum cleaner.



Attention:

Make sure that all parts are completely dry before reinserting the dust container **A7** and the dust filter back into the vacuum cleaner.

Replacing and cleaning the inflow filter and the foam pre-filter

1. Press the PUSH **A4** button and pull out the dust container **A7** upwards.
2. Fold out both safety clips of the inflow filter frame **A24**, take it out of the dust container **A7** and from behind it also remove the foam pre-filter **A25**.
3. Wash both filters under running lukewarm water and if necessary replace with new ones.
4. Then first reinsert the foam pre-filter **A25** and then the inflow filter **A24** until you hear both clips click in.
5. Place the dust container **A7** back into the vacuum cleaner.



Attention:

Never insert the filters back into the vacuum cleaner if they are wet or damp! Always wait until they are thoroughly dry.

Replacing the outflow filter

- First remove the grill of the outflow filter **A28** by pulling it away from the vacuum cleaner in the location of both safety clips.
- Then remove the outflow filter **A27** and replace it with a new one.
- After reinserting the filter **A27**, put on the grille of the outflow filter **A28** and click it in behind both the clips.



Attention:

Make sure you put the outflow filter **A27** in the vacuum cleaner with the plastic grill facing outwards!

Cleaning the vacuum cleaner

- To clean the outside parts of the appliance use a fine cloth dipped in lukewarm water. Do not use aggressive cleaning agents, paint thinners or solvents. Using these solutions could damage the surface of the appliance.

TROUBLESHOOTING

- Before you decide to contact an authorised service centre, please read through the following table:

Problem	Possible cause	Solution
The motor will not start	- The power cord is not inserted correctly in the power socket. - The power socket is damaged. - The vacuum cleaner is not switched on.	- Insert the plug firmly into the power socket - Inspect the power socket. - Turn on the vacuum cleaner.
Suction power is weak	- The appliance is clogged. - The dust filter needs cleaning. - The dust container is not in the correct position. - The filter is clogged.	- Remove the blockage or foreign object. - Clean out the dust filter. - Close the dust container. - Clean out the filter.
The power cord is not wound in completely.	The power cord may have slipped down from the winding pulley during winding.	Hold the cable under tension while winding the cable.
The cable cannot be pulled out.	The cable is wound up incorrectly.	Press the winding button of the self winding cable and try to rewind the power cord again
Suction power control does not work.	The appliance is out of order.	Contact an authorised service centre.
The power cord starts to wind in when it is not required.	The winding mechanism is damaged.	Contact an authorised service centre.
The dust container cannot be closed.	The dust filter is inserted incorrectly or in an incorrect position.	Reinstall and secure the filter in position and try again.

TECHNICAL SPECIFICATIONS

Rated voltage.....	220 – 240 V ~
Rated frequency.....	50 / 60 Hz
Rated power input.....	750 W
Safety class (with regard to electrical shock protection).....	II
Noise level.....	75 dB(A)
Length of power cord.....	7 m
Operating range.....	10 m
Dust container capacity.....	1.1
Dimensions (length x width x height).....	380 x 280 x 255 mm
Weight.....	4,75 kg

The declared noise emission level of the appliance is 75 dB(A), which represents a level A of acoustic power with respect to a reference acoustic power of 1 pW. Changes to text and technical parameters reserved.

INSTRUCTIONS AND INFORMATION REGARDING THE DISPOSAL OF USED PACKAGING MATERIALS

Dispose of used packaging material at a site designated for waste in your municipality.

DISPOSAL OF USED ELECTRICAL AND ELECTRONIC EQUIPMENT



This symbol on products or original documents means that used electric or electronic products must not be added to ordinary municipal waste. For proper disposal, renewal and recycling, hand these products over to determined collection points. Alternatively, in some European Union states or other European countries you may return your appliances to the local retailer when buying an equivalent new appliance.

Correct disposal of this product helps save valuable natural resources and prevents potential negative effects on the environment and human health, which could result from improper waste disposal. Ask your local authorities or collection facility for more details.

In accordance with national regulations penalties may be imposed for the incorrect disposal of this type of waste.

For business entities in European Union states

If you want to dispose of electric or electronic devices, ask your retailer or supplier for the necessary information.

Disposal in other countries outside the European Union.

This symbol is valid in the European Union. If you wish to dispose of this product, request the necessary information about the correct disposal method from the local council or from your retailer.



This product meets all the basic requirements of EU directives related to it.