

SENCOR®

SES 1720WH
SES 1721BK



PORTAFILTER COFFEE MACHINE

Translation of the original manual



SENCOR®

**SES 1720WH
SES 1721BK**



A

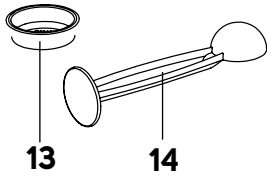
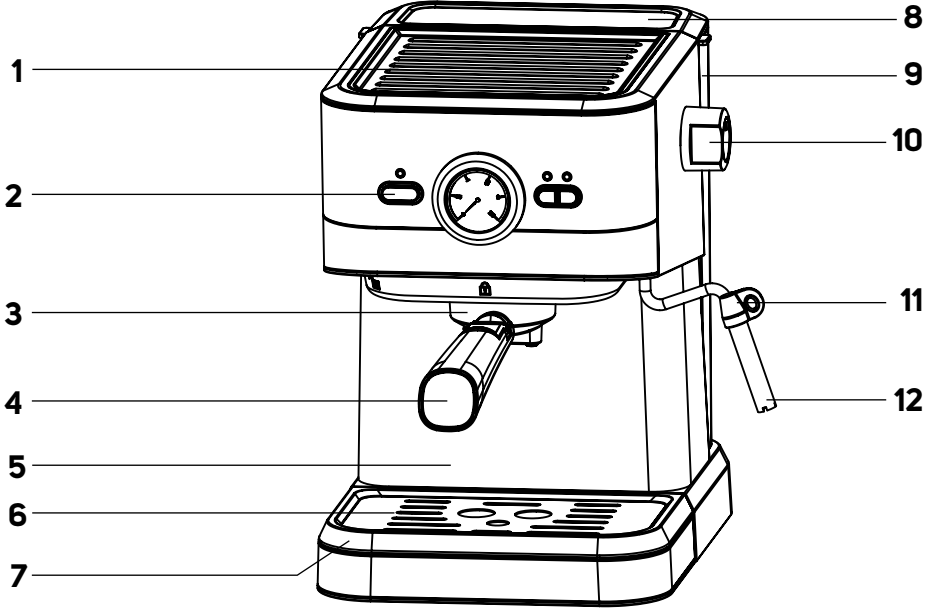

B

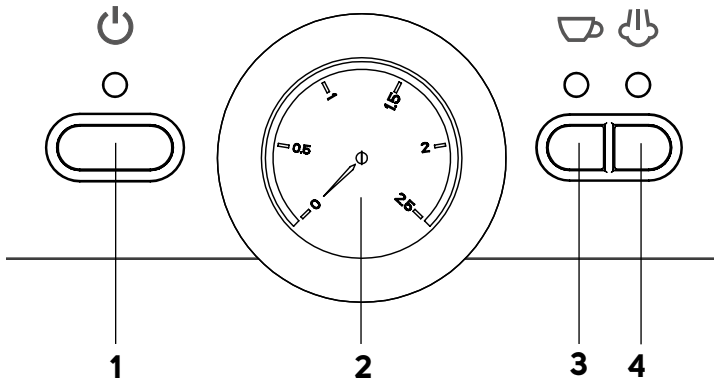

EN Portafilter Coffee Machine

Important Safety Instructions

READ CAREFULLY AND STORE FOR FUTURE USE.

- This appliance may be used by children 8 years of age and older and by persons with physical, sensory or mental impairments or by inexperienced persons, if they are properly supervised or have been informed about how to use of the product in a safe manner and understand the potential dangers.
- Children must not play with the appliance.
- Cleaning and maintenance performed by the user must not be performed by unsupervised children.
- Keep the appliance and its power cord out of reach of children younger than 8 years of age.
- If the power cord is damaged, have it replaced in a professional service centre in order to prevent a dangerous situation. It is forbidden to use the appliance with the power cord damaged.
- This appliance is intended for use in the home. The appliance is also designed for personal non-commercial use in areas that include, but are not limited to the following:
 - kitchenettes in stores, offices and other workplaces;
 - agricultural farms;
 - by guests in hotels, motels and other residential areas;
 - bed and breakfast establishments.

- The appliance must not be immersed in water during cleaning.



WARNING:

The filling hole must not be opened during use.



WARNING:

Avoid spilling on the plug.

Always clean the parts of the appliance that come into contact with food with clean warm water and a little neutral dishwashing liquid, rinse them with clean water and wipe dry.



WARNING:

The outer surface of the appliance heats up during use and may be hot for some time after use. Be very careful.

The appliance must not be placed in a cabinet when in use.

Electrical Safety

- Before connecting the appliance to a power outlet, make sure that its nominal voltage indicated on the rating plate matches the electrical voltage of the socket.
- Connect the appliance only to a properly grounded socket. For safety reasons, we don't recommend using adaptor plugs or extension cords.
- Do not place the appliance on windowsills, sink drain trays or unstable surfaces. Always place the appliance on a stable, flat and dry surface.
- Do not place the appliance on an electric or gas stove or near an open flame.
- Never use the appliance in the immediate vicinity of a bath, shower or swimming pool.
- Use the appliance only for the purpose for which it has been designed.
- Only use the appliance with the original accessories supplied with it.
- During operation, a clear space of at least 15 cm must be left around and above the appliance to ensure sufficient air circulation.
- Only use the top surface of the appliance for warming cups. Do not use it to store items.
- Fill the water tank with clean, cold water. Do not pour hot water or other liquids into it or place any objects inside it.
- Before turning on the appliance, make sure that:
 - the drip tray with grid is installed in its place;
 - the water tank is filled with a sufficient amount of water and is properly installed in its position;

Safety in Use

- The water level must not exceed the maximum mark.
- Before you begin brewing coffee, check that the portafilter is properly attached to the brew head. Pressure is created in the portafilter during the coffee brewing process, so do not move it during operation. Otherwise a dangerous situation could arise.
- Take extra care when operating the appliance to avoid scalding with hot water or steam.
- When using the appliance, check the water level in the water tank regularly. If the water level falls below the minimum mark, refill the water tank. Before adding water, first turn off the appliance and disconnect it from the power socket.

- The appliance is equipped with a built-in thermal fuse that shuts it off when the pump is idling to prevent damage. If such a situation occurs, unplug the power cord and allow the appliance to cool down for at least 30 minutes. Then you can use it again.
- Always turn the appliance off and disconnect from the power socket if it's to be unused or left unattended, before disassembling or assembling, before filling the hopper or before moving or cleaning. Allow the appliance to fully cool down before cleaning or moving.
- Do not move the appliance with a cup of coffee placed on the drip tray grid or with cups placed on the surface designed to warm them up.
- Keep the appliance and its accessories in clean condition. Perform the cleaning and maintenance in accordance with the instructions in chapter Cleaning and maintenance. Never wash the appliance under running water or submerge it in water or another liquid.
- Ensure that the power cord does not come into contact with a hot surface or that the power cord plug is not spilled.
- Unplug the appliance from the power socket by pulling the plug, not the power cord. Otherwise, damage to the power cord or the socket may occur.
- To avoid the danger of injury by electrical shock, do not repair or modify the appliance yourself. Have all repairs or adjustments performed at an authorised service centre. By tampering with the appliance, you expose yourself to the risk of losing your legal rights regarding faulty performance or warranty for quality.

Portafilter Coffee Machine



User Manual

- Thank you for purchasing our SENCOR product; we hope you will be satisfied with it.
- Before using this appliance, please familiarise yourself with the user manual, even if you are already familiar with using similar types of appliances. Use the appliance only as described in this user manual. Keep the manual for future reference.
- For the duration of the legal rights regarding faulty performance or warranty for quality, we recommend keeping the original packaging, packaging materials, receipt, and proof of the seller's liability or warranty certificate. When transporting the appliance, we recommend packaging it again in the original box provided by the manufacturer.

DESCRIPTION OF THE COFFEE MACHINE

A1 Cup warming plate	A9 Water tank
A2 Control panel	A10 Steam / hot water dispenser control
A3 Brew head	A11 Steam nozzle
A4 Portafilter	A12 Steam nozzle attachment
A5 Coffee machine body	A13 Baskets (for 1 and 2 cups)
A6 Drip tray grid	A14 Coffee measuring scoop with tamper
A7 Drip tray	
A8 Water tank lid	

DESCRIPTION OF THE CONTROL PANEL

B1 Button  to switch the coffee machine on/off	B3 Coffee brewing button 
B2 Temperature indicator	B4 Steam dispenser button 

BEFORE FIRST USE

- Before first use, remove the appliance and its accessories from the packaging and remove all promotional labels and tags. Check that neither the appliance nor any of its components is damaged.
- Place the coffee machine on a flat, dry and clean surface. Make sure there is a clear space around the coffee machine, at least 35 cm above it and 15 cm on the sides. Wipe the outer surface of the appliance with a slightly dampened sponge and then wipe dry.
- Remove the water tank from the appliance. Rinse it with clean water and a small amount of neutral dishwashing detergent. Then rinse thoroughly with clean water, dry and put back into the machine.
- Remove the removable drip tray with grid, wipe with a dampened sponge, dry and put back into the base of the appliance.
- Wash the portafilter, coffee measuring scoop and stainless steel baskets under clean running water with a little kitchen detergent. Then rinse with clean water and dry.

PREPARING BEFORE USE

Drip Tray

- The drip tray with a grid catches drops of brewed coffee when the portafilter is removed, hot water drained from the boiler after frothing to avoid burning the coffee, and any spilled milk during frothing. Therefore, make sure that both parts are correctly installed and inserted into the appliance.
- We recommend emptying the appliance and washing the drip tray after each use. When washing, follow the instructions in the chapter "Cleaning and maintenance".



Note:

The drip tray is equipped with a fullness indicator. It is a float. When the liquid level in the drip tray pushes it up, the drip tray must be emptied.

Filling the Water Tank

- Open the lid of the water tank. Hold the water tank by the grip and remove it upwards. Fill it with cold drinking water up to the max water level mark, put it back in and fold the grip into the water tank. Then close the lid of the water tank. The water tank must be properly seated in its place so that water can be pumped from it to the boiler.



Note:

The water that you pour into the water tank should ideally be at room temperature (approximately 25°C). Water that is too cold can adversely affect the final taste of the coffee drink. Do not leave the remaining water in the water tank for more than one day. For brewing quality fresh coffee, it is necessary to use fresh water. Otherwise, the final taste of the coffee drink may be adversely affected.



Warning:

The maximum capacity of the water tank is 1.4 l. Do not overfill it. Never fill the water tank with warm, hot or sparkling water or liquids such as milk. Do not fill the water tank when it is inserted in the appliance. There is a risk of spilling the appliance or overflowing the water tank.

Inserting and Removing the Basket

- Insert the selected stainless steel basket in the portafilter and push firmly.
- To remove the basket from the portafilter, press the button on the handle of the portafilter and the basket will be released. Then you can take it out.

Filling the Basket and Tamping the Coffee



- Place the portafilter on a flat surface and pour an appropriate amount of ground coffee into basket. A basket for one cup of coffee is filled with one level measuring scoop of ground coffee. A basket for two cups of coffee is filled with twice the amount of coffee. One aligned scoop is equivalent to about 7 g of ground coffee. Spread the coffee in the basket evenly and squeeze it with the flat end of the measuring scoop.
- Clean the edges of the basket thoroughly of any ground coffee residue.



Note:

Use only ground coffee designed for use in espresso machines. Do not use ground coffee intended for use in a French press, drip machine, etc.

Portafilter Installation and Removal

- Place the portafilter underneath the brew head so that the grip is pointing to the left and aligned with the "" icon on the brew head. To attach the portafilter to the brew head, turn the grips to the right to the position indicated by the "" icon.
- To remove the portafilter from the brew head, turn the grip clockwise to the "" icon. Remove it from the brew head and move it above a rubbish bin. Turn the portafilter so that the basket with the spent coffee points downwards. Use a coffee spoon to remove the coffee grounds. Avoid contact with the surface of the basket or portafilter as it may still be heated. Before taking the basket out of the portafilter, cool it under cold running water. Then rinse the basket and the portafilter under clean running water and dry them thoroughly.





Cup Warming

- As soon as you switch the appliance on with the  button, the cup warming area starts heating automatically. Place empty coffee cups (upside down) on to area A7 and allow them to warm up.

USING THE COFFEE MACHINE

- Place the coffee machine on a flat, dry and clean surface at a sufficient distance from the power socket. Ensure there is enough space around it for manipulation, at least 15 cm around the entire coffee machine.
- Make sure that the water tank is refilled with fresh water and that the bean hopper has an adequate amount of coffee beans and that the appliance is properly assembled.
- Connect the power cord plug to a power socket.

Turning on the Coffee Machine, Rinsing and Preheating

- Place a cup or bowl under the coffee spout.
 - Press the button  to turn the appliance on. The power button light turns red and the machine starts to preheat.
 - As soon as the coffee brewing button light turns green, the machine is ready for use.
 - Press the  button and the coffee machine will start pumping water into the internal system. Allow the water to draw in and flow out through the spout. This will clean and heat the inner circuit and the coffee spout. Pour the water out of the cup or bowl and repeat the process about three times.
 - Direct the steam nozzle into the cup or bowl. Carefully turn the steam / hot water dispenser control until water starts flowing through the steam nozzle. Let the water flow for about 30 seconds, then turn the control to the OFF position.
 - Now the coffee machine is ready for use.
- The button  will not function until the coffee machine is sufficiently preheated.
 - If the cup or bowl is already too full, press the  button while the machine is dispensing water and the water dispensing will stop. You can empty the cup or bowl.



Warning:



Be careful during flushing as the water discharged through the spout and steam nozzle is very hot and improper handling can cause scalding.



Note:

The sound of the pump is heard during coffee brewing, steam/hot water dispensing and rinsing. This is a normal occurrence.



Coffee Preparation

- The appliance is supplied with 2 stainless steel baskets: a basket for 1 cup of coffee and a basket for 2 cups of coffee.
 - The 1-cup basket is suitable for making 1 espresso, regular cappuccino or latte macchiato.
 - The 2-cup basket is suitable for making a double espresso, 2 espressos, strong cappuccino or latte macchiato.
- Insert the 1-cup or 2-cup basket in the portafilter, fill the coffee and insert the handle in the brew head.
 - Make sure the coffee machine is preheated.
 - Place a cup or mug under the portafilter.
 - Press the  button. The indicator light of the button lights up.
 - First, the coffee is brewed by releasing a small amount of water into the basket to swell the ground coffee in the basket. After a while, the full extraction of the coffee is started.
 - If you have inserted the 1-cup basket into the portafilter, it is necessary to stop the coffee dispensing by pressing the  button once the desired amount of coffee has flowed into the cup.
 - If you have inserted the 2-cup basket in the portafilter, the dispensing will stop automatically. The coffee machine is programmed to dispense a quantity of coffee for 2 cups (60 ml).



- Remove the portafilter from the brew head and clean it according to the instructions in the "Cleaning and Maintenance" section. We recommend waiting about 5 seconds before removing the portafilter from the brew head. This will naturally release the pressure and make it easier to remove the portafilter.

Dispensing Hot Water

Hot water can be used to heat cups, prepare tea, etc.

- Place a cup under the steam nozzle.
- When the coffee machine is preheated, press the  button and the pump will start pumping water.
- At this point, turn the steam / hot water dispenser control to the  position and hot water will start flowing out of the steam nozzle.
- Once the desired amount of hot water has flowed into the cup, press the  button again and turn the steam/hot water dispenser control to OFF.

Milk Frothing

- Prepare cooled semi-skimmed or whole milk and a container in which to whisk the milk. Whisking causes the milk to froth, so fill the container to no more than 1/3 of its capacity.
- Adjust the nozzle to a position where you can whisk the milk comfortably.
- Make sure the steam / hot water dispenser control is set to the OFF position. Press the button  and wait for the button light to come on. This signals that the water in the boiler has reached the optimum temperature for steam production. This is higher than the temperature for coffee extraction.
- Set the steam / hot water dispenser control to the  position and let the steam escape for about 10 to 15 seconds to clean the steam nozzle and remove any excess water that may have accumulated during heating. Then turn the control to the OFF position.
- Place the container with milk underneath the nozzle. Insert the nozzle just below the milk level and set the OFF control to . The nozzle will start releasing steam.
- Hold the container slightly tilted to ensure that the nozzle remains constantly submerged just under the surface of the milk. The milk will circulate in the container, it will heat up and increase in volume. Milk froth will start to form on the surface of the milk.
- When the bottom of the container is heated to the point where it is hot to the touch, stop whisking by turning the control to OFF. When steam stops being created, remove the container. Using a swirling motion, whip the froth into the heated milk.



Warning:

During whisking, the nozzle must always be immersed. Otherwise hot milk may splash out.

- Pour the frothed milk into freshly brewed coffee and use a spoon to add the milk froth. The recommended milk-to-coffee ratio for making cappuccino coffee is 1/3 espresso, 1/3 warm milk and 1/3 milk froth. To make a latte macchiato, use 1/2 espresso, 1/4 warm milk and approximately 1 cm of milk froth.
- After using the hot steam function, allow the coffee machine to cool for about 5 minutes or drain the rest of the hot water from the boiler to prevent the coffee from boiling with water heated to a temperature that is too high. In this case, use the hot water dispensing function as described above.
- After use, clean the nozzle and attachment according to the instructions in the Cleaning and Maintenance chapter.

Automatic Shut-off of the Coffee Machine

The coffee machine will automatically turn off after about 25 minutes of inactivity.

CLEANING AND MAINTENANCE

Before cleaning, unplug the power cord from the mains socket and allow the appliance to cool down.

Do not use abrasive cleaning agents, solvents, or any substances to clean any parts of the appliance that could damage the surface of the appliance. None of the components of this appliance are dishwasher safe.



Warning:

To prevent the risk of electric shock, do not submerge the appliance, plug or power cord in water or any other liquid.

Baskets, Portafilter and Brew Head

The basket and portafilter should be cleaned properly after each use.

1. Remove the portafilter with the used coffee from the brew head. Dispose of the coffee grounds in the compost heap or in regular municipal waste. If the coffee grounds are difficult to remove from the basket, use a table knife or spoon.
2. Remove the basket from the portafilter using the button on the portafilter.



Warning:

Take extra care as the coffee grounds, basket and portafilter are very hot after use. There is a risk of burns.

3. Rinse the basket and portafilter under warm running water and wipe them dry with a clean cloth. Place them on the heating surface so that they are preheated and ready for use.
4. Remove ground coffee remains from the brew head using a damp cloth.

Drip Tray

- The drip tray should be emptied and washed after each use of the appliance.
- First remove the grid from the drip tray and then remove the water. Wash the tray and grid in warm water with the addition of neutral dishwashing detergent. Then rinse both parts under running water, wipe dry and return to their place.

Steam Nozzle and Steam Nozzle Attachment

- It is necessary to clean the nozzle and the attachment thoroughly after every use.
- Take off the attachment, rinse under running water and wipe dry.
- Clean the nozzle thoroughly using a damp cloth. If there is dried milk residue on the nozzle, immerse it in a container of hot water for a few minutes to soak it off. If the dried milk residue has blocked the steam spout hole, clean it with a needle. Finally, clean the nozzle with damp cloth, wipe dry and put the attachment on it.

Outer Case

Wipe the outer surface of the appliance using a lightly damp cloth and wipe dry.

DESCALING

Mineral deposits from water can accumulate in the internal circuit of the coffee machine with regular use. It is a natural process. Therefore, regular descaling is necessary. Mineral deposits can adversely affect the taste of the coffee being brewed.

1. Turn off the coffee machine and disconnect the power cord from the power socket.
2. Allow the coffee machine to cool down completely.
3. Remove the water tank and drip tray. Empty them.
4. Fill the water tank with a solution of water and descaling agent. Use a descaling agent suitable for espresso-type machines and follow the instructions given in the descaling agent's accompanying documentation.
5. Insert the water tank and drip tray into the coffee machine.
6. Place a bowl under the brewing head.
7. Insert the power plug into a power socket.

8. Switch on the coffee machine and allow it to preheat.
9. Press the ☑ button and let the heated solution flow through the head. Repeat the process until about half of the solution in the water tank has flowed through.
10. Then point the steam nozzle into the container and slowly turn the steam / hot water dispenser control until water starts to flow. Allow the water to drain until the water tank is empty.
11. If the bowl is full, interrupt the descaling process and pour out the water. Place the empty bowl again under the head and continue descaling.
12. When the water tank is empty, remove it and rinse with clean water.
13. Pour clean water into the water tank and insert it back into the coffee machine.
14. Now repeat the whole process again with clean water. This removes limescale and descaling agent residue.



Warning:

Always be careful when handling the bowl. The descaling solution is heated to a high temperature and there is a risk of scalding if not handled correctly.

Storage

- If you will not be using the appliance for an extended period of time, unplug the plug from the mains socket, allow the appliance to cool down and clean it according to the instructions in the chapter "Cleaning and Maintenance".
- Before storing, ensure that the appliance and all accessories are thoroughly clean and dry.
- Store the appliance in a dry, clean, and well-ventilated place away from extreme temperatures and out of the reach of children or pets.

TROUBLESHOOTING

Problem	Cause	Solution
Coffee machine cannot be turned on.	The power cord plug is incorrectly inserted in the power socket.	Connect the power plug to the power socket properly.
Water is leaking out the bottom of the coffee machine.	The drip tray is full.	Carefully remove the tray and empty it.
	The coffee machine is not working properly.	Contact an authorised service centre.
The water is coming out of the portafilter.	Removing the water tank from the machine may cause a small amount of water to drip.	This is a normal occurrence. There was a leak from the water outlet when removing the water tank.
	The remains of the ground coffee remained on the edge of the portafilter.	Before inserting the portafilter into the brew head, wipe the edge of the portafilter to remove any ground coffee residue.
	The portafilter is not installed correctly in the brew head.	Remove the portafilter and reinsert it into the brew head.
The brewed coffee smells of acid (vinegar).	The frothing of the milk has just ended or steam is being generated or the steam button is not reset due to excessive temperature.	Allow the coffee machine to cool down.
	You have not rinsed with clean water after descaling.	Perform the descaling correctly.

Problem	Cause	Solution
	The ground coffee is stored in a warm and humid environment for a long time and has spoiled.	Store ground coffee in a dry and cool place as recommended by the manufacturer. Ideally, use freshly ground coffee.
There is no steam.	The steam button light has not yet come on and therefore no steam can be formed.	Wait for the steam button light to turn green.
	The milk frothing container is too large or does not have a suitable shape.	Use a higher container with straight walls.
	You're using skim milk.	To achieve froth, it is necessary to use semi-skimmed or whole milk.
	The steam nozzle is dirty or blocked.	Clean the nozzle.
The metal parts of the tank are rusted.	You have used the wrong descaling agent or have not followed the instructions of the manufacturer.	Use a descaling agent suitable for espresso-type machines and follow the instructions given in the descaling agent's accompanying documentation.



Note:

If the problem is not listed in the table or if the problem persists, turn off the coffee machine, disconnect it from the power source, and contact an authorised service centre.

TECHNICAL SPECIFICATIONS

Rated voltage range220–240 V-
 Rated frequency..... 50–60 Hz
 Rated power input..... 1050 W
 Noise level.....75 dB(A)

The declared noise emission level of the appliance is 75 dB(A), which represents a level A of acoustic power with respect to a reference acoustic power of 1 pW.

We reserve the right to change the text and technical specifications.

INSTRUCTIONS AND INFORMATION ON DISPOSING OF USED PACKAGING MATERIALS

Dispose of used packaging material at a site designated for waste in your municipality.

DISPOSING OF USED ELECTRICAL AND ELECTRONIC EQUIPMENT



This symbol on the products or accompanying documents indicates that used electrical and electronic products should not be disposed of with regular municipal waste. For proper disposal and recycling, take these products to designated collection points. Or in some European Union states or other European countries the products can be returned to the local retailer when buying an equivalent new product. Disposing of this product correctly helps save valuable natural resources and prevents damage to the environment by improper waste disposal. Ask your local authorities or collection facility for more details. In accordance with national regulations penalties may be imposed for the incorrect disposal of this type of waste.

For business entities in European Union states

If you want to dispose of electric or electronic devices, ask your retailer or supplier for the necessary information.

Disposal in other countries outside the European Union

This symbol is valid in the European Union. If you wish to dispose of this product, request the necessary information about the correct disposal method from the local council or from your retailer.



This product complies with all the essential requirements of the EU directives that apply to it.

