



3x1 HDMI 2.0 Switch with IR & Voice APP Control

User Manual





Safety and Notice

The device has been tested for conformance to safety regulations and requirements, and has been certified for international use. However, like all electronic equipment, the device should be used with care. Please read and follow the safety instructions to protect yourself from possible injury and to minimize the risk of damage to the unit.

- Follow all instructions and warnings marked on this unit.
- Do not attempt to service this unit yourself, except where explained in this manual.
- Provide proper ventilation and air circulation and do not use near water.
- Keep objects that might damage the device and assure that the placement of this unit is on a stable surface.
- Use only the power adapter and power cords and connection cables designed for this unit.
- Do not use liquid or aerosol cleaners to clean this unit.
- Always unplug the power to the device before cleaning.



Features

- Support panel, remote control, APP, Alexa switching
- Support 2.4G wireless for APP & Alexa control
- Support app control switching via the Magic Home app
- Support voice control switching via Alexa to control the switcher
- Support high definition resolution 4K@60Hz and full 3D
- Support 600MHz per channel bandwidth (18Gbps all channels)
- Support 12bit per channel (36bit all channels) deep color
- Support HDCP 2.2
- Support High Dynamic Range (HDR) and Dolby Vision
- Support LPCM, DTS, Dolby Digital 5.1 & 7.1 audio
- Support CEC Consumer Electronics Control
- Support Smart Switching when new source in, source removed and memory function.

Package contents

- 3x1 HDMI 2.0 Switch
- Power adapter DC 5V/1A
- IR Remote control
- User Manual

Layout

IR

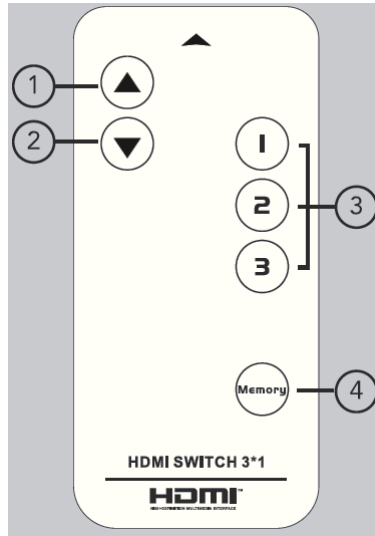

1. Pressing to select the previous source
2. Pressing to select the next source
3. 1/2/3: Pressing the number to select the input source accordingly
4. MEMORY: Pressing "MEMORY" to get the switch remember the active input source, and select this input source port automatically when restarts.

Rear Panel

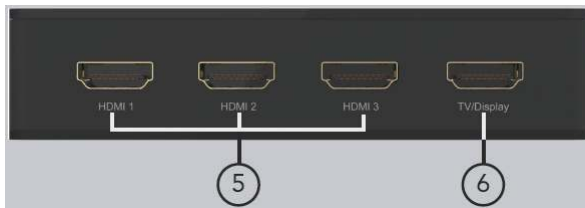

5. Input1-3: HDMI Input 1-3 Port
6. TV/Display: HDMI Output Port

Side



7. Power: DC 5V/1A

Front Panel

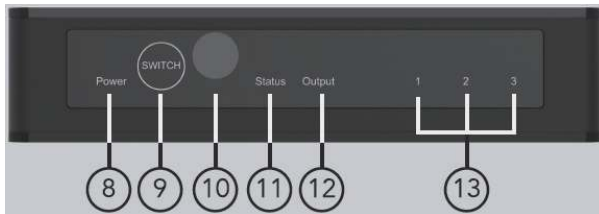

8. Power LED Indicator
9. SWITCH: Short press to change the input channel and long press to reset the Wi-Fi module
10. IR Signal Receiver Port
11. Status: Wi-Fi Module Status LED Indicators
 No matching: Flicker Quickly
 Get matching: Flicker Slowly
 Get matched: No LED Light
12. Output Port LED Indicators
13. 1/2/3: Input Port 1/2/3 LED Indicators
 Red LED indicates "Signal Not Selected".
 Blue LED indicates "Active Signal Path".
 No LED indicates "No Input Signal".

App Control

1. Download the “Magic Home” App from the Google Play or Apple Store firstly and install it



QR code for Android Download



QR code for IOS Download

2. Open the Magic Home app, sign up an account with your mobile phone or email, and then to sign in to the app, the login area is selecting United States.

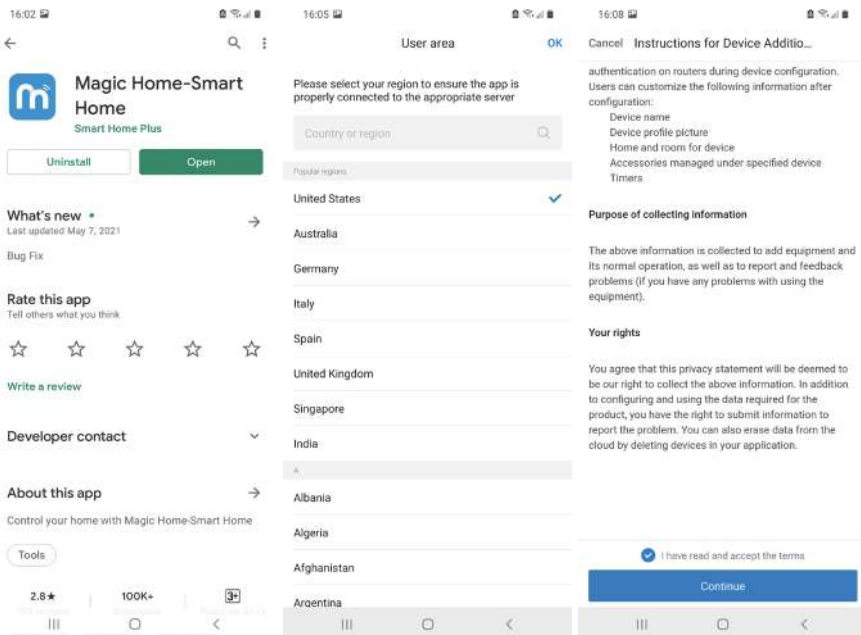

3. After entering app, click home icon in the lower left corner of UI, and select “Add device” then select universal remote device.

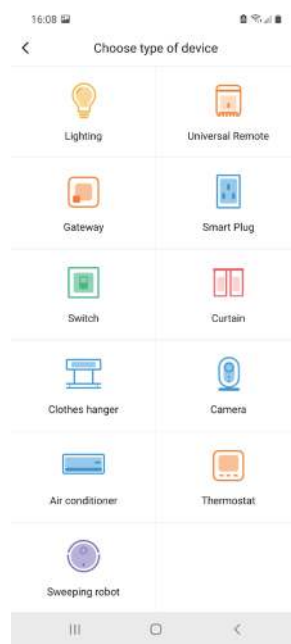
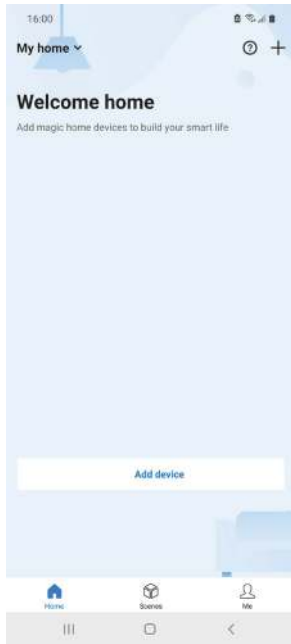

4. Long press the smart switcher select button for 10s to reset the Wi-Fi module till the states LED light starts to flicker quickly.
5. When the states LED flicker quickly, click the operation confirmed option and then click NEXT.
6. Select the Wi-Fi you want to connect to (only 2.4 GHz band Wi-Fi is supported), don't recommend the guest mode Wi-Fi to avoid the matching issue with the smart switcher and the phone or other devices via the app, and then enter your password and click Next.

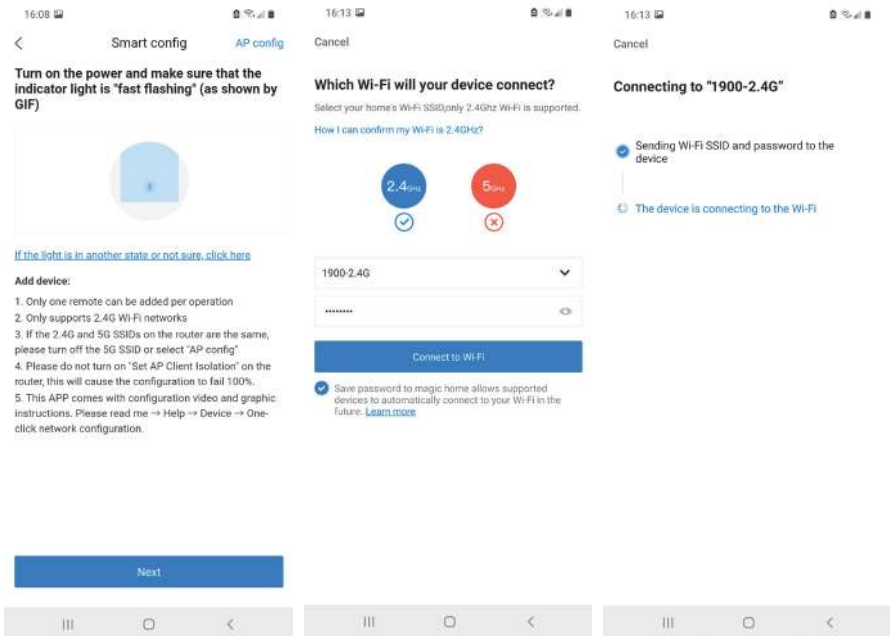

- When matching, a matching progress 0 to 100% will be displayed on the mobile phone's app. When matching is connected, the LED status light will flicker quickly to slow flicker and finally not flicker. When matching is completed, you can click smart switcher icon from the HOME page and enter the smart switcher control UI. You can control the smart switcher via the app UI at any places which can connect to Ethernet normally.

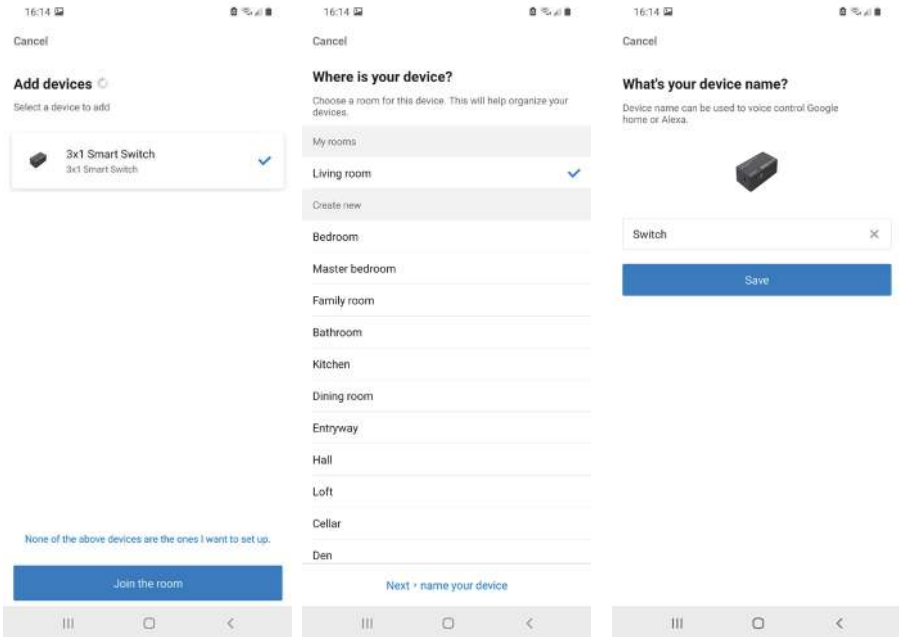

Note: Please keep the smart switcher and phone which used to match and control the smart switcher as closer as possible to the router to keep the wireless signal.

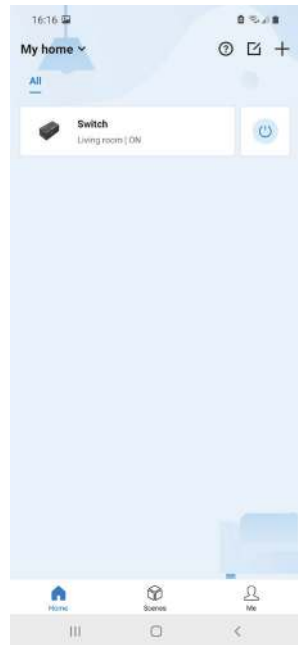
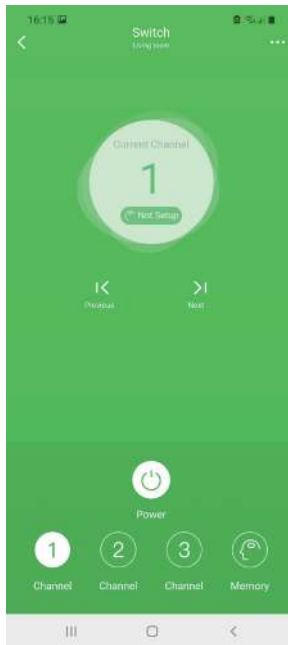
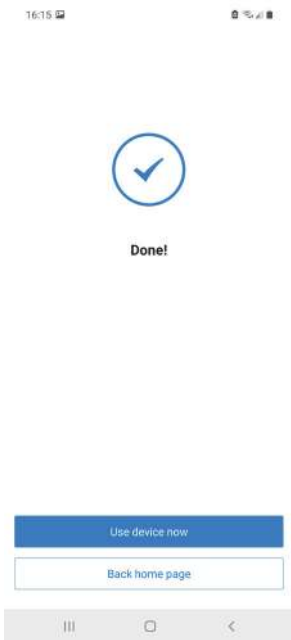

Amazon Alexa Setting

1. Active the Skills to link the “Magic Home” app
2. At the Amazon Alexa page, you need to select “Skills” option and input “Magic Home Lite” and click “search” button to enter the next step.

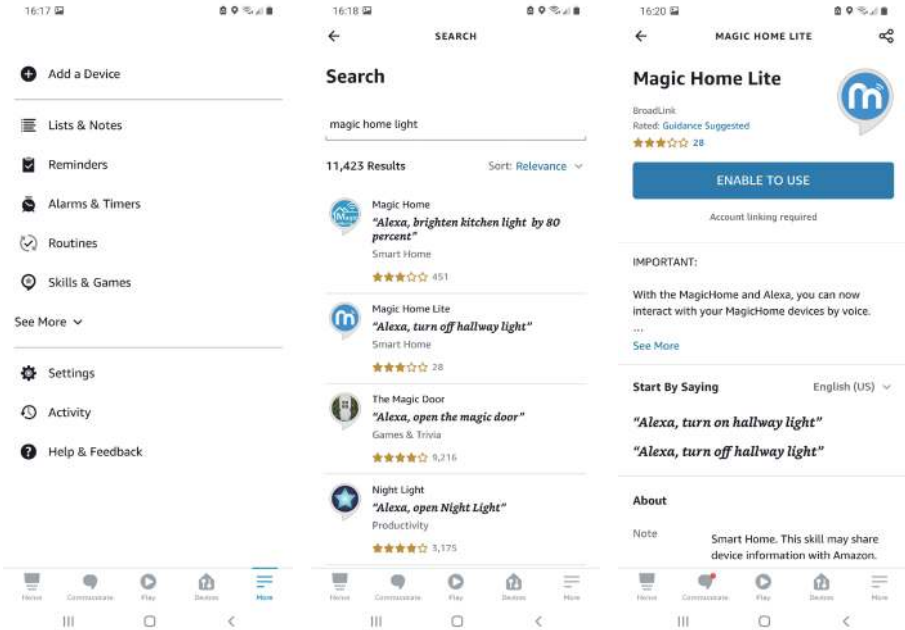

3. Confirm the two steps are finished and click the next icon.
4. Choose the American region as default, regardless of which country the customer actually uses

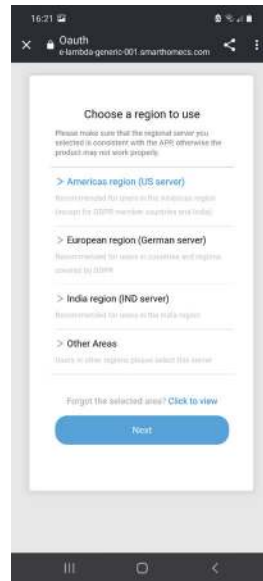
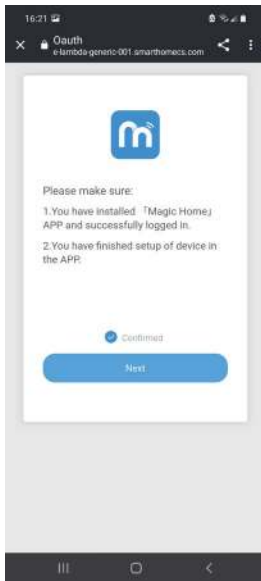

5. As registered the account with Email address or phone number and Password at the front and fill in it at this page.
6. At this step, the magic home lite has been successfully linked. You can use voice control the switcher to change input source via Alexa.

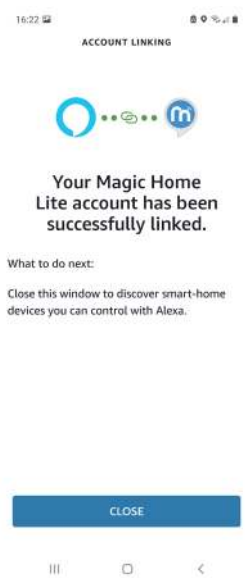
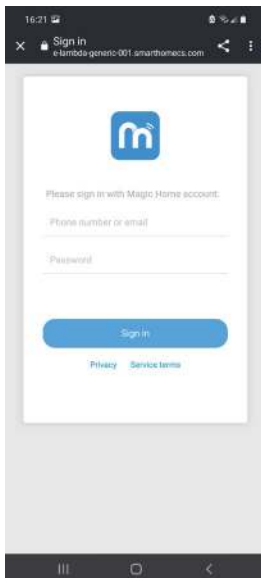

Alexa voice command list

Function	Voice command
Turn on function	Alexa, Turn the *****(For example: smart switcher) Alexa, Turn on the **** Alexa, Switch on the ****
Turn off function	Alexa, Off the ****(For example: smart switcher) Alexa, Turn off the **** Alexa, Switch off the **** Alexa, Shut down the **** Alexa, Shut the ****
switch to input channel	Alexa, Change the **** to HDMI N(N=1,2,3) Alexa, Jump the **** to HDMI N Alexa, Switch the **** to HDMI N Alexa, Change the **** input to HDMI N Alexa, Jump the **** input to HDMI N Alexa, Switch the **** input to HDMI N

**** is the name that you type in when setting Magic Home app

Troubleshooting

Problems	Causes	Solutions
Power light is off and product is not working	Is the power adapter properly connected	Please check if the power adapter is connected properly
Screen splash	HDMI cable may not be HDMI 2.0 specification or the cable is too long	Please use the standard HDMI 2.0 cable, the input/output cable length does not exceed 5M 4K/60Hz 4:4:4, 4K@30Hz/1080p can reach 10M to 10M
Can't match the smart switcher and the phone or other devices via app	Maybe the smart switcher and the phone is not closer as recommended with the router when matching	Please keep the smart switcher and phone which used to match and control the smart switcher as closer as possible to the router. And we don't recommend to use the guest mode Wi-Fi to matching
Can not control the smart switch via app via phone or voice via Alexa	Maybe the matching between the smart switcher and the phone has not finish yet, and the skill of the Alexa doesn't enable the app to activate yet.	Please matching the smart switcher and the phone follow the steps as "To match the Smart Switcher with the phone with app" and enable the app skill of the Alexa follow the steps as "To activate Skills"

Blank page

Thank You
for your purchase!

Support

For more info or tech support
<http://www.siig.com/support>

Aug, 2021 Copyright © 2021 by SIIG, Inc. All rights reserved.