

Dear customer, thank you for purchasing our product. Please read the following instructions carefully and follow them to ensure safe and satisfactory use. Avoid improper handling of this device and always follow the principles of using electrical appliances. Keep the user manual in a safe place. Intended for indoor use. Do not expose the receiver to high humidity, and avoid contact with liquids and aggressive substances. Clean only when disconnected from the mains, do not use abrasive cleaners.

The device is used to alert you to movement in the monitored area. The receiver (gong) and transmitter (magnetic sensor) operate on a radio frequency of  $433.92 \pm 1$  MHz. The bell is designed for permanent connection to a 230 V~ mains supply, and the magnetic sensor is designed for use on doors or windows that open. The signal range is max. 180 m in open space without interference. The set has a so-called function pairing (Learning code) – the sensor is able to generate its own pairing code, which the chime receives and stores in its memory. The set can thus be expanded with additional transmitters or receivers. The pairing function also prevents the set from interfering with neighbouring doorbells and devices operating on a similar frequency. The WiFi connection and Tuya app allow you to receive information about people's movements on your phone and remotely manage the chime settings.

**Receiver description:**

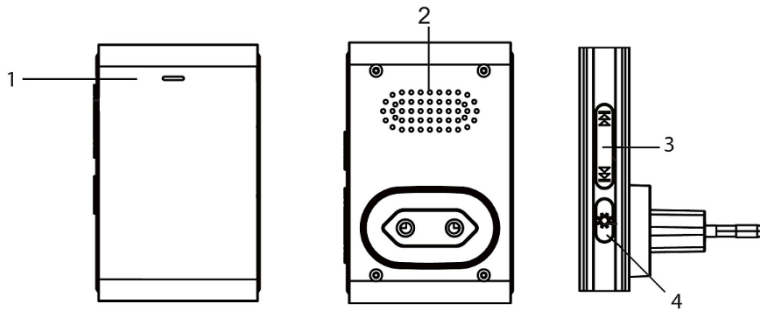

- 1. LED indicator
- 2. Speaker
- 3. Changing the ringtone
- 4. Change volume / Pairing

**Transmitter description:**

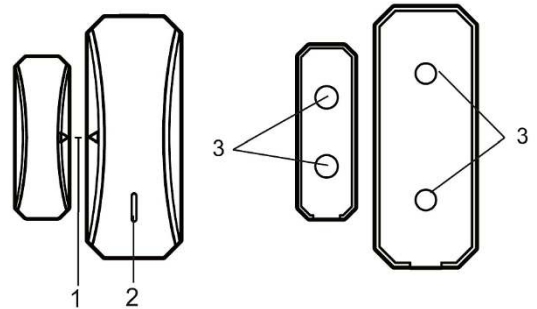

- 1. Magnetic surfaces with centre arrows
- 2. LED indicator
- 3. Preparation for mounting holes

**Specifications**

Signal range	180 m in open space
Transmission frequency	433.92 MHz
Ringing volume	5 levels 0 - 25 - 50 - 75 - 100 dB(A)
Number of melodies	64
Gong power supply	AC 230V / 50Hz
Bell consumption in standby mode	<0.4W
Sensor power supply	1 x 3V (CR2032) battery
Sensor waterproof protection	IP44
Operating temperature of doorbell	-10 °C to +45 °C
Sensor operating temperature	-20 °C to +40 °C

**Pairing the sensor with the chime**

1. Plug the receiver into a 230 V AC/50 Hz socket.
2. Press and hold the pairing button on the chime for approx. 5 seconds.
3. Release the button when the indicator light on the chime lights up.
4. The chime will switch to pairing mode, which lasts 25 seconds. During this time, disconnect the magnetic sensor from the other part. When the melody sounds, the sensor is paired (pairing mode is then turned off).

To pair multiple buttons, repeat steps 1, 2, and 3 for each sensor. Up to 6 sensors can be paired with one gong. Up to 15 gongs can be paired with one sensor.

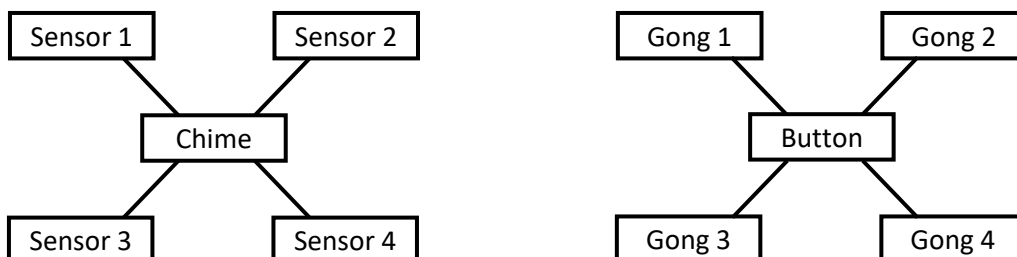



**Note:** The gong has an internal memory that stores the codes of currently paired sensors in case of a power failure. Therefore, it is not

necessary to pair them again after a power failure. The receiver is intended for indoor use only.

### Deleting paired sensors from memory

1. Press and hold the pairing button on the chime.
2. Plug the chime into an electrical outlet. A melody will sound; continue to hold the button.
3. Release the button after 5 seconds. The LED will flash briefly and then go out.
4. Once the LED stops flashing, the memory is deleted.

### Selecting the ringtone and volume

1. Use the buttons "  " or "  " on the chime to select the ringtone melody.
2. Press the volume control button  repeatedly to select one of five levels: 0 - 25 - 50 - 75 - 100 dB(A).

### Sensor placement

1. Start by pairing the sensor with the chime.
2. Before installation, test the range and reliability of the device in the selected location. The sensor is weather-resistant.
3. Install both parts of the sensor opposite each other; the marked arrows indicate the centres of the magnets. Attach the bottom covers of both parts to the base using double-sided adhesive tape or screws. Leave a minimum gap between them so that they do not rub against each other. Use the marked locations for screwing. Remove the bottom covers before installation and drill through the two marked locations on each of them.

**Note:** Metallic materials such as steel posts or doors with metal frames reduce the signal range. Always test the reliability of the connection first. If you encounter problems, look for another or closer location for the receiver (gong).

### Troubleshooting:

If the receiver does not ring repeatedly, check:

- whether the distance between the transmitter and receiver is too great
- whether there are strong sources of signal interference between the transmitter and receiver (radio and wireless networks, large metal objects, reinforced concrete walls, etc.)
- if the problem persists, contact your dealer.

### Opening the transmitter and replacing the battery

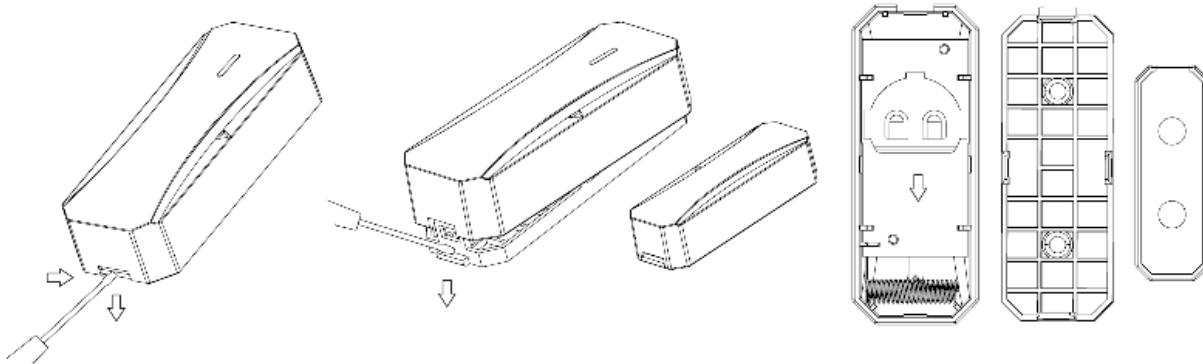

1. Insert a flat screwdriver into the gap on the sensor cover and carefully turn it.
2. Lift off the cover and remove the battery.
3. Insert a new battery, ensuring correct polarity.
4. Close the button cover and snap it firmly into place.
5. The same applies to opening both parts of the sensor in the case of screw mounting.



## TUYA mobile app

**STEP 1** Search for and install the Tuya app on Google Play or the App Store (depending on your phone's operating system).

**STEP 2** Register a new account using your email or phone number and log in to the app.

**STEP 3** To switch the device to pairing mode, press and hold the  button for about 5 seconds. The device will beep and start flashing - it is now in pairing mode. (If the device does not switch to pairing mode, press and hold the  button (about 5 seconds) to reset the device.)

**STEP 4** In the mobile app, click on the + in the upper right corner and then on "Add device" (see Fig. 1). The app will start searching for devices. Once the app finds the device, it will display it under the name "Solight Smart WiFi gong" (Fig. 3). Click on it or wait for it to be added automatically.

**Note:** If the device cannot be found automatically, go to the "Add manually" section, select Other products (WiFi), and follow the instructions in the application.

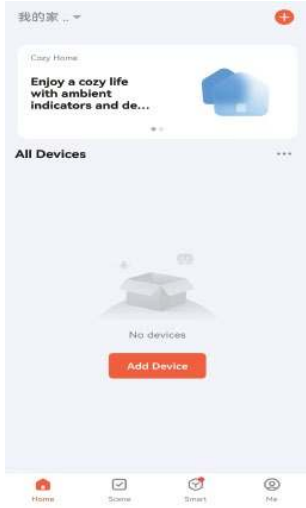

Fig. 1

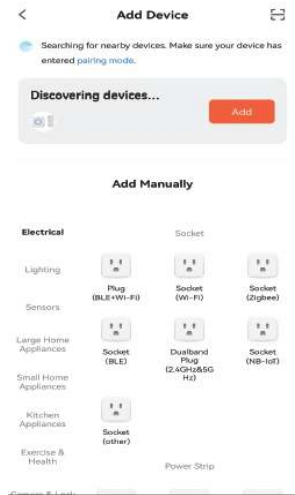

Fig. 2

Enter your Wi-Fi network login details, see Fig. 3. The device will now start connecting, see Fig. 4. Once complete, press Done, see Fig. 5.



Fig. 3

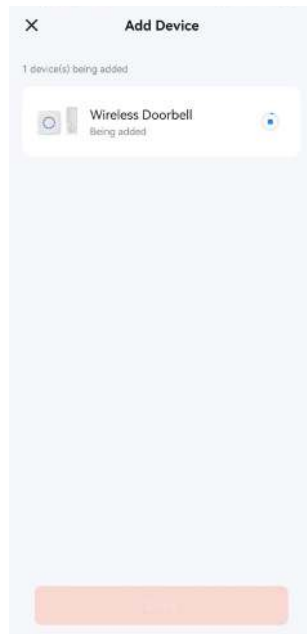

Fig. 4

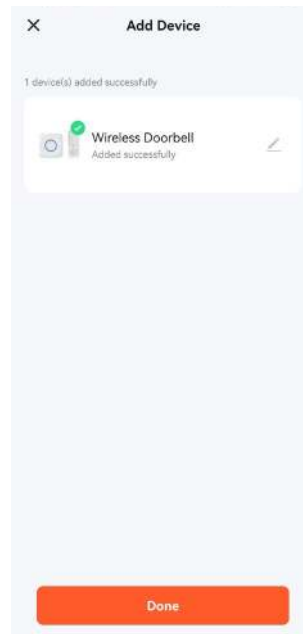





Fig. 5

## Controlling the device using a mobile application



Fig. 6

-  Adding a button
-  Viewing records
-  Settings

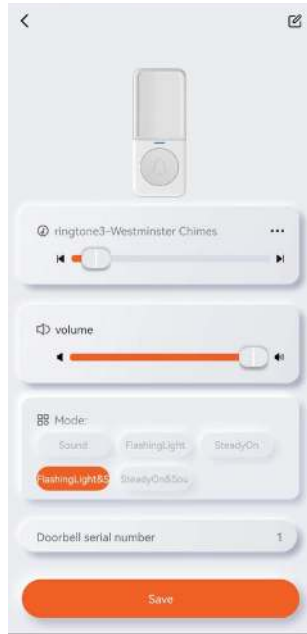

Fig. 7



-  Renaming a button
-  Selecting melodies:  
A different melody can be set for each button. After setting, click Save.



Fig. 8

To remove a button, move the button name to the left. Click Delete to delete it.

The product has been issued with a CE Declaration of Conformity in accordance with applicable regulations. Available on the website or upon request from the manufacturer: [info@solight.cz](mailto:info@solight.cz)

Solight Holding s.r.o. declares that the product complies with the requirements and provisions of Directive 2014/53/EU. The device can be freely operated in the EU.

The product can be operated on the basis of general authorisation No. VO-R/10/05.2014-3.



# SOLIGHT

Solight Holding, s.r.o., Na Brně 1972, Hradec Králové 500 06, Czech Republic.