

## Height-Adjustable Mobile TV Cart with Crank Handle



### User Manual

SKU#: 1110C-MOBILE-TV-CART

---

# Compliance Statements

## **Use of Trademarks, Registered Trademarks, and other Protected Names and Symbols**

This manual may make reference to trademarks, registered trademarks, and other protected names and/or symbols of third-party companies not related in any way to StarTech.com. Where they occur these references are for illustrative purposes only and do not represent an endorsement of a product or service by StarTech.com, or an endorsement of the product(s) to which this manual applies by the third-party company in question. Regardless of any direct acknowledgement elsewhere in the body of this document, StarTech.com hereby acknowledges that all trademarks, registered trademarks, service marks, and other protected names and/or symbols contained in this manual and related documents are the property of their respective holders.

PHILLIPS® is a registered trademark of Phillips Screw Company in the United States or other countries.

# Safety Statements

## Safety measures

- Product installation and/or mounting should be completed by a certified professional as per the local safety and building code guidelines.

## Mesures de sécurité

- L'installation et/ou le montage du produit doit être réalisé par un professionnel certifié et dans le respect des normes locales et du code de construction local.

## Säkerhetsåtgärder

- Installation och/eller montering får endast göras av behöriga yrkespersoner och enligt gällande lokala förordningar för säkerhet och byggnormer.

## Veiligheidsmaatregelen

- De installatie en/of montage van het product moet worden uitgevoerd door een erkend vakman volgens de plaatselijke veiligheids- en bouwvoorschriften.

## 安全対策

- 製品の設置やマウントは、使用地域の安全ガイドラインおよび建築基準に従い、有資格の専門業者が行うようにしてください。

## Misure di sicurezza

- L'installazione e/o il montaggio dei prodotti devono essere eseguiti da un tecnico professionale certificato che conosca le linee guida locali sulle norme edilizie e sulla sicurezza.

## Medidas de seguridad

- La instalación y/o montaje del producto debe ser realizada por un profesional certificado de acuerdo con las directrices de los códigos locales de seguridad y construcción.

## Sicherheitsmaßnahmen

- Die Installation und/oder Montage des Produkts sollte von einem zertifizierten Fachmann gemäß den örtlichen Sicherheits- und Bauvorschriften durchgeführt werden.

## Warning Statements

- StarTech.com Ltd. is not responsible for any property damage and/or personal injury resulting from the installation procedures outlined in this technical document.
- Assemble this product according to the instructions. Read the entire manual and ensure the instructions are fully understood before assembling and/or using this product.
- Do not exceed the weight capacity of this product. Overloading this product might result in personal injury or property damage.
- Weight capacity of the TV mount: 220 lbs (100 kg)  
Weight capacity of the camera shelf: 11 lbs (5 kg)  
Weight capacity of multimedia shelf: 11 lbs (5 kg)
- Do not allow children to climb on this product or to use this product without proper supervision.
- This product is intended for indoor use only and should not be used outdoors.
- Do not over-tighten the screws. If any resistance is encountered, stop tightening.
- Assembling this product is a two-person task. Do not attempt to assemble this product and install equipment without assistance.
- Before adding equipment to this product, ensure the product has been properly assembled, and that the product can support the weight of the added equipment.
- Make sure all of the equipment has been properly secured before adjusting this product.
- **Stored Energy Hazard!** This product contains a spring mechanism which can cause the assembly and/or mounted equipment to move forcibly, and quickly, upwards. Always exercise caution when handling, or in close proximity to, the spring arm(s). Do not remove the mounted equipment unless the spring arm is moved to the highest position or (if possible) the spring force is adequately lowered to remove any danger posed. Failure to do so may result in property damage and/or serious personal injury.
- **Pinch hazards!** Keep hands away from any pinch points created by the mechanical components when lowering or raising the display. Failure to do so may result in serious personal injury.

## Avertissements

- StarTech.com Ltd. n'est pas responsable des dommages matériels et/ou corporels résultant des procédures d'installation décrites dans ce document

technique.

- Assemblez ce produit conformément aux instructions. Lisez l'intégralité du manuel et assurez-vous que les instructions sont bien comprises avant d'assembler et/ou d'utiliser ce produit.
- Ne dépassez pas la capacité de poids de ce produit. La surcharge de ce produit peut entraîner des blessures ou des dommages matériels.
- Capacité de poids du support d'écran: 100 kg  
Capacité de poids de l'étagère pour caméra : 5 kg  
Capacité de poids de l'étagère multimédia : 5 kg
- Ne laissez pas les enfants grimper sur ce produit ou l'utiliser sans surveillance adéquate.
- Ce produit est destiné à être utilisé à l'intérieur uniquement et ne doit pas être utilisé à l'extérieur.
- Ne serrez pas trop les vis lors de l'assemblage de ce produit. Si vous rencontrez une résistance lors du serrage des vis, cessez de serrer.
- L'assemblage de ce produit nécessite deux personnes. Ne tentez pas d'assembler le produit et d'installer les équipements sans aide.
- Avant d'ajouter des équipements au produit, vérifiez que vous l'avez correctement assemblé et installé, et que le produit peut supporter le poids des équipements que vous y ajoutez.
- Assurez-vous que tout l'équipement a été correctement fixé avant de régler ce produit.
- Danger lié à l'énergie stockée ! Ce produit contient un mécanisme à ressort qui peut provoquer un déplacement forcé et rapide de l'ensemble et/ou de l'équipement monté vers le haut. Faites toujours preuve de prudence lorsque vous manipulez le(s) bras à ressort ou que vous vous trouvez à proximité de celui-ci. Ne retirez pas l'équipement monté tant que le bras à ressort n'a pas été placé dans la position la plus haute ou (si possible) que la force du ressort n'a pas été suffisamment réduite pour éliminer tout danger. Le non-respect de cette consigne peut entraîner des dommages matériels et/ou des blessures corporelles graves.
- Risques de pincement ! Gardez les mains à l'écart de tout point de pincement créé par les composants mécaniques lorsque vous abaissez ou relevez l'écran. Le non-respect de cette consigne peut entraîner des blessures corporelles graves.

## Varningsmeddelanden

- Se till att du monterar produkten i enlighet med instruktionerna.
- Läs hela manualen och se till att du förstår instruktionerna innan du börjar

- montera och använda produkten.
- Överskrid inte produktens viktkapacitet. Överbelastning av produkten kan orsaka skada på person eller egendom.
  - Viktkapacitet fäste för TV: 100 kg  
Viktkapacitet kamera hylla: 5 kg  
Viktkapacitet multimedia hylla: 5 kg
  - Låt inte barn klättra på produkten eller använda produkten utan uppsikt.
  - Produkten är endast avsedd för användning inomhus och ska inte användas utomhus.
  - Dra inte åt skruvarna för hårt när du monterar produkten. Om du måste ta i när du skruvar åt kan du sluta skruva åt.
  - Det krävs två personer för att montera produkten. Försök inte montera produkten och installera utrustning utan hjälp.
  - Innan du lägger till utrustning på produkten, se till att produkten är korrekt monterad, installerad och att produkten klarar av vikten på utrustningen som du lägger till.
  - Se till att all utrustning är korrekt installerad innan du börjar justera produkten.
  - Flytta inte vagnen över kablar eller ojämna ytor.
  - Innan du börjar flytta på vagnen, se till att hjulen är upplåsta.
  - Tippningsrisk! Denna produkt är fristående och kan därför tippas om den hanteras felaktigt eller överbelastas. Var försiktig när du flyttar, lastar, lossar och justerar produkten. Underlåtenhet att göra det kan leda till skador på utrustningen och / eller personskada.

## Waarschuwingen

- Zorg dat u dit product volgens de instructies in elkaar zet.
- Lees de gehele handleiding en zorg dat u de instructies begrijpt voordat u dit product in elkaar zet en gebruikt.
- Overschrijd de maximale capaciteit van dit product niet. Overbelasting van dit product kan letsel of materiële schade veroorzaken.
- Gewichtscapaciteit van de schermbevestiging (voor televisie): 50 kg  
Gewichtscapaciteit van het bovenste oppervlak (voor camera): 5 kg  
Gewichtscapaciteit van het multimedia oppervlak: 5 kg
- Geef kinderen geen toestemming om op dit apparaat te klimmen of dit product zonder goed toezicht te gebruiken.
- Dit product is alleen bedoeld voor binnengebruik en mag niet buiten worden gebruikt.
- Draai de schroeven niet te strak vast wanneer u dit product in elkaar zet. Als u

- weerstand voelt tijdens het vastdraaien van de schroeven, stop dan.
- Dit product moet met twee personen in elkaar worden gezet. Probeer dit product niet zonder hulp in elkaar te zetten en apparatuur te installeren.
  - Voordat u apparatuur aan dit product toevoegt, moet u ervoor zorgen dat u het op de juiste manier in elkaar hebt gezet en geïnstalleerd, en dat het product het gewicht van de toe te voegen apparatuur kan ondersteunen.
  - Zorg dat u de apparatuur goed installeert voordat u met het aanpassen van dit product begint.
  - Rijd de wagen niet over snoeren, kabels of ongelijke oppervlakken.
  - Voordat u de wagen gaat verplaatsen, moet u de zwenkwielen ontgrendelen.
  - Kantelgevaar! Dit product is vrijstaand en kan daarom kantelen bij verkeerde behandeling of overbelasting. Wees voorzichtig bij het verplaatsen, laden, lossen en aanpassen van het product. Als u dit niet doet, kan dit leiden tot schade aan de apparatuur en / of persoonlijk letsel.

## 注意

- 必ず取扱説明書に従って本製品の組み立てを行って下さい。
- 最初に取扱説明書を最後まで読み、本製品の組み立て方をすべて理解してから組み立て作業を始めて下さい。
- 本製品で定められた最大積載重量を超えないようにして下さい。最大積載重量をオーバーした場合、怪我をする恐れや器物破損の恐れがあります。
- マルチメディア棚の総耐荷重:5kg
- カメラ棚の総耐荷重:5 kg
- TVマウンタの総耐荷重:100 kg
- 本製品に小さなお子様が乗って遊ばないようにして下さい。お子様が使用する際には、適切な監視を怠らないようにして下さい。
- 本製品は、室内での使用を想定しています。戸外では使用しないで下さい。
- 本製品を組み立てる際、ネジを締めすぎないようにして下さい。ネジを締めているうちに手応えを感じたら、締めるのを止めてください。
- 本製品は、二人がかりでの組み立てを想定しています。手助けなしに単独で組み立てと設置を行わないで下さい。
- 本製品に装置を積載する前に、組み立てと設置が適切に行われたか確認して下さい。また、積載する装置の重量に本製品が対応しているか確認して下さい。
- 転倒注意! モニタが一番高い位置にある状態でカートを動かさないで下さい。また、モニタを押してカートを動かすのはやめて下さい。
- コードやケーブルの上、または凹凸のある床面でカートを移動させないで下さい。
- チップの危険。この製品は自立型であるため、取り扱いを誤ったり、過負荷になったりすると転倒しやすくなります。製品を移動、ロード、アンロード、お

よび調整するときは注意してください。そうしないと、機器の損傷や人身事故につながる可能性があります。

## Dichiarazioni di avvertenza

- Assicurarsi di Assemblare il prodotto secondo le istruzioni.
- Leggere l'intero manuale e assicurarsi di aver compreso tutte le istruzioni prima di iniziare ad assemblare e a utilizzare questo prodotto.
- Non superare la capacità di carico del prodotto. Il sovraccarico del prodotto potrebbe causare danni o lesioni.
- Portata massima del support per TV: 100 kg  
Portata massima del ripiano per camera: 5 kg  
Portata massima del ripiano multimediale: 5 kg
- Non consentire ai bambini di arrampicarsi sul prodotto o di utilizzarlo senza un'adeguata supervisione.
- Il prodotto è destinato all'uso in ambienti interni. Se ne sconsiglia l'impiego in ambienti esterni.
- Durante l'assemblaggio del prodotto, non stringere troppo le viti. Se si incontra resistenza mentre si stringono le viti, interrompere l'operazione.
- L'assemblaggio di questo prodotto richiede la presenza di due persone. Non tentare di assemblare il prodotto e installare le apparecchiature senza assistenza.
- Prima di aggiungere altre apparecchiature al prodotto, assicurarsi di averlo assemblato e installato correttamente e che sia in grado di sostenere il peso dell'apparecchiatura in questione.
- Assicurarsi di aver installato correttamente tutte le apparecchiature prima di procedere alla regolazione del prodotto.
- Non far passare il carrello sopra corde, cavi o superfici irregolari.
- Prima di procedere allo spostamento del carrello, verificare di aver sbloccato le rotelle.
- Rischio di ribaltamento! Questo prodotto è indipendente e quindi incline a ribaltarsi se maneggiato in modo improprio o sovraccarico. Prestare attenzione durante lo spostamento, il caricamento, lo scaricamento e la regolazione del prodotto. In caso contrario, potrebbero verificarsi danni alle apparecchiature e / o lesioni personali.

## Mensagens de aviso

- Certifique-se de que monta este produto de acordo com as instruções.
- Leia todo o manual e certifique-se de que entende as instruções antes de começar a montar e a utilizar este produto.
- Não exceda a capacidade de peso deste produto. Sobrecarregar este produto

To view manuals, videos, drivers, downloads, technical drawings, and more visit [www.startech.com/support](http://www.startech.com/support)

- pode resultar em ferimentos ou danos de propriedade.
- Capacidade de carga de la bandeja multimídia: 5 kg
  - Capacidade de carga de la bandeja de câmara: 5 kg
  - Capacidade de carga de suporte para TV: 100 kg
  - Não deixar as crianças trepar neste produto ou utilizar este produto sem a devida supervisão.
  - Este produto destina-se apenas a uma utilização no interior e não deve ser utilizado no exterior.
  - Quando montar este produto, não aperte demasiado os parafusos. Se encontrar resistência enquanto aperta os parafusos, pare de apertar.
  - Montar este produto é uma tarefa para duas pessoas. Não tentar montar este produto e instalar o equipamento sem assistência.
  - Antes de adicionar o equipamento a este produto, certifique-se de que o montou e instalou devidamente e de que o produto pode suportar o peso do equipamento que está a adicionar ao mesmo.
  - Certifique-se de que instala devidamente todo o seu equipamento antes de começar a ajustar este produto.
  - Não mova o carro pelos fios, cabos ou superfícies irregulares.
  - Antes de começar a mover o carro, certifique-se de que desbloqueia os rodízios.
  - Derrubando o perigo! Este produto é independente e, portanto, sujeito a tombar se for manuseado incorretamente ou sobrecarregado. Tenha cuidado ao mover, carregar, descarregar e ajustar o produto. Não fazer isso pode resultar em danos ao equipamento e / ou ferimentos pessoais.

## Advertencias de uso

- Asegúrese de ensamblar este producto según las instrucciones.
- Lea todo el manual y asegúrese de haber comprendido bien las instrucciones antes de proceder con el ensamblaje y el uso de este producto.
- Asegúrese de no exceder la capacidad de peso de este producto. La sobrecarga de este producto puede causar lesiones personales o daños en la propiedad.
- Capacidad de carga del estante multimedia: 5 kg
- Capacidad de carga del estante de la cámara: 5 kg
- Capacidad de carga del soporte de TV: 100 kg
- No permita que los niños se suban a este producto o que lo utilicen sin la debida supervisión de un adulto.
- El uso de este producto es solo para interiores y no debe utilizarse en

- exteriores.
- Cuando ensamble este producto, no apriete los tornillos más de lo debido. Si al apretar los tornillos siente resistencia, no los apriete más.
  - Se requieren dos personas para el ensamblaje de este producto. No intente ensamblar este producto e instalar otros equipos sin la debida asistencia de otra persona.
  - Antes de instalar equipos en este producto, asegúrese de haberlo ensamblado correctamente, a fin de que pueda soportar el peso del equipo que vaya a instalar.
  - Asegúrese de que ha instalado todo el equipo correctamente antes de efectuar ajustes de este producto.
  - No desplace el carrito encima de cables o superficies desniveladas.
  - Antes de empezar a mover el carrito, asegúrese de haber desbloqueado las ruedas. Antes de empezar a mover el carrito, asegúrese de haber desbloqueado las ruedas.
  - ¡Peligro de vuelco! Este producto es independiente y, por lo tanto, propenso a volcarse si se manipula incorrectamente o se sobrecarga. Tenga cuidado al mover, cargar, descargar y ajustar el producto. El no hacerlo podría resultar en daños al equipo y / o lesiones personales.

## Warnhinweise

- Beachten Sie bei der Montage dieses Produkts die Montageanweisungen.
- Bevor Sie dieses Produkt montieren und verwenden, lesen Sie das gesamte Handbuch und vergewissern Sie sich, dass Sie die Anweisungen verstanden haben.
- Überschreiten Sie nicht die Tragkraft dieses Produkts. Ein Überladen dieses Produkts kann zu Verletzungen oder zur Beschädigung des Produkts führen.
- Gewichtskapazität des Multimedia Fachbodens: 5 kg
- Gewichtskapazität des Kamera Fachbodens: 5 kg
- Gewichtskapazität der TV Halterung: 100 kg
- Gestatten Sie Kindern nicht, auf das Produkt zu klettern oder das Produkt ohne Aufsicht zu benutzen.
- Dieses Produkt ist nur zum Gebrauch in Innenräumen vorgesehen und sollte nicht im Freien verwendet werden.
- Achten Sie bei der Montage des Produkts darauf, die Schrauben nicht zu fest anzuziehen. Sobald Sie beim Anziehen der Schrauben auf Widerstand stoßen, stellen Sie das Anziehen ein.
- Die Montage dieses Produkts ist auf die Ausführung von zwei Personen ausgelegt. Versuchen Sie nicht ohne Hilfe, dieses Produkt zu montieren und Geräte zu installieren.
- Bevor Sie Geräte zu diesem Produkt hinzufügen, vergewissern Sie sich, dass

# Table of Contents

<b>Compliance Statements</b> .....	<b>i</b>
<b>Safety Statements</b> .....	<b>ii</b>
<b>Warning Statements</b> .....	<b>iii</b>
<b>Product Diagram</b> .....	<b>1</b>
Front-Angled View .....	1
<b>Product Dimensions</b> .....	<b>2</b>
Front View .....	2
<b>Product Information</b> .....	<b>3</b>
Package Contents .....	3
<b>Requirements</b> .....	<b>6</b>
<b>Installation</b> .....	<b>7</b>
Attach the Legs and Casters.....	7
Attach the Left and Right Columns to the Base.....	8
Install the Mounting Plate and Crank Handle.....	10
Install the Upper and Lower Shelves.....	12
Attach the TV Mounting Brackets .....	14
Mount the TV to the Mounting Plate .....	16
Assemble the Camera Shelf.....	17
Attach the Camera Shelf to the Mounting Plate.....	18
<b>Operation</b> .....	<b>19</b>
Adjust the Tilt Angle of the TV.....	19
Move the Mobile TV Cart.....	19
Adjust the Height of the Upper Shelf .....	20
Adjust the Height of the TV Mount.....	21
Attach Adhesive Cable Management Clips .....	22
<b>Warranty</b> .....	<b>23</b>

# Product Diagram

## Front-Angled View

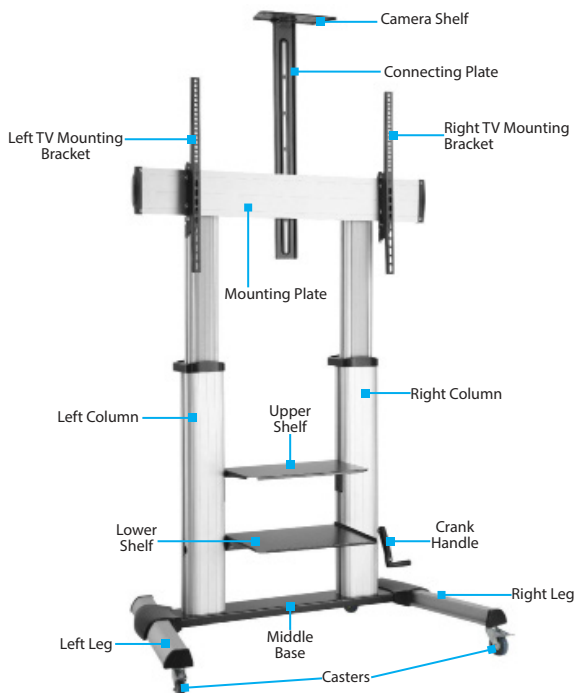

# Product Dimensions





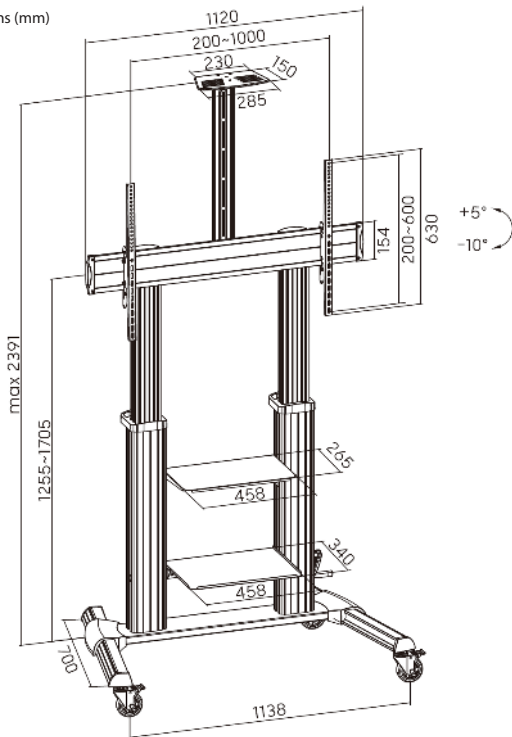







## Front View











Dimensions (mm)





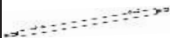







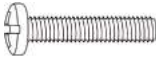
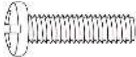

# Product Information

## Package Contents

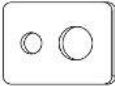
 <p>Middle Base Qty: 1</p>	 <p>Left Leg Qty: 1</p>	 <p>Right Leg Qty: 1</p>	 <p>Left Cover Qty: 1</p>
 <p>Right Cover Qty: 1</p>	 <p>Mounting Plate (F) Qty: 1</p>	 <p>Plastic Cover Qty: 2</p>	 <p>Plastic Handle Qty: 2</p>
 <p>Caster Qty: 4</p>	 <p>Left Column Qty: 1</p>	 <p>Right Column Qty: 1</p>	 <p>Crank Handle Qty: 1</p>

 <p>TV Mounting Bracket - Left Qty: 1</p>	 <p>TV Mounting Bracket - Right Qty: 1</p>	 <p>Top Cover Qty: 2</p>	 <p>Camera Shelf Qty: 1</p>
 <p>Upper Shelf Qty: 1</p>	 <p>Lower Shelf Qty: 1</p>	 <p>Connecting Plate Qty: 1</p>	 <p>Connecting Bar Qty: 1</p>
 <p>M5 x 40 mm Button Head Screws (U) Qty: 1</p>	 <p>M6 x 25 mm Hex Head Screws (V) Qty: 4</p>	 <p>M4 x 6 mm Screws (W) Qty: 3</p>	 <p>M4 x 6 mm Screws (X) Qty: 2</p>

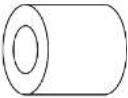
 <p>M6 x 14 mm Screws (Y)</p> <p>Qty: 4</p>	 <p>M8 x 25 mm Hex Head Screws (Z)</p> <p>Qty: 12</p>	 <p>M6 x 8 mm Screws (A1)</p> <p>Qty: 12</p>	 <p>5 mm Hex Key (B1)</p> <p>Qty: 1</p>
 <p>19 mm Wrench (C1)</p> <p>Qty: 1</p>	 <p>M5 x 14 mm Pan Head Screws (M-A)</p> <p>Qty: 4</p>	 <p>M6 x 14 mm Pan Head Screws (M-B)</p> <p>Qty: 4</p>	 <p>M6 x 30 mm Pan Head Screws (M-C)</p> <p>Qty: 4</p>
 <p>M8 x 30 mm Pan Head Screws (M-D)</p> <p>Qty: 4</p>	 <p>M8 x 50 mm Pan Head Screws (M-E)</p> <p>Qty: 4</p>	 <p>Square Washers (M-F)</p> <p>Qty: 4</p>	 <p>Small Spacers (M-G)</p> <p>Qty: 8</p>

 <p>Large Spacers (M-H) Qty: 8</p>	 <p>Adhesive Cable Management Clips Qty: 8</p>	 <p>User Manual Qty: 1</p>
--	---	---

## Requirements

For the latest requirements, please visit  
[www.startech.com/1110C-MOBILE-TV-CART](http://www.startech.com/1110C-MOBILE-TV-CART)

- Maximum TV display size of 100"
- Maximum TV weight of 220lb (110kg)
- (Optional) Web Camera x 1
- (Optional) Media Device x 1
- Compatible VESA mounting hole patterns: 200x200, 200x400, 300x300, 400x200, 400x300, 400x400, 600x400, 1000x600
- Phillips Head Screwdriver x 1

## Installation

### Attach the Legs and Casters

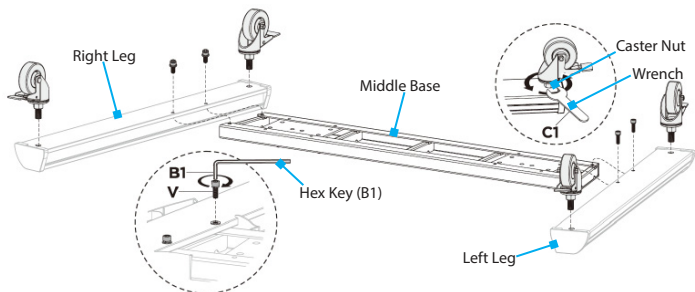

Figure 1

1. Flip the **Middle Base, Left Leg, and Right Leg** upside down and arrange as shown on a clean and flat surface. (Figure 1)

**Note:** Cover hard floors with a soft cloth to prevent scratching.

2. Slot the **Left and Right Legs** over the corner points on the **Middle Base** and secure in place with four **M6 x 25mm (V) screws** using the **Hex Key (B1)**.
3. Insert the **Casters** into the corner holes located on the bottom of the **Left and Right Legs** and tighten using the **Wrench (C1)**.
4. Flip the assembly upright so the **Casters** are making contact with the floor.
5. (For uneven surfaces) Flip the assembly upside down and use the **Wrench (C1)** to adjust the **Nut** located on each **Caster**.

## Attach Left and Right Columns to the Base

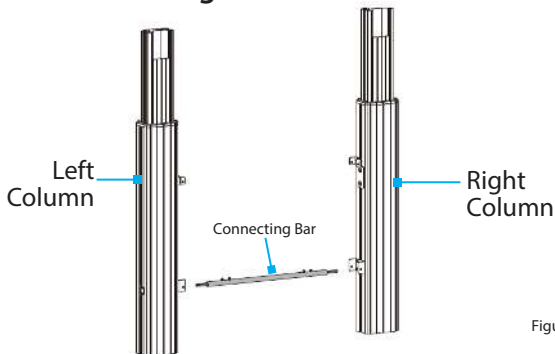
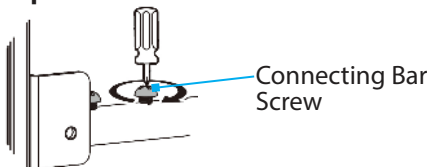

Figure 2

1. Position the **Left** and **Right Columns** as shown on a flat working surface. (Figure 2)
2. Insert one end of the **Connecting Bar** into the bottom bracket hole of the **Right Column**.



3. Repeat Step 2 on the **Left Column** with the opposite end of the **Connecting Bar**. Gently tighten the **Connecting Bar screws** with a **Phillips Head Screwdriver**. *Note: Do not over-tighten.*



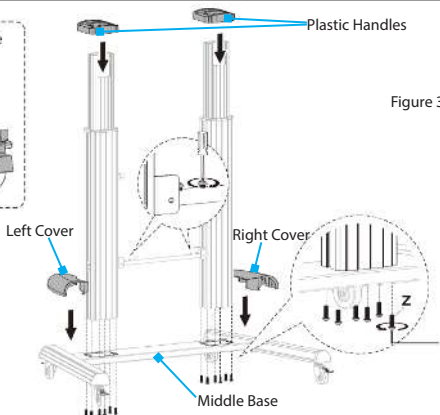
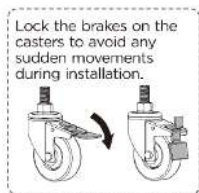
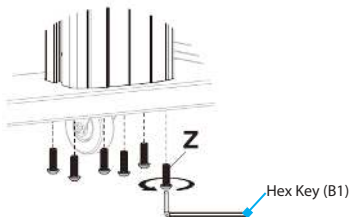

Figure 3

4. Engage the **Brake** on each one of the four **Casters** before proceeding to step 5.
5. Insert the **Left** and **Right Columns** into their respective receptacles, located in the **Middle Base**. (Figure 3)
6. Tilt the entire **Assembly** onto its backside to gain access to the bottom of the **Middle Base**.
7. Attach the **Left** and **Right Columns** to the **Middle Base** using six **M8 x 25mm Screws (Z)**. Tighten screws with the **Hex Key (B1)**.



- Position the assembly upright. Fit the **Plastic Handles** over each column as shown and slide into position on top of the outer columns. (Figure 3)
- Arrange the **Left and Right Covers** onto the frame as shown and snap into position. (Figure 3)

## Install Mounting Plate and Crank Handle

- Attach both **Plastic Covers** to the **Mounting Plate** using four **M6 x 8mm screws (A1)**. (Figure 4)

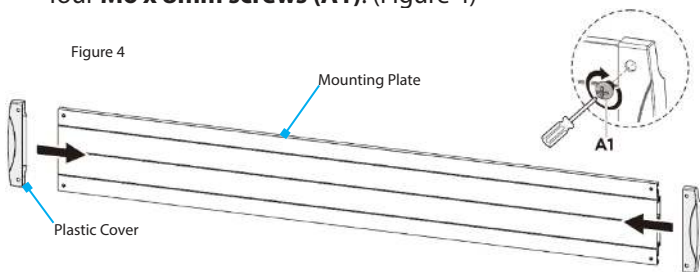

- Attach the **Mounting Plate** to the top mounting points on the **Left and Right Columns** using four **M6 x 14mm screws (Y)**. Tighten with a **Phillips Head Screwdriver**. (Figure 5)

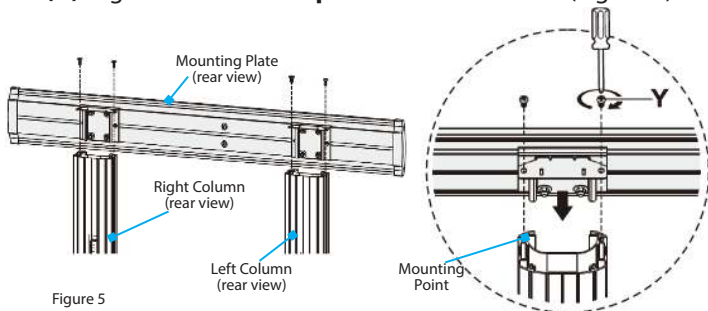
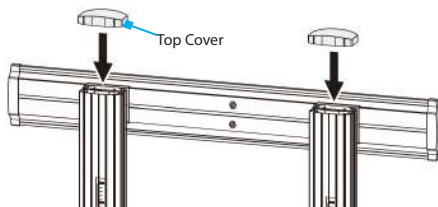

Figure 5

3. Fit the **Top Covers** over the **Left** and **Right Columns** and gently press into position. (Figure 6)

Figure 6



4. Insert the **Crank Handle** into **Outer Left** or **Right Column** as shown. Rotate the **Crank Handle** to raise or lower positioning. (Figure 7)

Figure 7

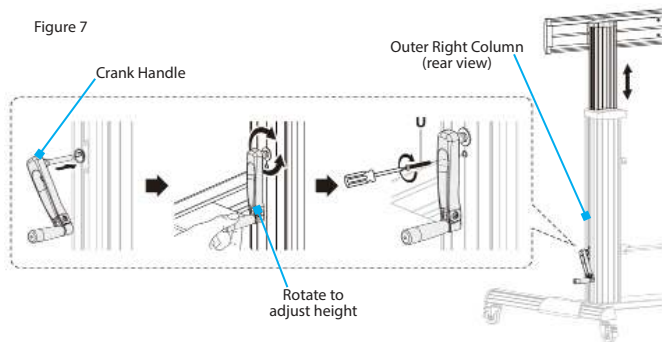

5. Once the desired height has been set, position the **Crank Handle** downward. Insert the **M5 x 40mm screw (U)** through the **Crank Handle** and **Outer Right Column** as shown. Tighten with a **Phillips Head Screwdriver** to secure positioning. (Figure 7)

## Install the Upper and Lower Shelves

**Note:** Install the Lower Shelf first

Figure 8  
(front view)

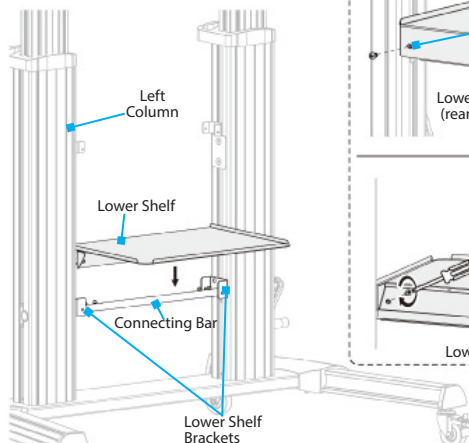

Figure 8a

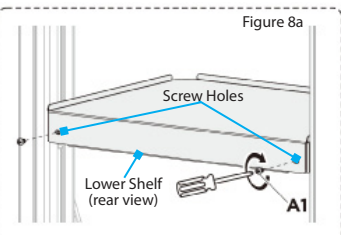
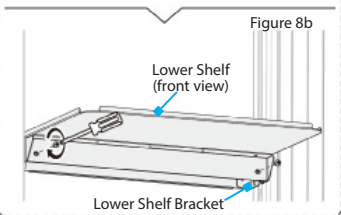

Figure 8b



2. Position the **Lower Shelf** over the **Connecting Bar** and align the front and rear **screw holes** on the **Lower Shelf** with the **Lower Shelf Brackets**. (Figure 8)
3. Mount the **Lower Shelf** to the **Lower Shelf Brackets** using four **M6 x 8mm screws (A1)**. Note that there are four total mounting points. Tighten with a **Phillips Head Screwdriver**. (Figure 8a & 8b)

**Note:** Please attach the lower shelf using all four screws

## Install the Upper Shelf

Figure 9  
(front view)

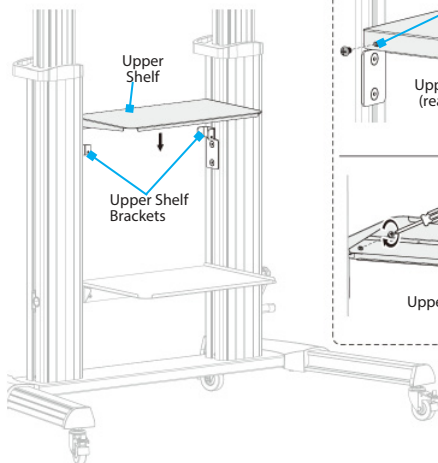

Figure 9a

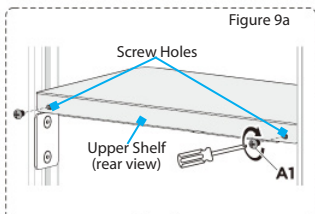
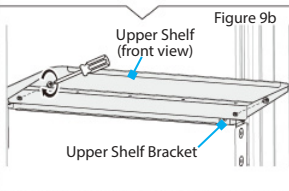

Figure 9b



4. Position the **Upper Shelf** over the **Upper Shelf Brackets** and align the front and rear **screw holes** on the **Upper Shelf** with the **Upper Shelf Brackets**. (Figure 9)
5. Mount the **Upper Shelf** to the **Upper Shelf Brackets** using four **M6 x 8mm screws (A1)**. Note that there are four total mounting points. Tighten with a **Phillips Head Screwdriver**. (Figure 9a & 9b)

**Note:** Please attach the upper shelf using all four screws

## Attach the TV Mounting Brackets

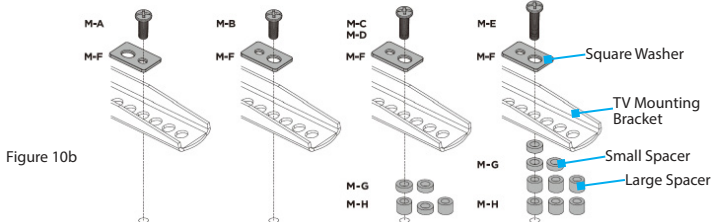
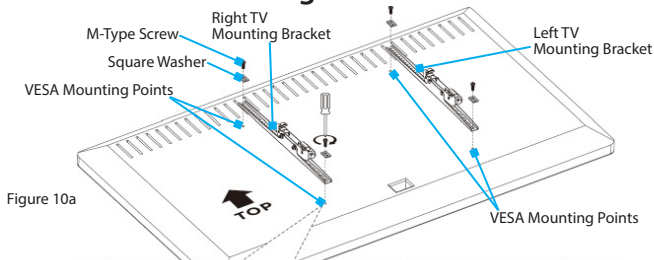

## Warnings!

*Do not over-tighten the screws. If you encounter resistance, stop tightening immediately. Failure to do so could result in damage to the TV.*

*Ensure that the weight of the TV does not exceed the weight capacity of this product. Exceeding the weight capacity may result in personal injury, damage to the product, the attached equipment, and the mounting surface. This product can support a TV up to 100kg/220lbs.*

*Attaching the TV is a two-person job. Do not attempt to complete this task alone.*

*To avoid personal injury and equipment damage, always exercise caution when releasing the TV by supporting its weight until a stable position is achieved.*

1. Determine the **Depth** and **Diameter** of the **VESA Mounting Holes** on the **TV**, and select the appropriate mounting hardware to attach the **VESA TV Mounting Brackets**.
2. Place the **TV** face-down on a protective/soft surface with the **VESA Mounting Points** facing up. (Figure 10a)

3. (Optional) Identify and remove the pre-installed **VESA Hardware** from the back of the **TV**.

**Note:** Not all TVs will have placeholder **VESA Hardware**. Only remove the four **Screws** for the **VESA Mount**. Do not remove any of the screws from the TV's structural assembly.

4. Place the necessary number of **Small (M-G)** and/or **Large Spacers (M-H)** over each **VESA Mounting Hole** on the **TV**. (Figure 10b)
5. Position the **Left** and **Right TV Mounting Brackets** onto the back of the **TV** as shown, aligning with the **TV VESA Mounting Holes** and (Optional) **Spacers**. The **arrows** on the **TV Mounting Brackets** should be pointing towards the top of the **TV**. (Figure 10a)

**Note:** Ensure that the **Left** and **Right TV Mounting Brackets** are positioned at even height and are parallel to each other.

6. Place a **Square Washer (M-F)** on the **TV Mounting Bracket** at each **VESA Mounting Point**, and align the screw hole size on the **Square Washer** to fit the correct **M-Type Screws** for the **TV**. (Figure 10b)
7. Thread the appropriately-sized **M-Type Screws** (e.g. **M5 x 14mm Screws (M-A)**) through the **Square Washers (M-F)**, **TV Mounting Brackets**, (Optional) **Spacers (M-G + M-H)**, and into the **TV**. (Figure 10b)
8. Tighten the **M-Type Screws** using a **Phillips Head Screwdriver**, until each screw sits flush with the surface of the **TV Mounting Brackets**

**Warning:** Do not over-tighten the **M-Type Screws**. If any unexpected resistance is encountered, stop immediately and attempt to use a different length of **M-Type Screw**.

## Mount the TV to the Mounting Plate

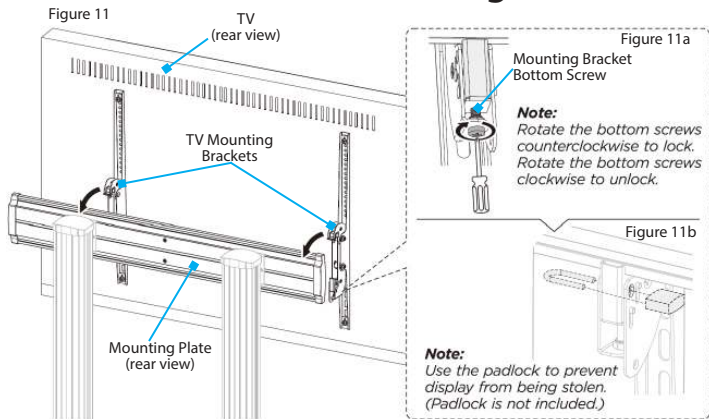

1. Loosen the two **Bottom Screws** located at the bottom of the **TV Mounting Brackets** using a **Phillips Head Screwdriver**. Ensure that the **Bottom Screws** are loosened enough for the **TV Mounting Brackets** to fit onto the **Mounting Plate**. (Figure 11a)
2. With two people, lift and hang the **TV** onto the **Mounting Plate**. Ensure that the hooks on the **TV Mounting Brackets** are hung over the top edge of the **Mounting Plate**. (Figure 11)
3. Position the **TV** along the **Mounting Plate**. Tighten the two **Bottom Screws** counter-clockwise on the **TV Mounting Brackets** using a **Phillips Head Screwdriver** to secure the **TV** to the **Mounting Plate**. (Figure 11 & 11a)

4. (Optional - Locking) Insert a **Padlock** (not included) through the holes, located at the bottom of either **TV Mounting Bracket**. (Figure 11b)

## Assemble the Camera Shelf

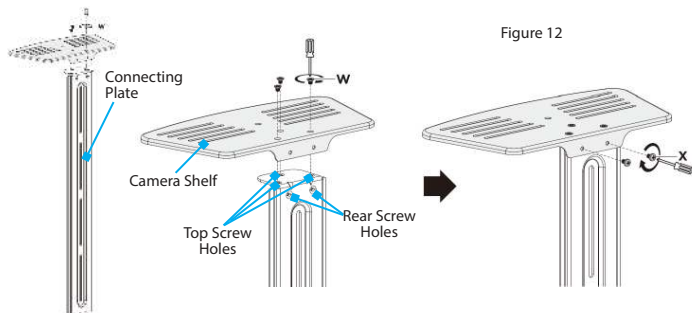

1. Place the **Camera Shelf** flush on top of the **Connecting Plate**. Align the three holes on the top of the **Camera Shelf** with the three holes at the top of the **Connecting Plate**. (Figure 12)
2. Insert three **M4 x 6mm Screws (W)** through the **top screw holes** on the **Camera Shelf**. Tighten with a **Phillips Head Screwdriver** to attach the **Camera Shelf** to the **Connecting Plate**. (Figure 12)
3. Insert two **M4 x 6mm Screws (X)** through the **rear screw holes** on the **Camera Shelf**. Tighten with a **Phillips Head Screwdriver**. (Figure 12)

## Attach the Camera Shelf to the Mounting Plate

Figure 13

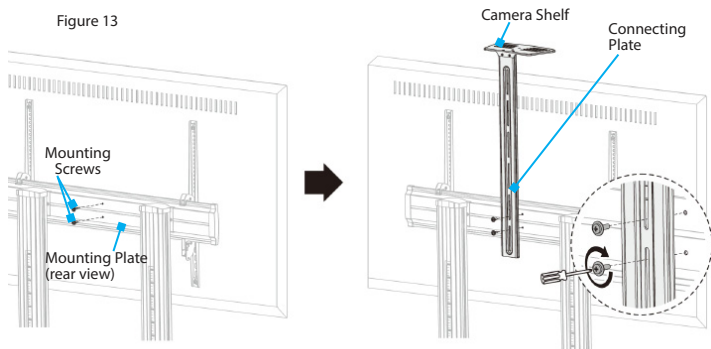

4. Remove the two **Mounting Screws** from the back side of the **Mounting Plate**. (Figure 13)
5. Determine the desired height of the **Camera Shelf** and align the slots on the **Connecting Plate** to the **Mounting Screw Holes** on the **Mounting Plate**.
6. Tighten both **Mounting Screws** using a **Phillips Head Screwdriver** to secure the **Camera Shelf** into position. (Figure 13)

## Operation

### Adjust the Tilt Angle of the TV

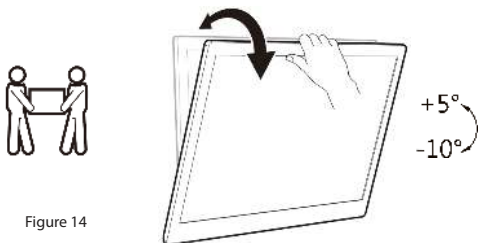

Figure 14

1. The **Mobile TV Cart** features toolless tilt angle adjustment. Hold the **TV** along the **horizontal edges** to tilt the **viewing angle**. (Figure 14)

**Note:** *Two People* may be required for tilt adjustments.

2. Check to ensure that both **TV Mounting Brackets** are attached securely to the **Mounting Plate** and the **TV**. Perform this check at regular intervals.

### Move the Mobile TV Cart

**Warning!** *Never attempt to move the **Mobile TV Cart** with one person. A minimum of **two people** are required to move the **Mobile TV Cart**.*

1. Disconnect and remove the **Web Camera** and any **Media Devices** from the **Mobile TV Cart**.
2. Unplug and move any **Cables** that may interfere with, or prevent, the movement of the **Mobile TV Cart**.

3. Disengage the **Brakes** on the **Casters**.
4. Grip the **Plastic Handles** and the top corners of the **TV** and slowly move the **Mobile TV Cart**, using **two people**. Exercise caution when navigating around corners, over bumps and/or uneven ground.
5. Once the **Mobile TV Cart** is at the desired location, lock the **Brakes** on the **Casters**.

## Adjust the Height of the Upper Shelf

Figure 15

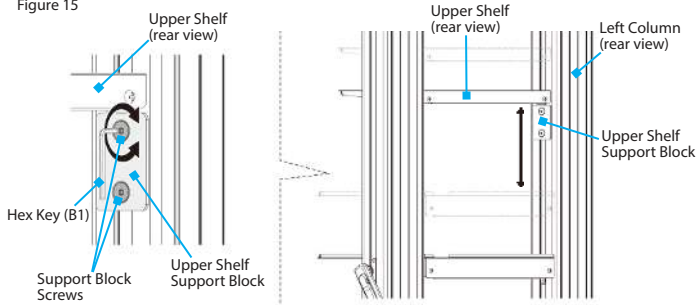

1. Remove all items from the **Upper Shelf** before performing height adjustment.
2. Loosen both **Support Block Screws** on the **Left** and **Right Upper Shelf Support Blocks** using the **Hex Key (B1)**. (Figure 15)
3. Adjust the **Upper Shelf** to the desired height. Tighten both **Support Block Screws** on the **Left** and **Right Upper Shelf Support Blocks** to secure into position. (Figure 15)

## Adjust the Height of the TV Mount

Figure 16

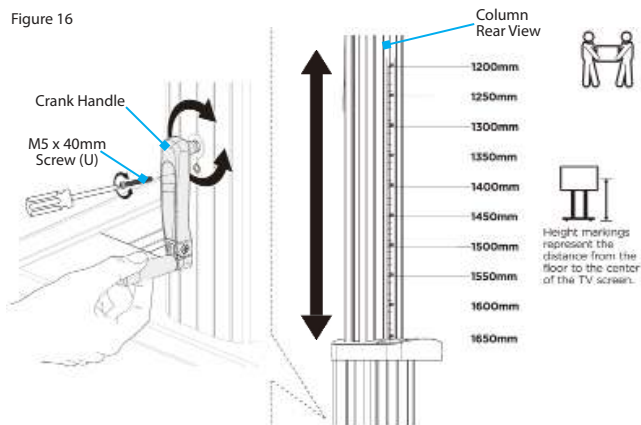

1. Loosen and remove the **M5 x 40mm Screw (U)** from the **Crank Handle** using a **Phillips Head Screwdriver**. (Figure 16)
2. Rotate the **Crank Handle** to raise or lower the **TV Mount** to the desired height.
3. The **Height Markings** on the back of the **Left** and **Right Columns** represent the distance from the floor to the center of the **TV Screen**. (Figure 16)
4. Once the height has been set, insert the **M5 x 40mm Screw (U)** through the **Screw Hole** in the **Crank Handle** and **Outer Right Column**. Tighten with a **Phillips Head Screwdriver** to lock into position.

---

## Attach Adhesive Cable Management Clips

1. Peel and stick the **Adhesive Cable Management Clips** onto the assembly where required, to neatly bundle and organize cables between devices.

---

## Warranty Information

This product is backed by a five-year warranty.

For further information on product warranty terms and conditions, please refer to [www.startech.com/warranty](http://www.startech.com/warranty).

## Limitation of Liability

In no event shall the liability of StarTech.com Ltd. and StarTech.com USA LLP (or their officers, directors, employees or agents) for any damages (whether direct or indirect, special, punitive, incidental, consequential, or otherwise), loss of profits, loss of business, or any pecuniary loss, arising out of or related to the use of the product exceed the actual price paid for the product.

Some states do not allow the exclusion or limitation of incidental or consequential damages. If such laws apply, the limitations or exclusions contained in this statement may not apply to you.

## Hard-to-find made easy. At StarTech.com, that isn't a slogan. It's a promise.

StarTech.com is your one-stop source for every connectivity part you need. From the latest technology to legacy products — and all the parts that bridge the old and new — we can help you find the parts that connect your solutions.

We make it easy to locate the parts, and we quickly deliver them wherever they need to go. Just talk to one of our tech advisors or visit our website. You'll be connected to the products you need in no time.

Visit [www.startech.com](http://www.startech.com) for complete information on all StarTech.com products and to access exclusive resources and time-saving tools.

StarTech.com is an ISO 9001 registered manufacturer of connectivity and technology parts since 1985 with operations around the world.

### Reviews

Share your experiences using StarTech.com products, including product applications and setup, what you love about the products, and areas for improvement.

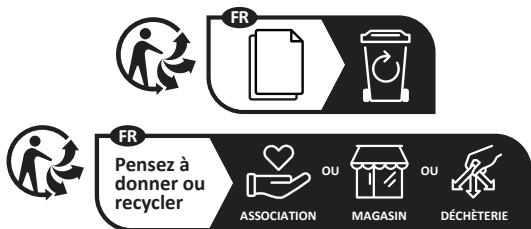

[www.quefairedemesdechets.fr](http://www.quefairedemesdechets.fr)

### StarTech.com Ltd.

45 Artisans Crescent  
London, Ontario  
N5V 5E9  
Canada

### StarTech.com LLP

4490 South Hamilton  
Road  
Groveport, Ohio  
43125  
U.S.A.

### StarTech.com Ltd.

Unit B, Pinnacle 15  
Gowerton Road  
Brackmills,  
Northampton  
NN4 7BW  
United Kingdom

### StarTech.com Ltd.

Siriusdreef 17-27  
2132 WT Hoofddorp  
The Netherlands

FR: [fr.startech.com](http://fr.startech.com)

ES: [es.startech.com](http://es.startech.com)

IT: [it.startech.com](http://it.startech.com)

DE: [de.startech.com](http://de.startech.com)

NL: [nl.startech.com](http://nl.startech.com)

JP: [jp.startech.com](http://jp.startech.com)

To view manuals, videos, drivers, downloads, technical drawings, and more visit [www.startech.com/support](http://www.startech.com/support)