



Product specification:

FM frequency range: 87.8-102.8MHz
 Transmit effective distance: 10M
 SNR: 60dB
 Distortion: <0.1%
 Frequency response: 20Hz-15Khz
 Left and right channel dB: >60dB
 Bluetooth® version: Bluetooth® V2.1+EDR
 Support Bluetooth® profiles: HFP/HSP/A2DP/AVRCP
 Working voltage: DC 9-26V
 Power consumption: <1W
 Working temperature: -10-70
 Degree Working humidity: 0-95%
 Product size: 112mm(L) x 26mm(W)
 x 17(D)mm
 Product Net weight: 42g

8. Do not use this product in an environment with high temperature, dust or moisture.
9. The Bluetooth® function of this product supports background play. If the phone has a cue tone or call, when playing music with AUX/Line cable, it will be automatically switched to Bluetooth® mode. It will return to AUX/Line cable connection after ending the cue tone or call.

Attention

1. The product contains dual USB outputs. It can charge two devices at the same time with a maximum output of 5V/2.1A.
2. This product is supplied with an AUX/Line cable.
3. Never have the volume too loud (generally at 28 or below) when the FM is working so as to avoid sound distortion. Please adjust the sound volume through the car audio.
4. To get the best results from the Bluetooth® transmitter, always tune the transmitter to an FM frequency with NO station transmitting.
5. Bluetooth® operation may vary depending on make/model of phone.
6. This product is compatible with more than 95% phones on the market.
7. The volume should be medium during phone calls to avoid affecting the other party.



Streetwize Accessories:
 Unit 1, Royce Trading Estate, Ashburton Road West,
 Trafford Park, Manchester M17 1RY

Sales enquiries: sales@streetwizeaccessories.com
Technical enquiries: support@streetwizeaccessories.com
Telephone: 0161 447 8597
www.streetwizeaccessories.com



12/24V Car Bluetooth® FM Transmitter

Play music or make a phone call from an Android/iOS phone through your FM radio.

Transmit music from your phone to your vehicle sound system wirelessly. Plus answer calls through the hands-free mode via the Bluetooth® transmitter, as long as the mobile phone features a Bluetooth® function. When the call is finished, it will automatically switch back to play music.



Please read and understand this manual before any use of this product, and retain for future reference.





Descriptions of the Schematic Diagram

- | | |
|-------------------------------|--|
| 1. Volume Up/Down/CH+/CH- | 6. Hang up/Reject a call.
Press and hold to switch to CH FM mode. |
| 2. Bluetooth® power switch | 7. LED display window |
| 3. Audio input | 8. 9V-24V Power adaptor |
| 4. Power indicator lamp | 9. USB output:
5V/2.1Amp - total |
| 5. Answer/Redial - Play/Pause | |

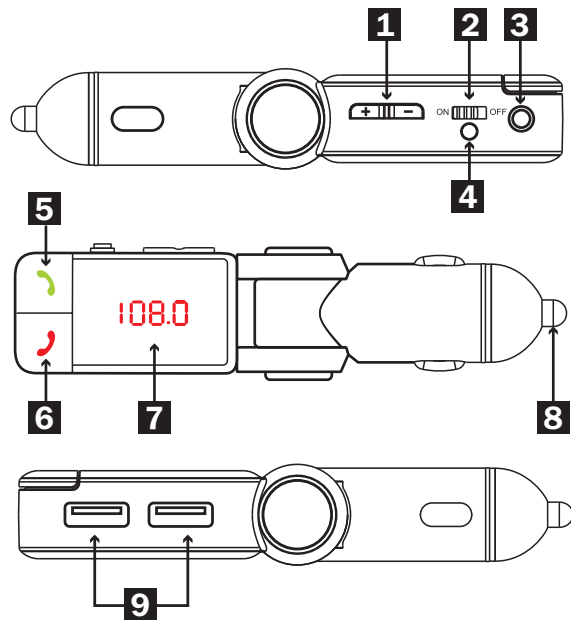

Product Features

- Adjusts to any angle & applicable for all types of vehicles
- FM transmitter
- Large LED display window
- LINE audio input
- Independent Bluetooth® start/shutdown button
- Answer/hang up/reject/redial the via Bluetooth®
- Bluetooth stereo music player
- Call Echo Cancellation and Noise Reduction (CVC) technology
- Dual USB output voltage, provides powers to other devices and the maximum output is 5V/2.1A
- Automatic memory function of power failure frequency point

Operation Instructions

Bluetooth® mode

1. Plug the product into the vehicles 12V power socket and switch the power to ON. The Bluetooth® transmitter will start up, and the LED screen will display the frequency point once it is powered.
2. To connect a mobile to Bluetooth® hands-free transmitter for the first time, connection is required.
3. Enable the Bluetooth® function of the phone while the Bluetooth® transmitter is on and search for "BC-06/Car kit" device, which will display on your phone.
4. Select "BC-06/Car kit" and pairing automatically begins. A prompt sound will be given after pairing.

Making a call

Whilst a phone is connected dial the number required as you would normally in connection state and ring tone sound will be given out from car audio.

Press the  key to hang up.

Answering a call

If there is an incoming call when connected, press the  key to answer the call.

In answering the call, press the  key to switch between the mobile phone microphone and the product microphone.

Press the  key to hang up.

Callback

Press the  key twice when connected to call back the last call.

Reject a call

For calls you do not want to answer, you may press the  key to reject.

Playing music from your phone

This product supports A2DP function, which allows you to play music through your phone when connected to Bluetooth®. Music will be transmitted to your car audio via FM function of the product.

While connected press the  key to play/pause (**please note:** some phones with lower system versions may not support this function).

Audio input mode

You can connect to the FM transmitter when Bluetooth® is NOT available insert the line in cable with one end inserted to the sound source socket (3), and the other end to the product audio socket.

Press the  to turn up/down the volume, and press and hold it to turn up/down volume quickly.

Please Note: Audio cables need to be linked to the external audio device first, and then inserted into the audio input socket, otherwise it will not play music through the device.

FM Adjustment

Press and hold the  key to enter the frequency selection state. At this time, the frequency point on the LED window will flash.

Press the + key to increase/decrease the frequency. Press and hold the – key to increase/decrease the frequency quickly.

Frequency is adjustable within 87.5 - 108MHZ.

Power-off memory

When you turn this product off, the system will memorize the FM frequency and Bluetooth® that connects to the phone automatically in order to facilitate your usage.