

USE AND CARE GUIDE

Decorative Vertical File Cabinet with Safety Lock

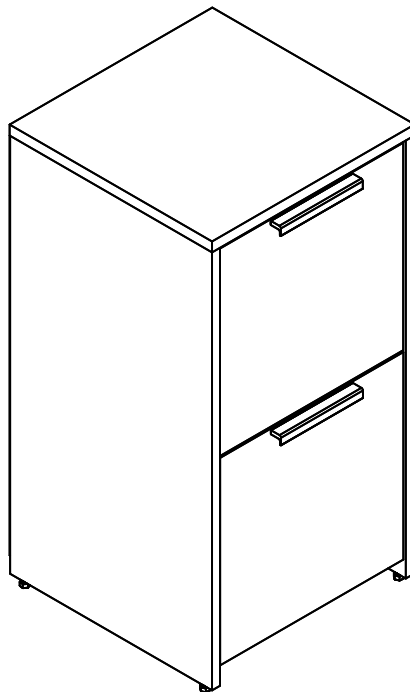

Questions, problems, missing parts?
Before returning to the store, call Customer Service.
8 a.m. – 7 p.m., EST, Monday – Friday, 9 a.m. – 6 p.m., EST, Saturday

1-877-527-0313

HOMEDEPOT.COM

THANK YOU

We appreciate the trust and confidence you have placed in StyleWell through the purchase of this File Cabinet. We strive to continually create quality quality products designed to enhance your home. Visit us online to see our full line of products available for your home improvement needs. Thank you for choosing StyleWell!

Table of Contents

Table of Contents	2	Pre-assembly (continued)	5
Safety Information	2	CAM Fastening system	6
Warranty	2	Assembly	7-14
1 Year Warranty	2	Troubleshooting	15
What is Covered	2	Maintenance	15
What is Not Covered	2	Care and Cleaning	15
Pre-assembly	3		
Planning Assembly	3		
Tools Required	3		
Hardware Included	4		

Safety Information



DANGER

- Keep small parts away from children during assembly.
- Read and follow instructions carefully.



WARNING

- Read these instructions carefully and keep in a safe place.
- TO GUARANTEE THE SAFE USE OF THIS PRODUCT, FOLLOW THE WARNINGS, GUIDELINES AND RECOMMENDATIONS IN THIS MANUAL.**
- Adult assembly required.
- Small parts may present choking hazard prior to assembly.
- Do not stand, step or climb on unit.



CAUTION

- Do not use power tools to assemble your furniture. Power tools may strip or damage parts/product.
- Do not overtighten connectors (screws, bolts, etc.). Overtightening can lead to product damage.
- Be sure to check all packing materials carefully for small parts that may have come loose inside the carton during shipment. If parts are missing, contact THE HOME DEPOT to obtain any missing parts.
- DO NOT USE SUBSTITUTE PARTS.**
- This product should only be used on a flat, level surface.
- Read these instructions carefully and retain them for future use. If this product is passed to a third party, then these instructions must be included.
- Assembly requires two people; assembly alone may cause injury.
- Before using the product be sure that it is completely and properly assembled.
- During assembly children should be kept away from the product to avoid possible risk of injury.
- Regularly check screws to ensure they are tightened securely.

Warranty

1 YEAR WARRANTY

WHAT IS COVERED

We guarantee this product to be free of manufacturing defects to the original purchaser for one year.

WHAT IS NOT COVERED

This warranty does not cover commercial use, acts of nature, and abusive use.

Pre-assembly

PLANNING ASSEMBLY

- Remove all Packaging materials, staples and packing straps from the carton.
- Refer to Parts List and Hardware List, and ensure parts and hardware are correct before assembly.
- Contact customer service for missing parts.
- Place all wooden parts on a clean, flat, and soft surface (e.g. carpet or rug) to prevent scratch and damage to parts

TOOLS REQUIRED



Safety goggles
(Not Included)

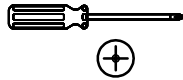

Phillips
screwdriver
(Not Included)

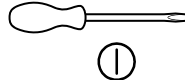

Slotted
Screwdriver
(Not Included)

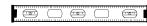

Level
(Not Included)

Pre-assembly

HARDWARE INCLUDED



NOTE: Hardware not shown to actual size.
The bigger DD dowel are used for cabinet panel D, and EE the smaller dowel are used for drawer panel H, I & J.



AA

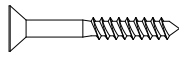

BB

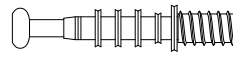

CC

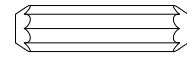

DD

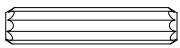

EE



FF

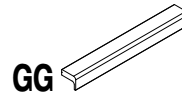

GG



HH

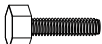

II



JJ



KK



LL



OO

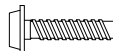

PP

Part	Description	Size	Quantity
AA	Screw	3.5 x 14 mm	10
BB	Screw	4 x 30 mm	8
CC	Locking pin	7 x 39 mm	16
DD	Dowel	8 x 30 mm	8
EE	Dowel	6 x 30 mm	4
FF	Locking nut	15 x 12 mm	8
GG	Handle	160 x 20 mm	2
HH	Locking nut	15 x 10 mm	8
II	Leg levelers bolt	6 x 30 mm	4
JJ	Leg levelers nut	17 x 6.5 mm	4
KK	Screw	4 x 14.5 mm	1
LL	Bracket	76 x 32 mm	1
OO	File runner	336 x 21 mm	4
PP	Screw	4 x 20mm	4

Pre-assembly (continued)

PANELS INCLUDED

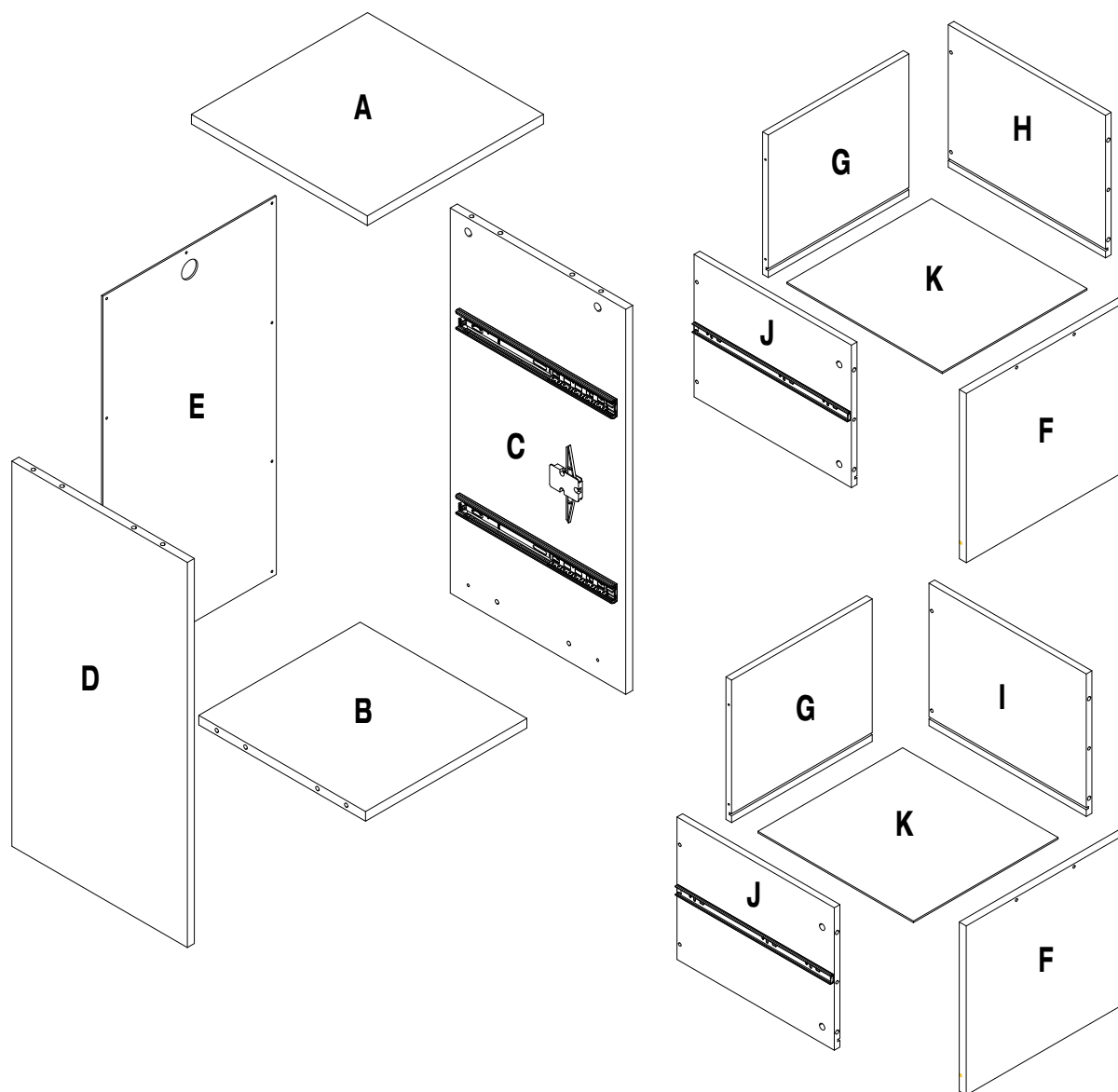

Part	Description	Size	Quantity
A	Top panel	395 x 395 mm	1
B	Bottom panel	375 x 363 mm	1
C	Right side	394 x 742 mm	1
D	Left side	394 x 742 mm	1
E	Back panel	390 x 729 mm	1
F	Drawer front	356 x 350 mm	2
G	Drawer back	313 x 274 mm	2
H	Upper drawer right	350 x 274 mm	1
I	Lower drawer right	350 x 274 mm	1
J	Drawer left	350 x 274 mm	2
K	Drawer bottom	322 x 346 mm	2

CAM Fastening system

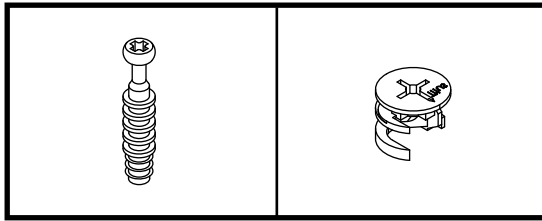

Assembly

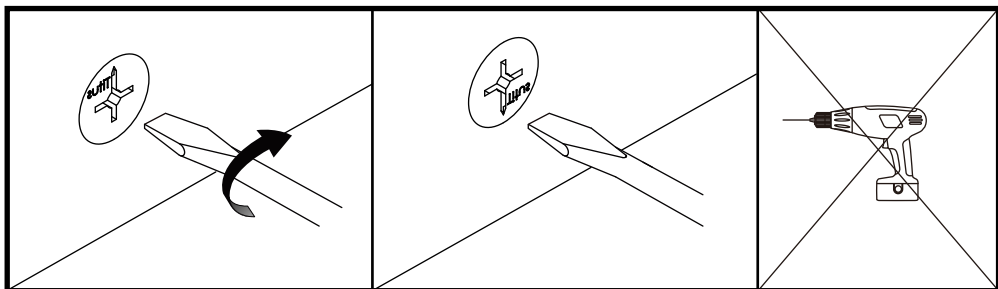
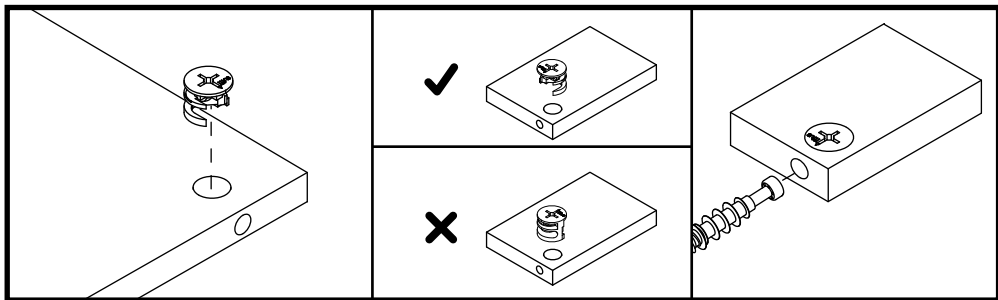
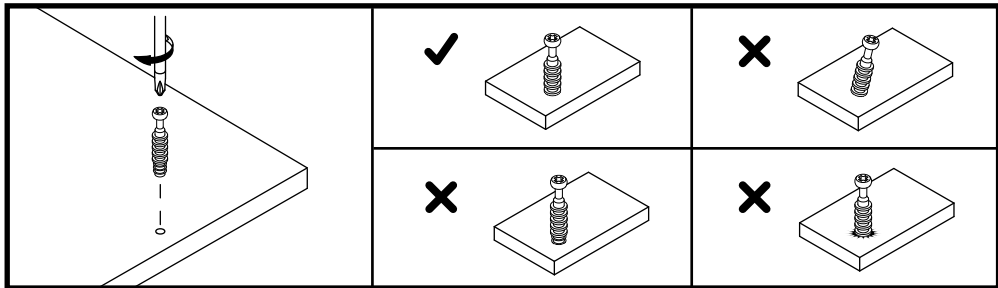

Disassembly

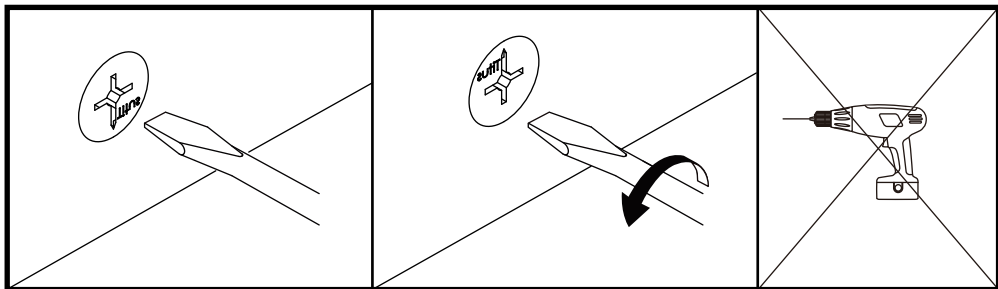

Assembly

1 Side & bottom panel assembly

▫ Metal parts & dowel preparation

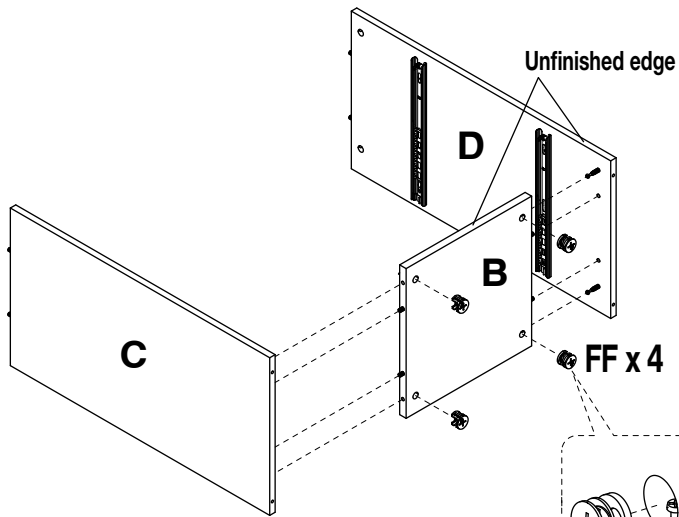
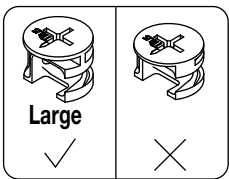
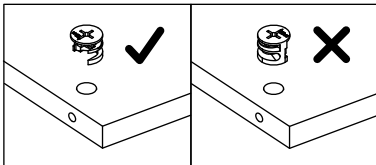
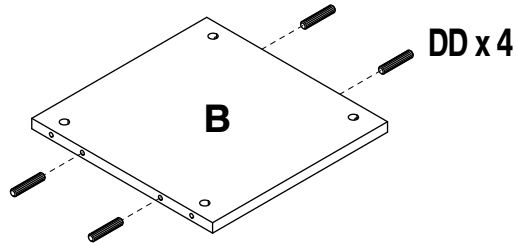
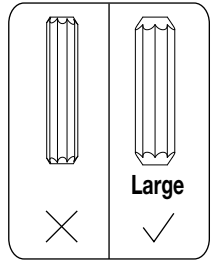
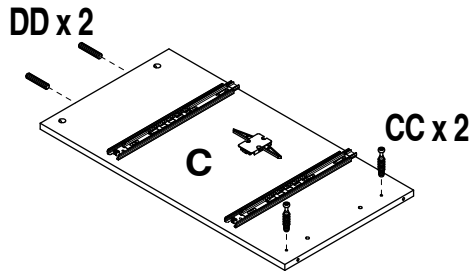
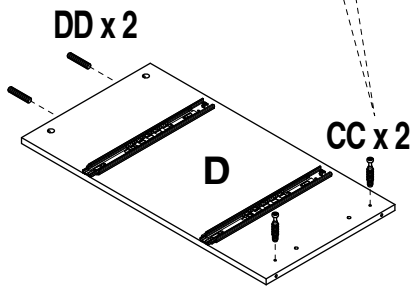
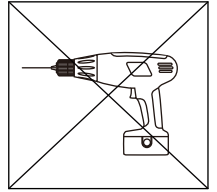
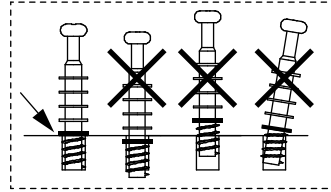
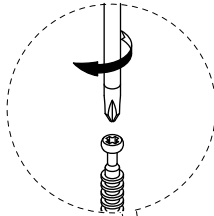
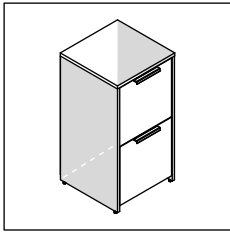

It takes 2 adults to safely assemble this step

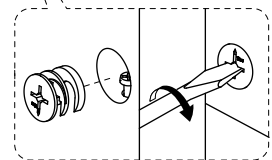

CC x 4

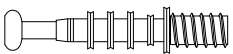

DD x 8

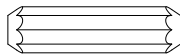

FF x 4



Assembly

2 Top assembly

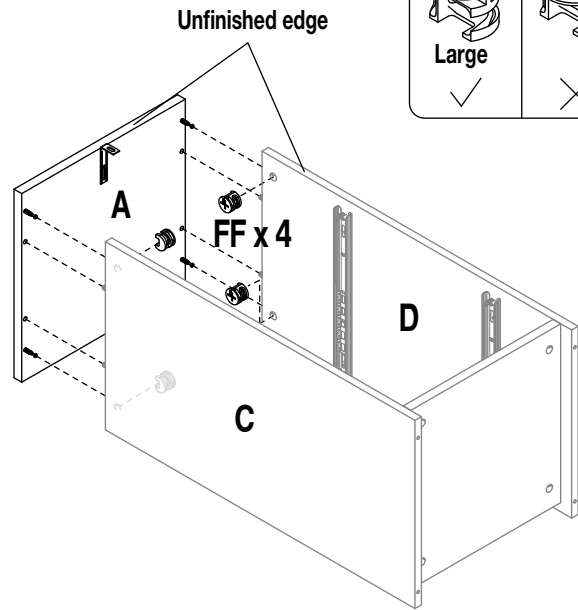
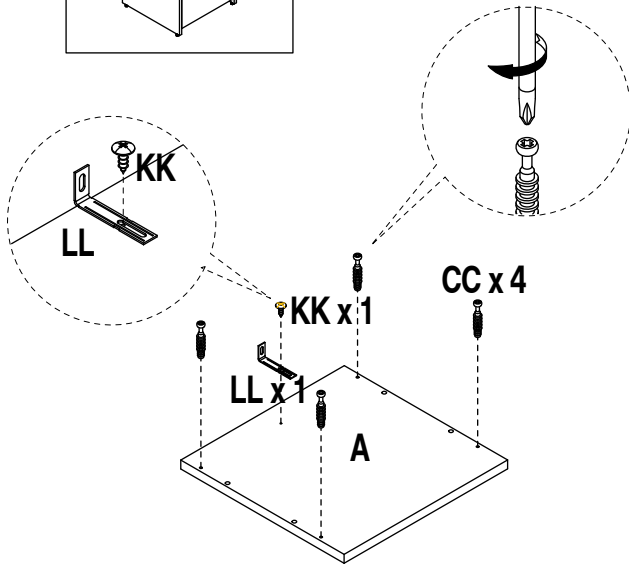
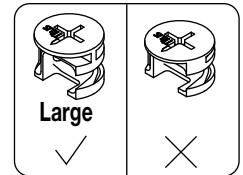
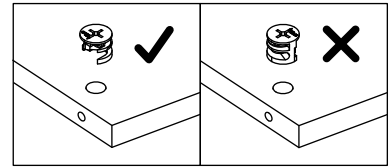
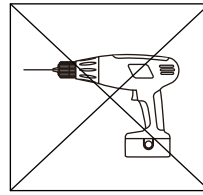
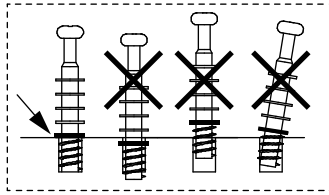
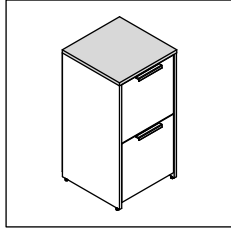

3 Attaching back panel and leg levelers

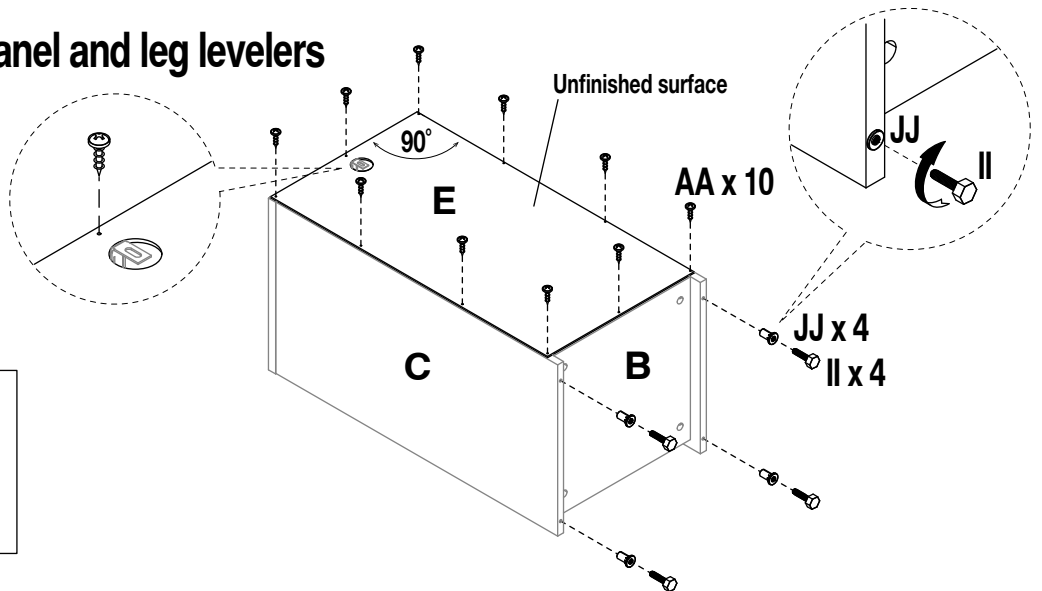
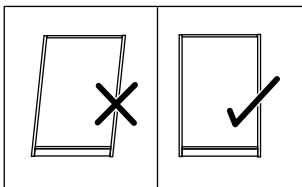
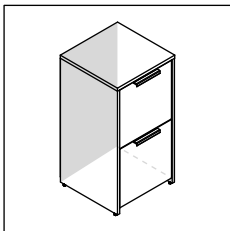

AA x 10



CC x 4



FF x 4



LL x 1



KK x 1



JJ x 4



II x 4

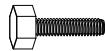

Assembly

4 Upper drawer assembly

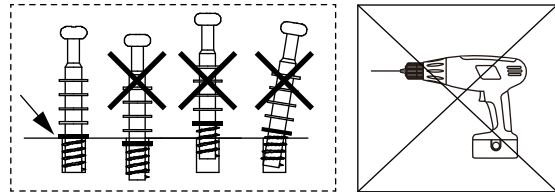
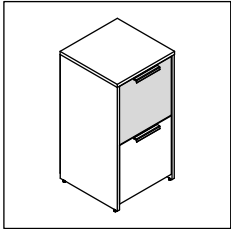

a) Drawer front and upper drawer right preparation

c) Attaching Drawer bottom & Back

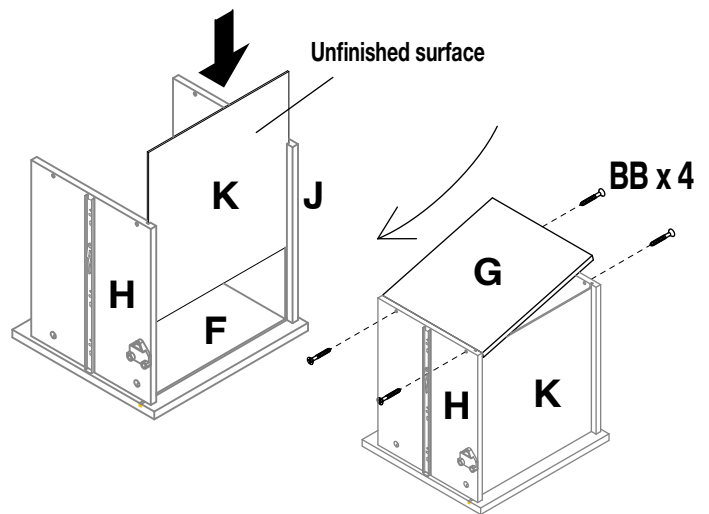
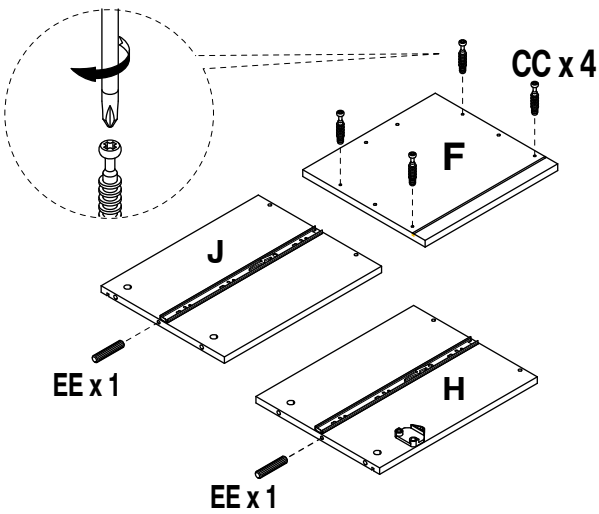

b) Attaching drawer sides

d) Attaching handle

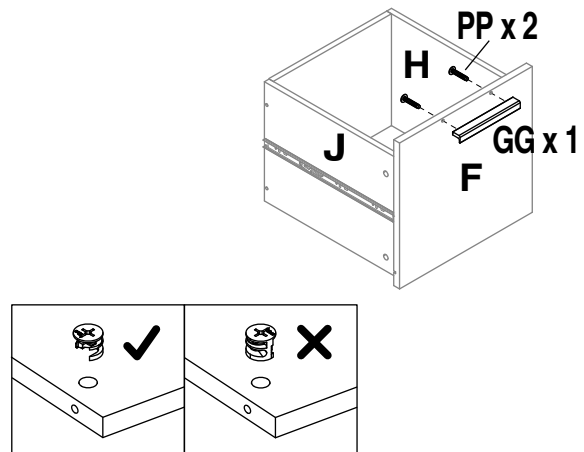
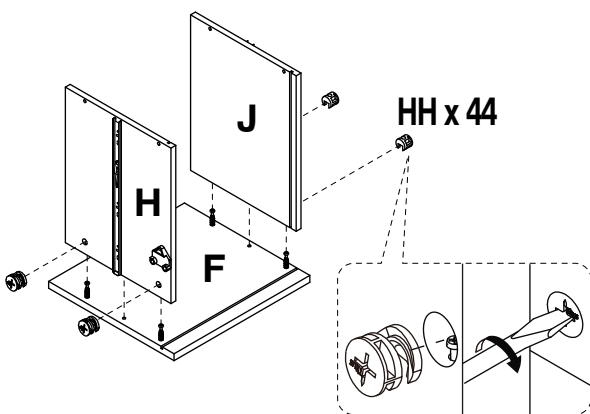

BB x 4

CC x 4

EE x 2

HH x 4

PP x 2

GG x 1

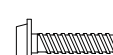
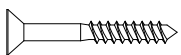

Assembly

5 Lower drawer assembly

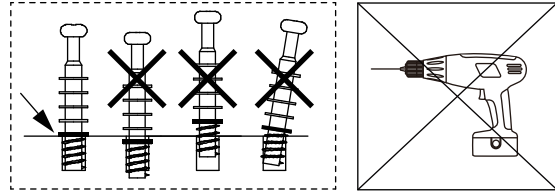
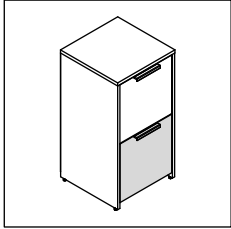

a) Drawer front and lower drawer right preparation

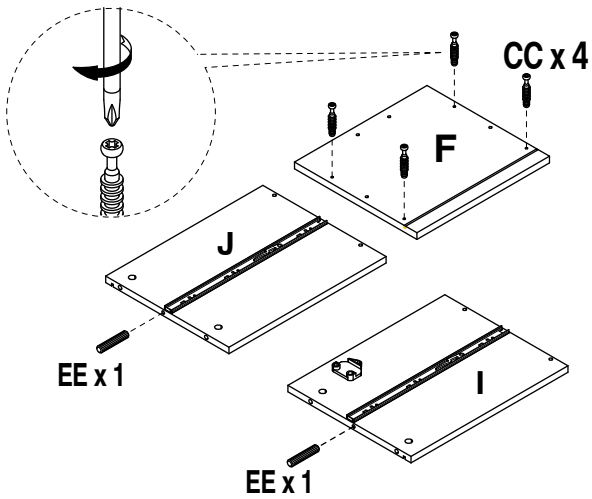

c) Attaching Drawer bottom & Back

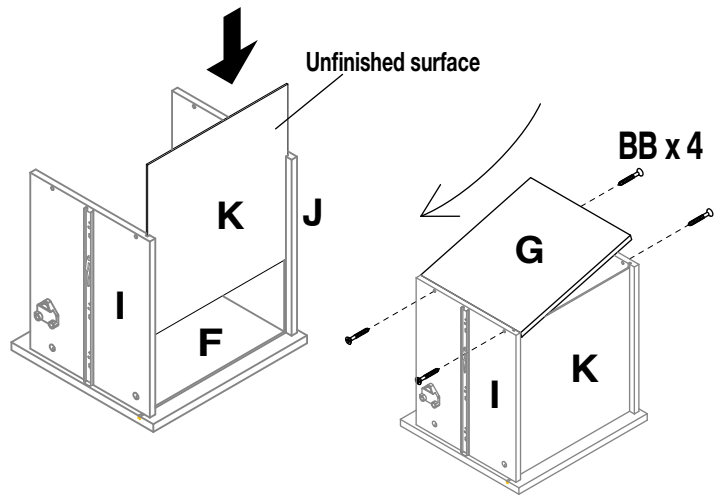

b) Attaching drawer sides

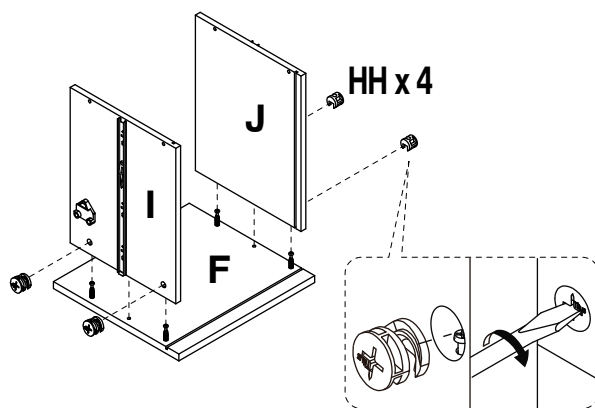

d) Attaching handle

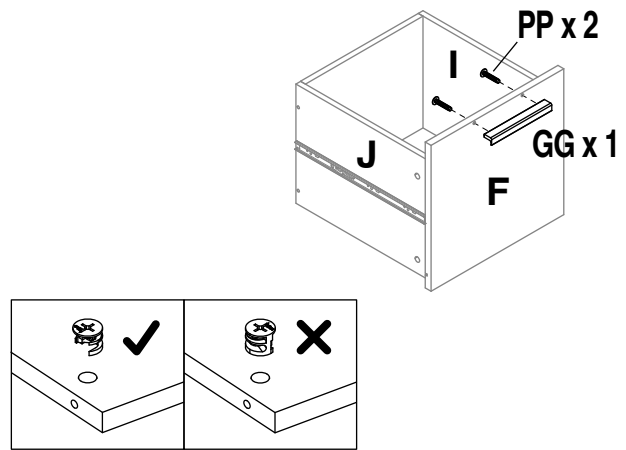

BB x 4

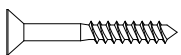

CC x 4



EE x 2



HH x 4



PP x 2

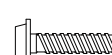

GG x 1



Assembly

6 Fixing to wall

- Drill a hole and insert Wall plug.
- Fixing the unit onto the wall use screw.



NOTE: Make sure that the screws and wall plugs being used are suitable for supporting your unit.

Safety notice

The consumer product safety commission recommends anchoring furniture in homes where children live or visit. In order to protect you and your family the manufacturer of this product has included an easy to install safety device. To hide the bracket behind the unit, drill the hole lower than the top of unit.

Warning: Always ensure intended wall area to be drilled is free from hidden electrical wires, water, and gas pipes.

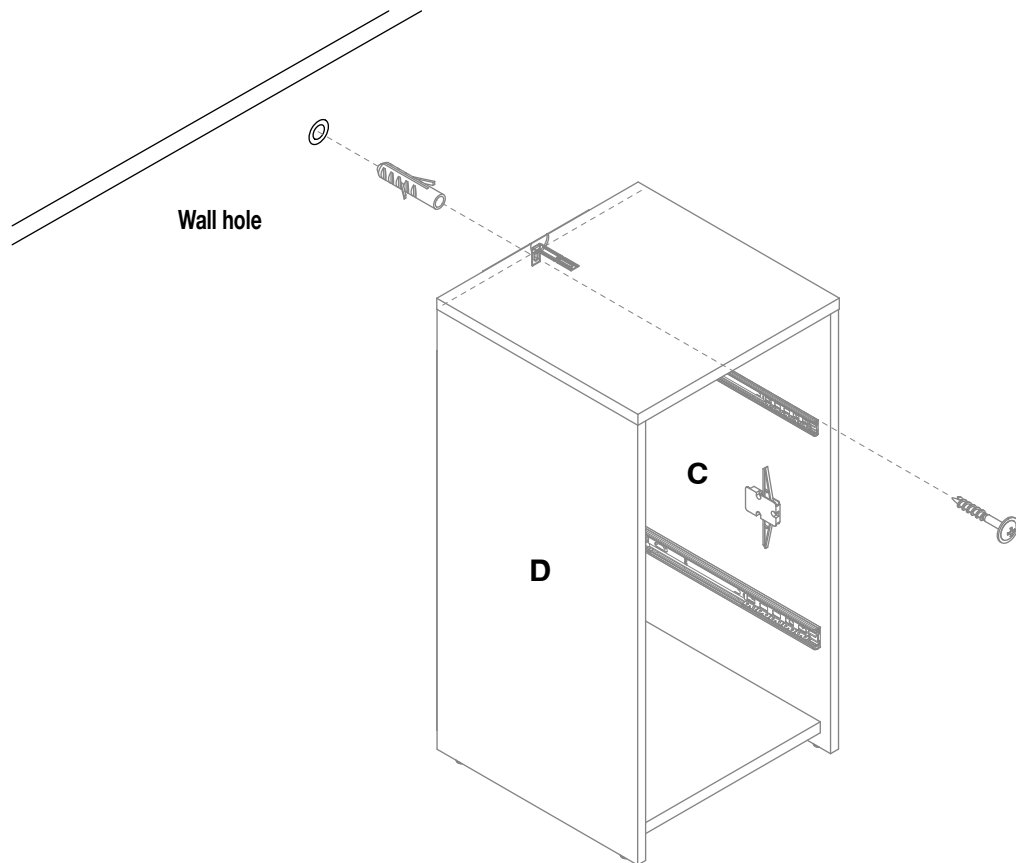

Assembly

7 Inserting drawers

- Insert drawer into cabinet and close. the drawer slide release lever will lock as drawer is closed.
- Make sure drawer aligns properly and rides smoothly on the side mount drawer slides.



NOTE: When removing the drawer, tip up and press down the safety release tab to remove the drawer from the body.

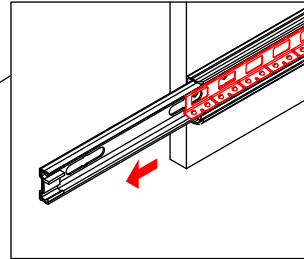
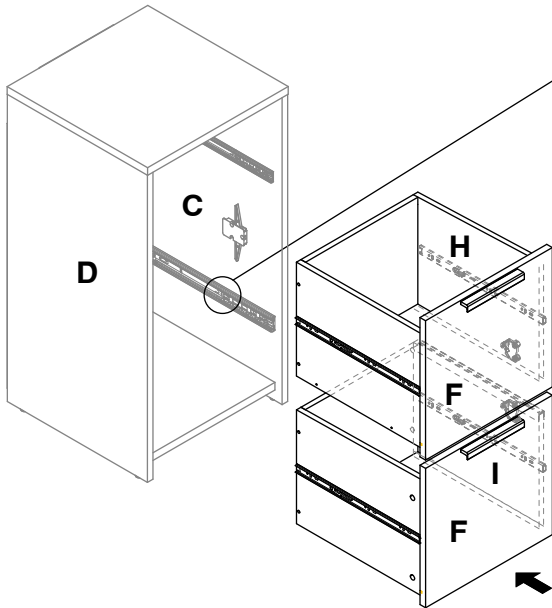

A: Pull out slide & bearings outside to the photo marked.

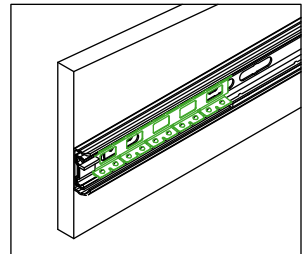
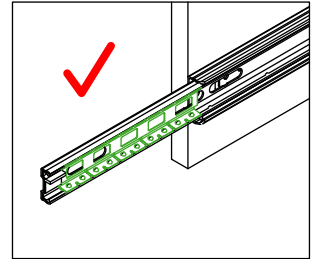

B: Push slide back inside before attach the drawer to the frame.

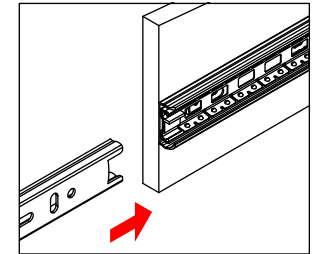

C: Insert into slide slot and push drawer. Insert into slide slot and push drawer.

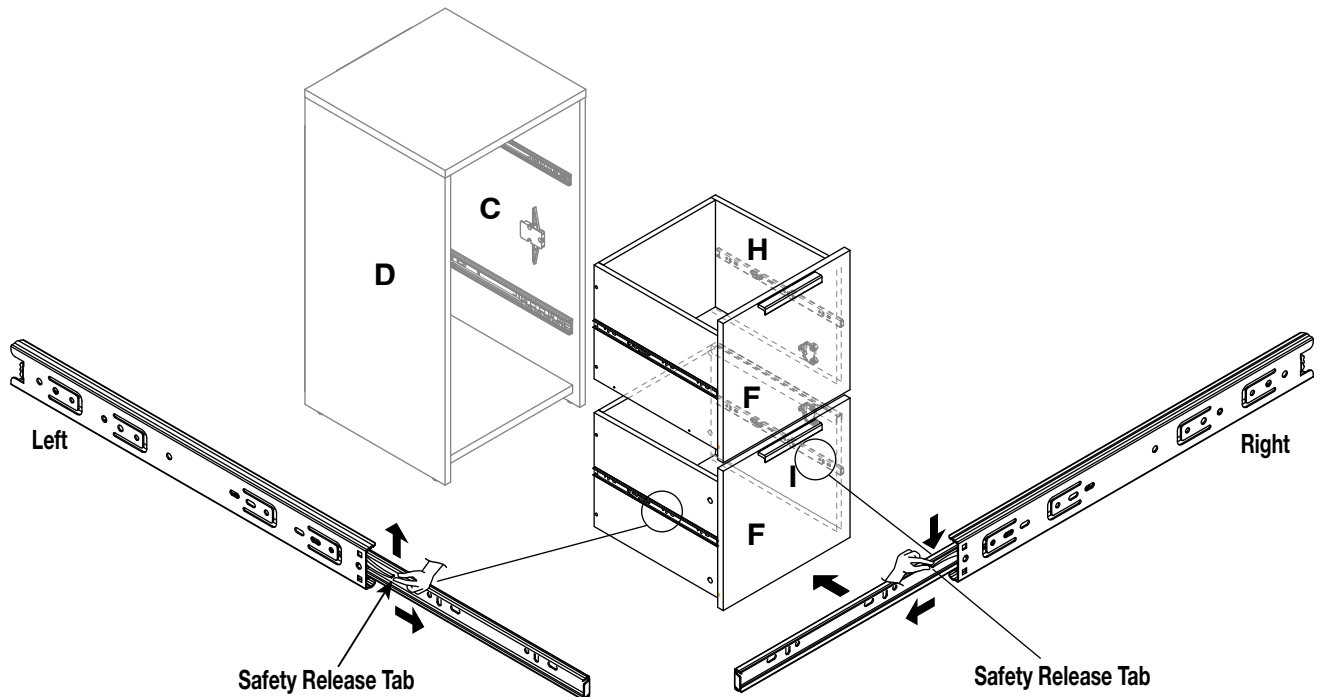

8 Attaching the file runner

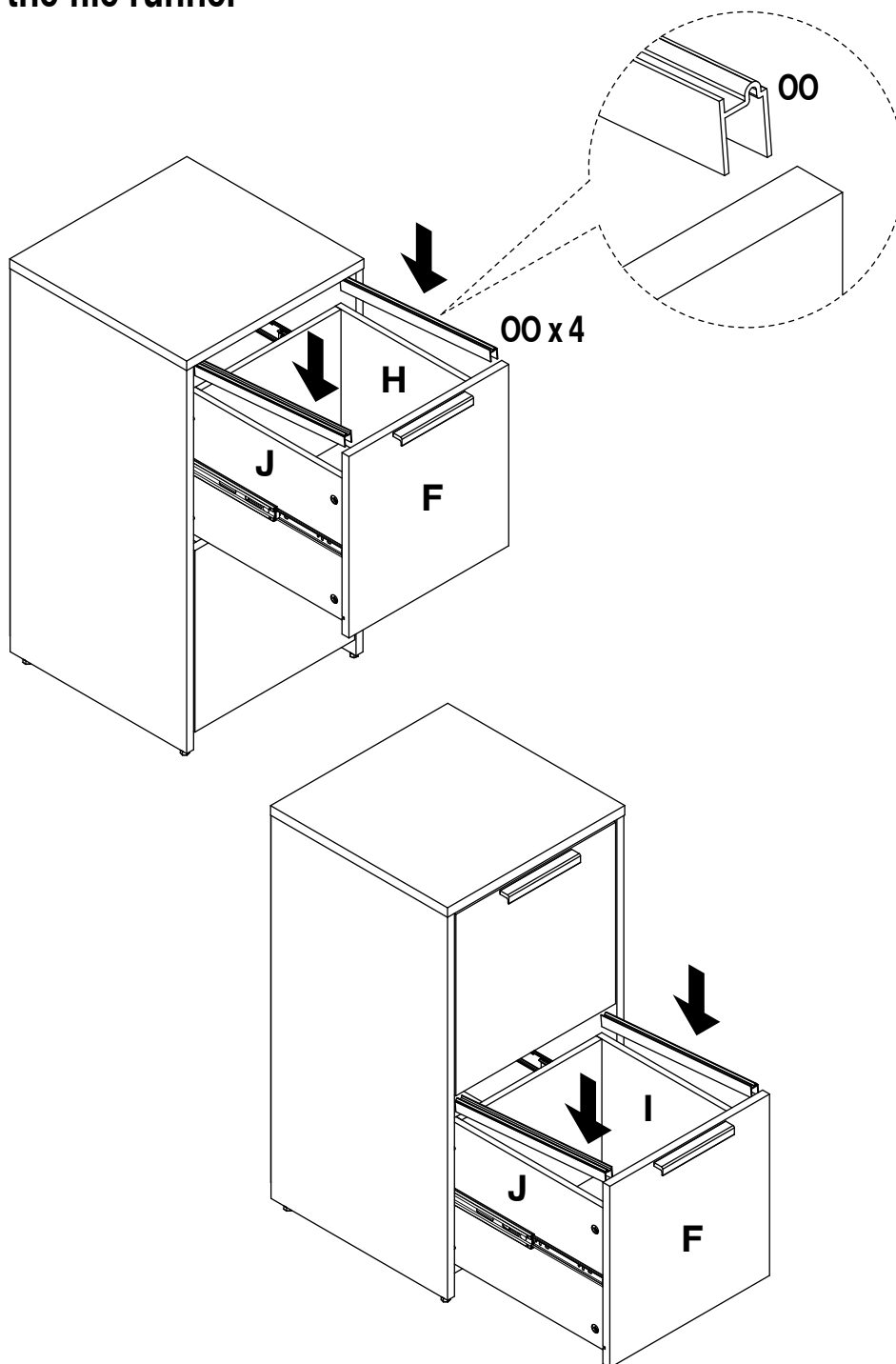

00 x 4



9 Adjusting the leg levelers

- If the ground is not even the unit will be unstable, you can adjust the foot leveler under the leg.
- Turn left to tighten, turn right to loosen.

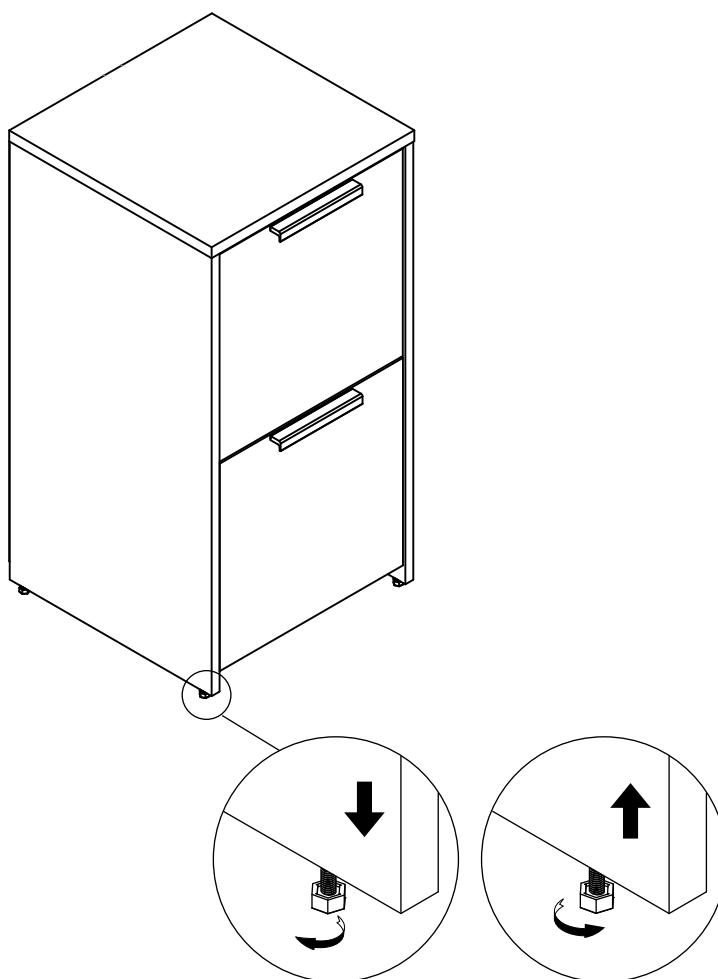

Troubleshooting

Problems	Solutions
Drawer cannot be attached to product	Check if drawer two side boards slides are assembled backwards.
Drawer can not pull in or pull out smoothly	Check drawer attached frame slide bearing pull outside before assembly. Please refer to drawer assembly section.
Drawer cannot be removed	When removing the drawer, tip-up the safety release tab to remove the drawer from the body.
Door cannot be closed / not flat	Adjust the euro hinge make sure it is assembled on appropriate position.
Not all leg touch the ground	Make sure adjustable center feet levelers are adjusted properly. The levelers are pre assembled on the bottom of the legs.
Panel cannot be assembled	Make sure panel is on right direction. Refer to IM details.

Maintenance

- **Keep the product away from direct heat and sunlight .**
- **Prolonged exposure to heat sources may cause scorching, or even cause color to fade .**
- **Regular vacuuming or light brushing helps to remove dirt and prevent soil build-up, which increases the appearance of wear .**
- **Periodically (every 90 days) make sure that the screws are fully tightened .**

Care and Cleaning

- **Handle with care.**
- **Use a slightly damp cloth to clean the product. Do not use bleach or use abrasive cleaning material .**
- **Check all the fittings periodically and re-tighten as necessary. Do not use the product if any of the parts are damaged or broken .**
- **Never allow any kind of liquid to remain on your furniture .**
- **Absorption can make wood warp or delaminate .**
- **Do not place hot items (e.g. hot drinks) directly onto the wood surface.**
- **Do not drag and /or pull the furniture .**
- **Never use harsh chemicals or solvents on your product as this may damage the metal .**
- **Marks and stains from pens, crayons and ink markers are difficult to remove. In the event that your products become permanently stained, we recommend that you consult a professional .**

StyleWell™

**Questions, problems, missing parts?
Before returning to the store, call Customer Service
8 a.m. – 7 p.m., EST, Monday – Friday, 9 a.m. – 6 p.m., EST, Saturday**

1-877-527-0313

HOMEDEPOT.COM

Retain this manual for future use.