

Sylvox

Bathroom TV



USER'S MANUAL

Note: Reserved installation hole (detailed on page 6)

Note: The product and illustrations in this user's manual is only for explanation purposes and may vary depending on model.

English

USER'S MANUAL

Deutsch

BEDIENUNGSANLEITUNG

Français

MANUEL DE L'UTILISATEUR

Italiano

MANUALE D'UTENTE

Español

MANUAL DE USUARIO

General Information

To avoid damaging the television set please observe the following safety instructions during setup and use.

Cleaning the television set	Before cleaning, disconnect the television set. Use only a soft damp cloth or a special cleaning product for flat-screens.
LED Display	Too much pressure on the screen can damage the television set.
Heat/damp/humidity	The television set should not be exposed to high temperatures (radiators, open fire). The television set should not be used in areas with high humidity.
Condensation	If moved from a cool area to one with a higher temperature, the television set should be left for at least an hour before plugging it in. A rapid change of temperature can lead to the formation of condensation in the television set itself. This can lead to damage if the television set is in use.
Air Circulation	To prevent overheating of the television set the ventilation slots at the rear should always be clear.
Small Objects	It is important to ensure that no small objects or liquids enter the television set. They can cause damage or even fire.
Crushing	Take care to avoid crushing fingers or other objects when turning the television set in any direction.
Electric Supply	Use the television set only with the voltage indicated in the specifications. Ensure that there is easy access to the plug and that the television set can always be disconnected from the electricity supply. Do not disconnect the television set by pulling the power cable. Always take hold of the plug. The power cable must not be kinked or placed over sharp edges.
Moving the Television Set	When moving the television set, hold only the casing.
Repairs/Accessories	Repairs and servicing must be undertaken only by authorised and trained personnel.
	In accordance with the Batteries Regulation, batteries are to be disposed of only in containers provided for this purpose.



In extreme weather (storms, lightning) and long inactivity periods (going on holiday) disconnect the TV set from the mains. The mains plug is used to disconnect TV set from the mains and therefore it must remain readily operable. If the TV set is not disconnected electrically from the mains, the device will still draw power for all situations even if the TV is in standby mode or switched off.

IMPORTANT - Please read these instructions fully before installing or operating
WARNING: Never let people (including children) with reduced physical, sensory or mental capabilities or lack of experience and / or knowledge use electrical devices unsupervised.

- For ventilation purposes, leave at least 5cm of free space around the TV.
- The ventilation should not be impeded by covering or blocking the ventilation openings with items, such as newspapers, table-cloths, curtains, etc.
- The power cord plug should be easily accessible. Do not place the TV, furniture, etc. on the power cord. A damaged power cord/plug can cause fire or give you an electric shock.
- Handle the power cord by the plug, do not unplug the TV by pulling the power cord. Never touch the power cord/plug with wet hands as this could cause a short circuit or electric shock. Never make a knot in the power cord or tie it with other cords. When damaged it must be replaced, this should only be done by qualified personnel.
- Do not expose the TV to dripping or splashing of liquids and do not place objects filled with liquids, such as vases, cups, etc. on or over the TV (e.g., on shelves above the unit).
- Do not do not place open flames such as lit candles on the top of or near the TV.
- Do not place any heat sources such as electric heaters, radiators, etc. near the TV set.
- Do not place the TV on the floor and inclined surfaces.
To avoid danger of suffocation, keep plastic bags out of the reach of the babies, children and domestic animals.
- Do not dispose of the batteries in fire or with hazardous or flammable materials.
Warning: Batteries must not be exposed to excessive heat such as sunshine, fire or the like.
- If you think batteries might have been swallowed or placed inside any part of the body, seek immediate medical attention.

WALL MOUNTING WARNINGS

Read the instructions before mounting your TV.

Do not install the TV on an inclined.

Use the specified wall mounting screws and other accessories.

Tighten the wall mounting screws firmly to prevent the TV from fall.

Do not over-tighten the screws.

A television set may fall, causing serious personal injury or death. Many injuries, particularly to children, can be avoided by taking simple precautions such, Educating children about the dangers of climbing on furniture to reach the television set or its controls.

Accessories

Please make sure the following items are included with your TV.
 If any items are missing, Please contact us.



Remote Control



Screwdriver



Television

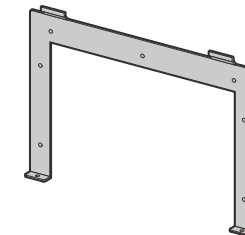

Bracket

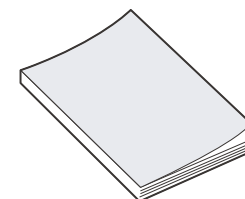

User's manual



Warranty Card

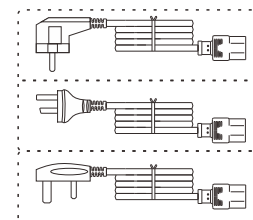

Euro Schuko plug power cord
 or AUS plug power cord
 or UK power cord

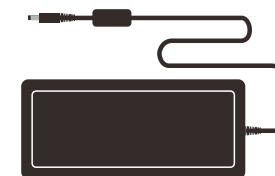

Adapter



Remote control base

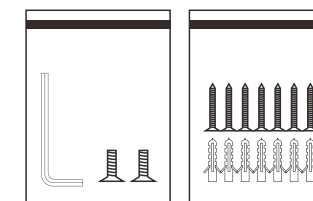

Fixed fittings

Content

SPECIFICATION	1
OVERVIEW	2-3
SUPPORTING SIGNALS	4
INSTALLATION	5-9
GENERAL DESCRIPTION	10
REMOTE-CONTROL UNIT	11
INITIAL SETUP	12-14
HOME SCREEN	15
INPUT SOURCE	15-16
CHANNELS & INPUTS	17
ANTENNA	17-21
DISPLAY & SOUND	22-23
NETWORK & INTERNET	24
ACCOUNTS & SIGN-IN	25
PRIVACY	26
APPS	27
SYSTEM	27-29
REMOTES & ACCESSORIES	30
TROUBLESHOOTING	32-34
WARRANTY POLICY	35-36

Specification

Model	BT24A1KEGB	BT32A1KEGB
Display Size	24"	32"
Display Screen Type	LED	
Power adaptor	DC 12V $\overline{\text{---}}$ 4A	DC 12V $\overline{\text{---}}$ 6A
The maximum resolution	1920 X 1080	
Power Consumption(Max)	30W	58W
Sound output(Max)	2 x 5W	
TV system	DVB-T2-S2	
Frequency range	48. 25MHz - 863. 25MHz	
Video input Format	PAL/NTSC	
Antenna input impedance	75 Ω (Unbalance)	
Product Dimensions (Include base bracket)	597 X 406.4 X 42mm	788.4 X 505.3 X 50.8 mm
Operation environment temperature	0°C-40°C	

Note:

Design and specification modification maybe made at any time without prior notice, all data and dimensions are approximations.

Overview

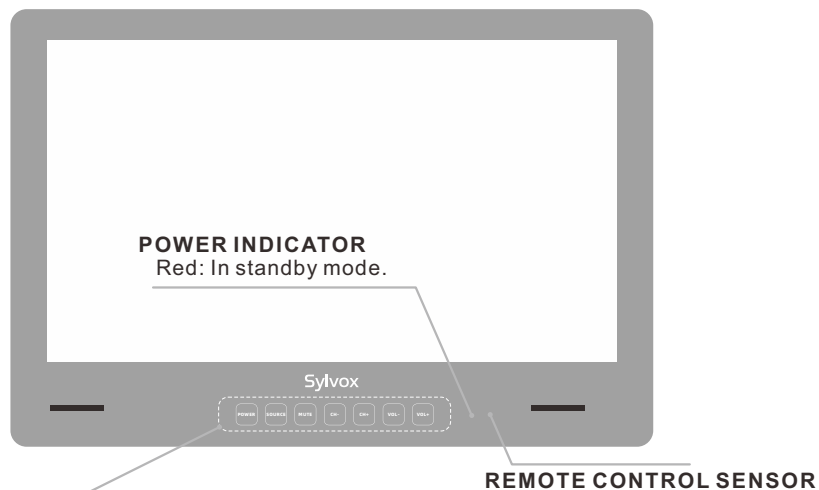

POWER: Press this button to turn the TV on or off.

SOURCE: Press to open the input source list.

MUTE: Press this button to cut off the sound of the TV set temporarily, press again to resume.

CH-/+: Press to change channels.
In the on-screen menu, use the CH +/- buttons as up/down arrow buttons.

VOL-/+: Press to increase or decrease the volume.
In the on-screen menu, use the VOL +/- buttons as left/right arrow buttons.

Overview

DVB-S2 & CI+ will not be available in Australia
CI+ will not be available in New Zealand

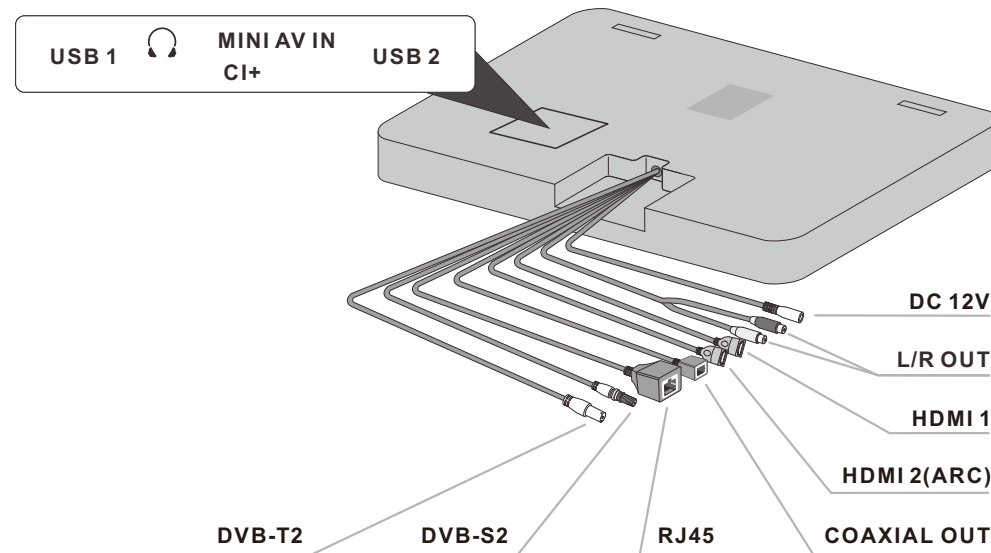

1. **USB1/2**
Connecting for USB signal.
2. **EARPHONE OUT**
Connecting for headphone.
3. **CI+**
Used to insert the CI card.
4. **MINI AV IN**
Connecting for VIDEO signal input in Composite mode.
5. **DVB-T2**
Connected to external antenna to receive the ATV/DTV program in ATV/DTV mode.
6. **DVB-S2**
Connected to external SATELLITE to receive.
7. **RJ45**
Ethernet connection for.
8. **COAXIAL OUT**
Coaxial Digital audio output.
9. **HDMI 2(ARC)**
Connecting for HDMI.
10. **HDMI 1**
Connecting for HDMI.
11. **L/R OUT**
Connect to the audio output jacks on your amplifier/home theater.
12. **DC 12V**

Supporting Signals

PRESET MODE (HDMI)

	Resolution	V.Freq.(Hz)	H.Freq.(KHz)
1	640x480	59.94	31.469
2	720x480	59.94	31.469
3	720x576p	50	31.25
4	800x600	60	37.9
5	1280x720p	60	45
6	1920x1080i	60	33.75
7	1920x1080p	60	67.5

Installation

Precautions during installation



Please install the TV host after the unit bus is installed. However, if the wall is difficult to process after installation, please process it before installation.

Please confirm the installation position of the TV main body, so as not to interfere with the wiring or faucet of the remote controller for hot water supply.

If there are ribs on the back of the wall, please avoid the ribs and adjust the position of the mounting holes.

When using the mounting bracket, please be careful not to be injured by the end face.

Matters needing attention when unpacking

The mounting bracket leaves the factory in the state of being mounted on the TV main body. When disassembling, please lift the bottom side, and then pull out the upper claw.

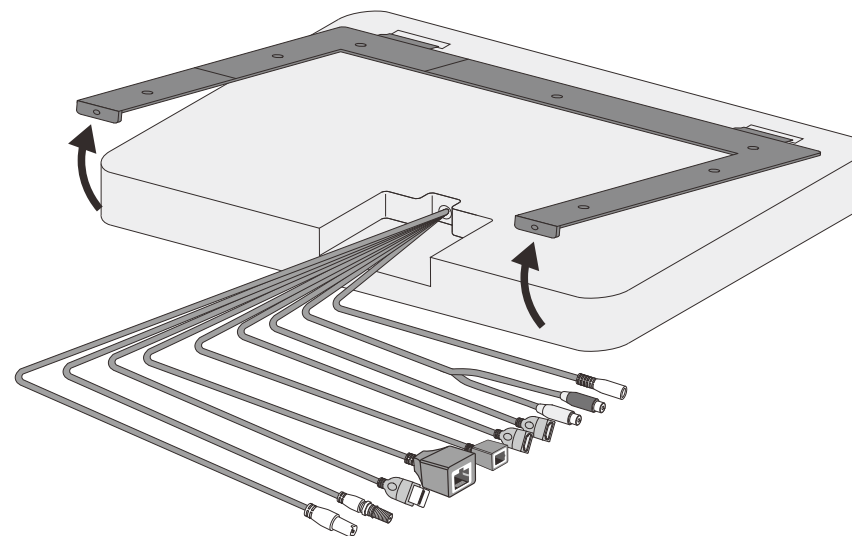

Mark the positions of wiring holes and screw holes.

- Place the installation fittings in the predetermined installation position of the bathroom wall.
 - ※. Please pay attention to the size difference between the mounting bracket and the TV main body.
 - ※. Please make sure that the wall at the scheduled installation location is flat.
- Draw a reticle on the bathroom wall according to the lines engraved on the mounting bracket.
- Mark the mounting hole position 7 of the mounting bracket.

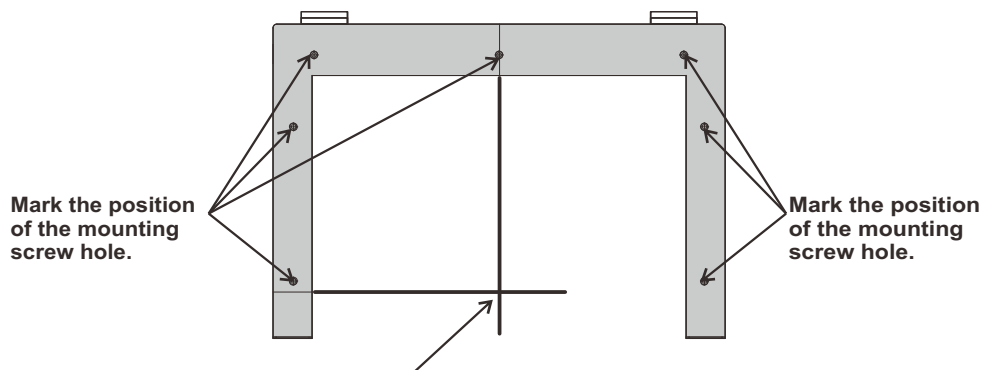

Draw a crosshair according to the reference line.



When sticking to the mounting bracket, please pay attention to whether it is horizontal.

Drill wiring holes in the bathroom wall

With the intersection point of the reticle drawn on the bathroom wall in step1 as the center, punch $\Phi 40\text{ mm} \sim \Phi 60\text{ mm}$.

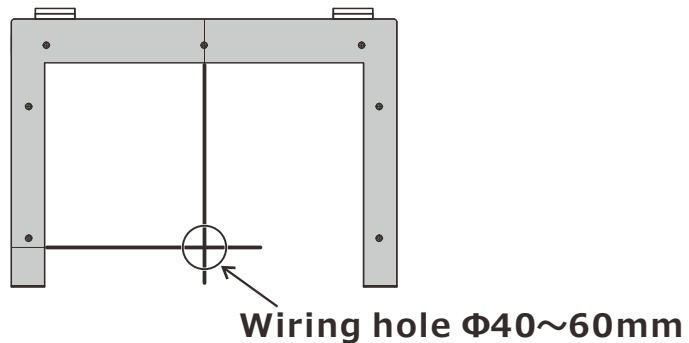

Installing support

Make a bottom hole at the place where the screw is driven.

Please use screws or fixers in the installation of metal parts according to the material, thickness and state of the installed bathroom wall.

Punch holes in the marked positions in step 1.

When using the attached screws, please make a pre-drilled hole based on $\Phi 3.0\text{mm}$.

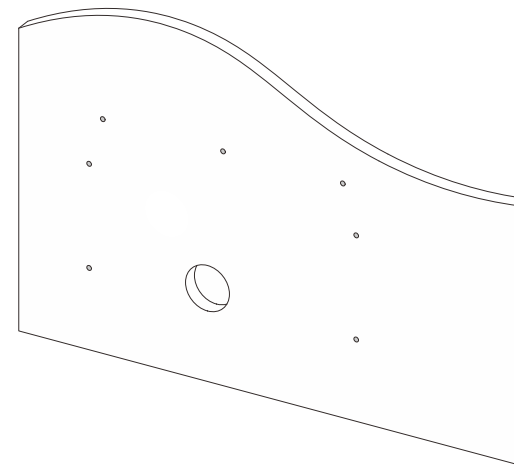

Make a bottom hole at the place where the screw is driven.

Drive the current threaded sleeve into the hole and fix it with the screw mounting bracket.

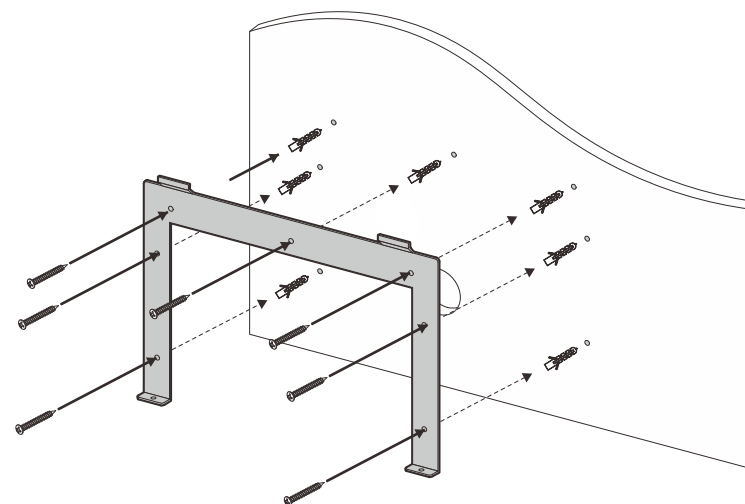

Please be careful not to let the screws damage the pipes in the wall.

Cable jumper

Lead out the cable from the wiring hole.

The cable is led out from the wiring hole for about 200~300mm.

※ Do not pull the cable hard. Otherwise, it will lead to disconnection.

Cable jumper

Connect with the cable on the back of the TV host.

After connection, please be sure to wrap self-fluxing tape around each connector and take waterproof measures.

※ Do not re-plug the cable when the power box is electrified. Otherwise, it will lead to failure.

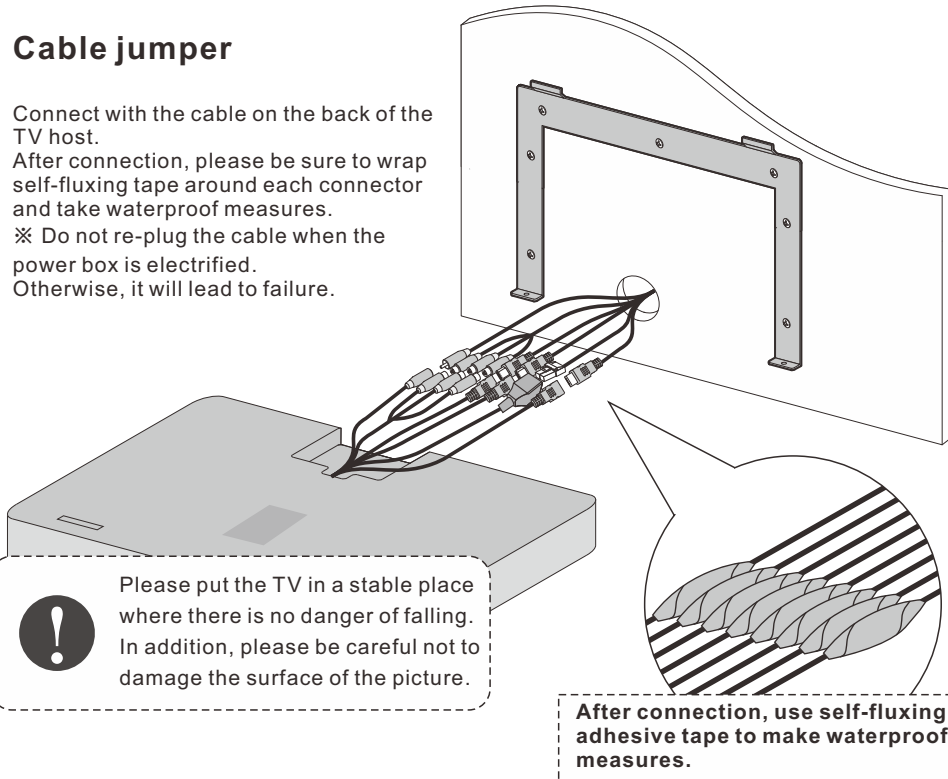

Temporarily set the TV main body Perform initial setting and action confirmation.

Install the TV main body on the installation fitting.

1. Align the slot of the TV main body with two claws on the upper part of the mounting bracket for installation.

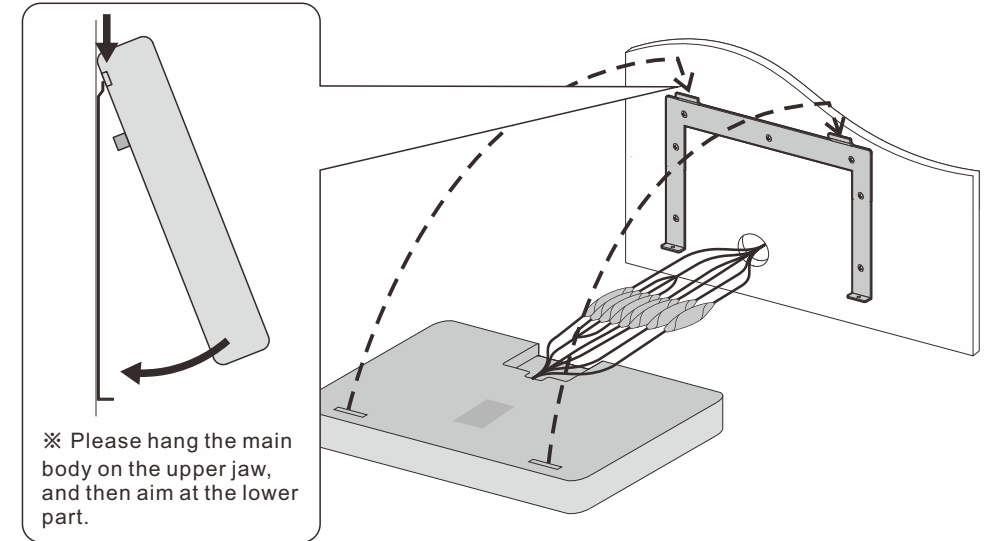

2. Fix the lower part of the mounting bracket at 2 places with screws.

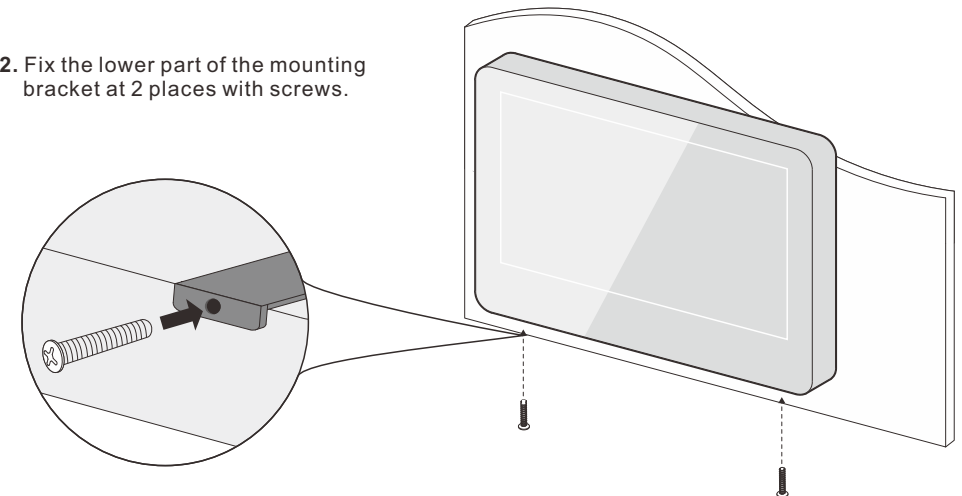

General Description

Installing Batteries

- 1 Use the accessory screwdriver to remove the four screws of the battery cover of the remote controller and open the battery cover.

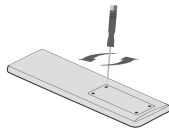

- 2 Insert two 1.5V AAA size batteries in correct polarity. Don't mix old or used batteries with new ones.

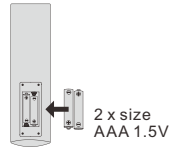

- 3 Lock the four screws on the battery box cover of the remote controller with a screwdriver. Please keep the screwdriver.

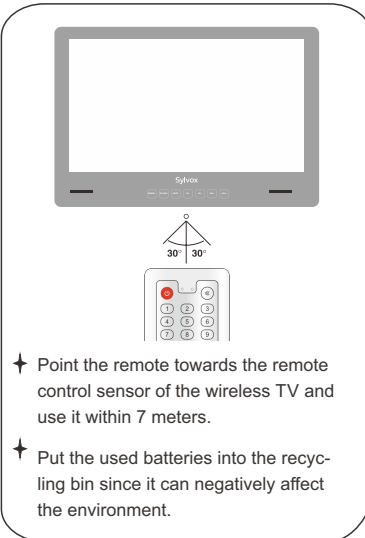
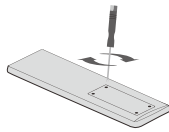

Note:

- 1) Batteries should last approximately one year under normal use (actual use will vary).
- 2) If the TV will remain inactive for an extended period of time, remove the batteries from the remote control to avoid possible damage due to leakage.
- 3) Do not mix old and new batteries or different types of batteries.
- 4) Do not throw batteries into fire or water.
- 5) The batteries (battery pack or batteries installed) should not be exposed to excessive heat such as sunshine, fire or the like.

Remote-Control unit

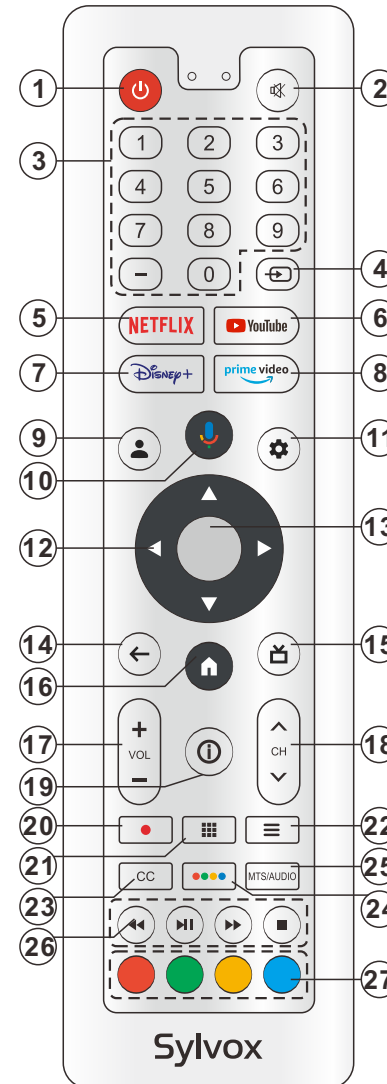

1. **POWER:** Turn the TV on and off.
2. **MUTE:** Press this button to cut off the sound of the TV set temporarily, press again to resume.
3. **Digital Buttons(0-9, -):** Directly select channel with digital buttons.
4. **INPUT:** Press to open the input source list.
5. **NETFLIX:** If network connects, press this key to view NETFLIX directly.
6. **YouTube:** If network connects, press this key to view YouTube.
7. **Disney+:** If network connects, press this key to view Disney+.
8. **Prime Video:** If network connects, press this key to view Prime Video.
9. **Profile:** Switch profile.
10. **Google Assistant:** Open Google Assistant.
11. **Settings:** Access the settings (direct or through the dashboard in GTV) from any place in the system.
12. **Arrow buttons ▲▼▶◀:** Use to select on-screen menu items and change menu values.
13. **OK:** Confirms selection.
14. **BACK:** Return to the previous menu.
15. **Guide:** Open Live TV EPG.
16. **HOME:** Display the HOME page.
17. **VOL +/- :** Press these buttons to adjust the volume.
18. **CHA/V:** Press these buttons to change channel upward or downward.
19. **INFO:** Press to display the channel information.
20. **● :** In DTV mode, press ● button to record the TV program.
21. **APPS:** Press to display the app list.
22. **LIST:** Press to display the channel list.
23. **CC:** Display CC function menu in TV/AV mode.
24. **Button:** Press to open virtual keyboard in DTV source.
25. **MTS/AUDIO:** In USB mode, press this button to switch audio track when movie is playing. In TV mode, press this button to switch MTS or Audio Language.
26. **DIGITAL MEDIA PLAYER CONTROL BUTTON:** Include backward, forward, play/pause, stop in USB mode.
27. **COLOR BUTTONS:** It's used in the APPS.

Initial Setup

1. Please connect the TV to the power supply, and the indicator light will be red after power-on. Press the (power) button on the remote control or TV to turn on the TV.
2. You need to pair the remote control with the TV first. After the code is successful, you can use the Operate the Bluetooth remote control of the TV.

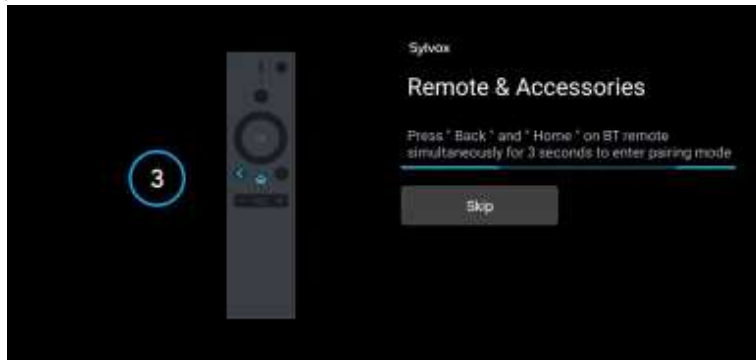

3. Press ▲/▼ to select the system language and press OK to confirm the language.

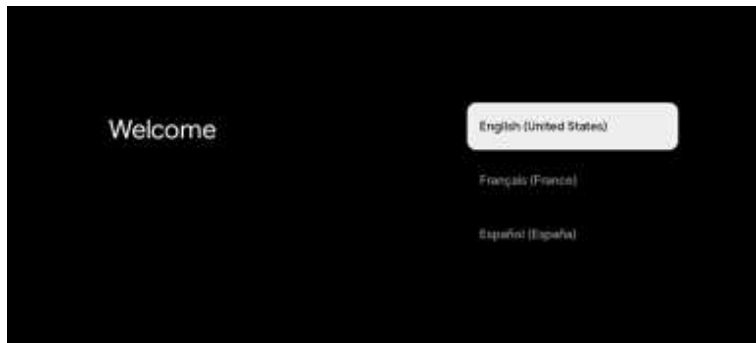

4. Press ▲/▼ to set up Google TV which need to sign in google account for Google service, or basic TV which not need to sign in google account.

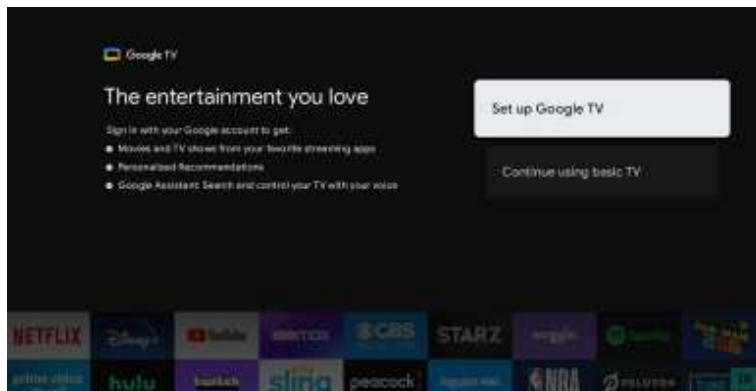

5. Scan setup code to download Google home app on your phone to set up or press ▲/▼ to set up on TV.

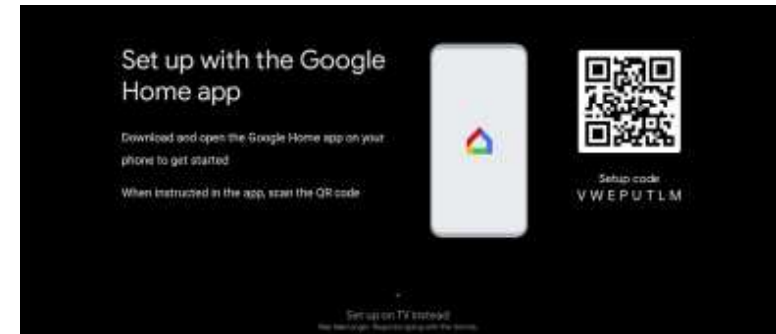

6. Press ▲/▼ to select the wifi to connect, press OK and enter the password to confirm the connection is successful.



7. By accepting the Google Terms of Service to improve the product experience, select "Accept" to accept this condition.

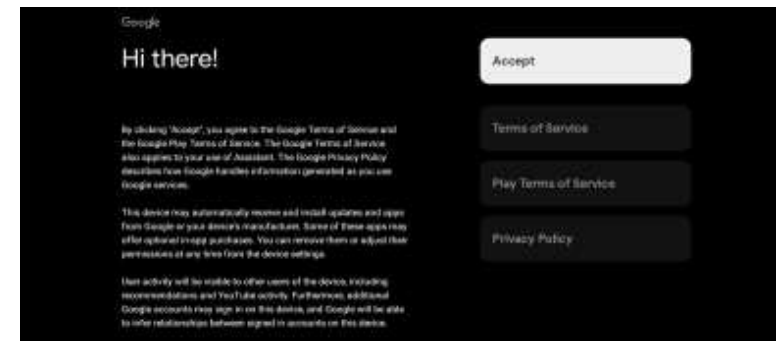

8. Set your location.

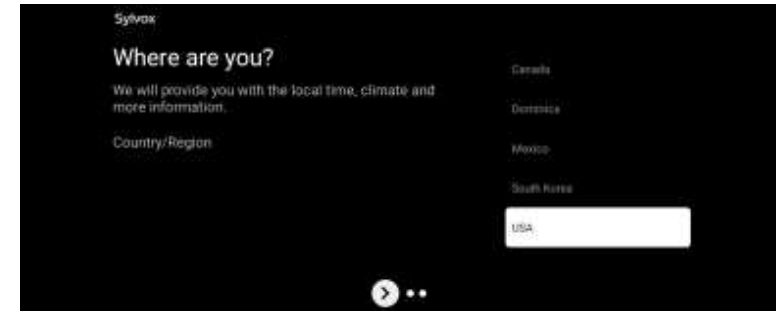

9. Set the Tuner mode, You can also choose to skip first.

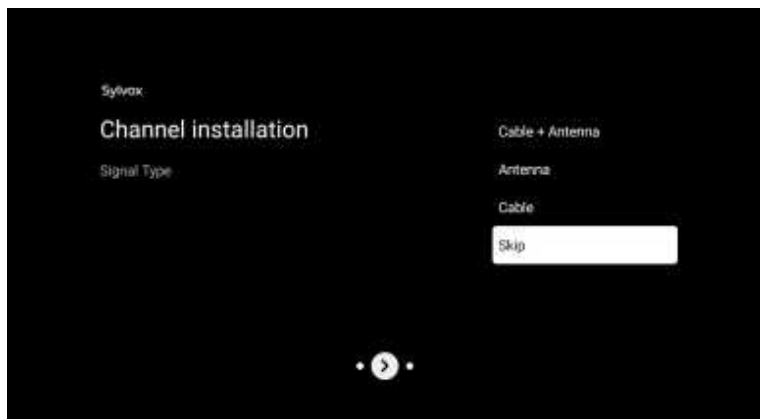

10. Please double check your Settings, After confirming OK, you can use it.

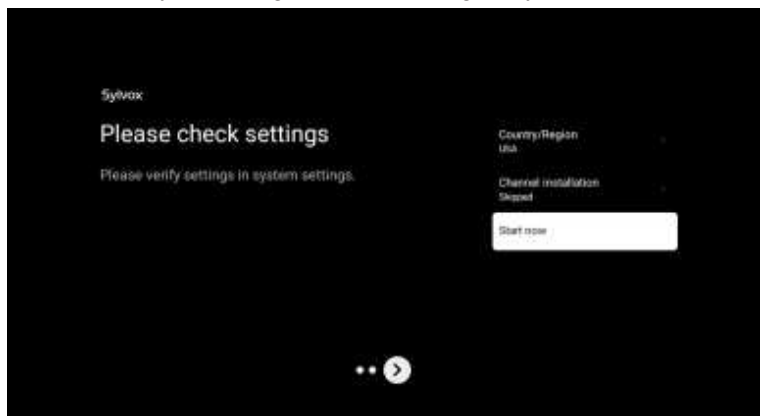

※ The content displayed in the image depends on your region.

HOME SCREEN

After completing the wizard Settings, you can watch TV and go to the home screen.

①

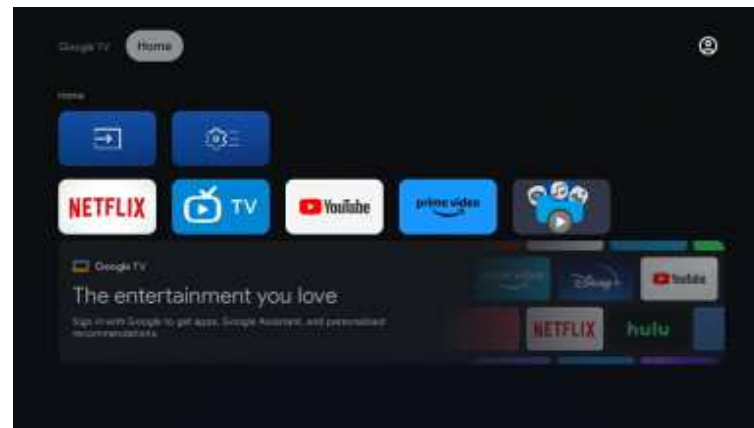

②

1. Open Google Assistant or start a text search.
2. Among the applications installed on the TV, the icons for the favourite applications are shown inside here. (Favourite applications can be added/ deleted/changed its order by users.)

📺 Inputs: Icon to select an input source.

⚙️ Settings: Various settings can be configured here. For details on the settings, see the next explanation.

INPUT SOURCE

In the HOME interface, press ▲/▼/◀/▶ to select the "Inputs" icon, press OK to open the input source list, then press up to highlight an input and press OK to switch.

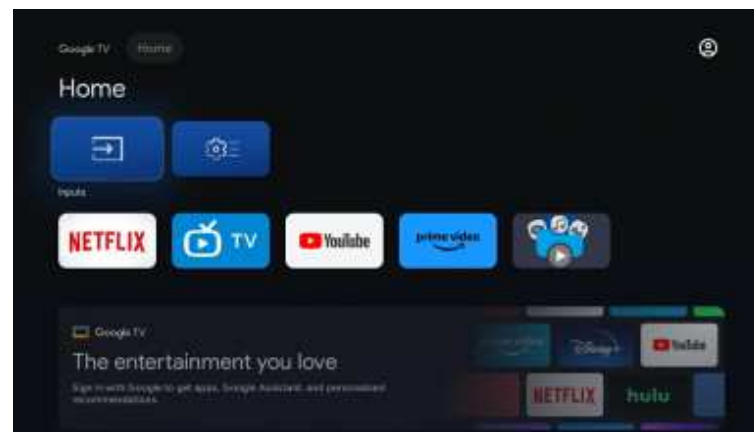



Under live TV, press the  button to display the list of input sources. You can select the desired source.

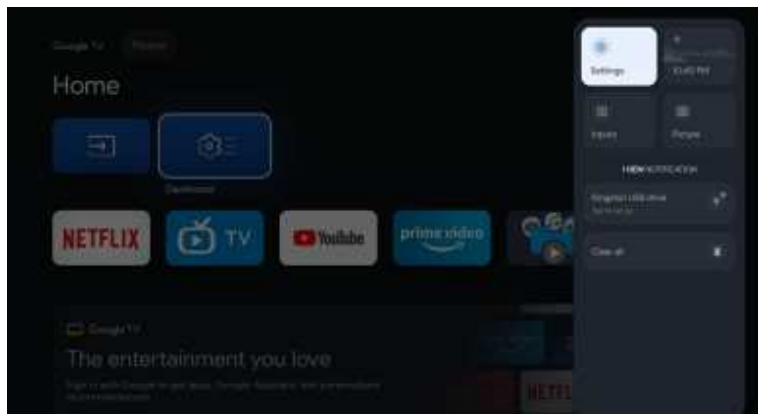

NAVIGATING THE ON-SCREEN MENU

1. In the HOME interface, press the  key to select the icon of the circular settings menu, press OK to confirm.



2. Press / button to select what you want set.
3. Press OK to enter setting.



Channels & Inputs

To set Channels and Inputs

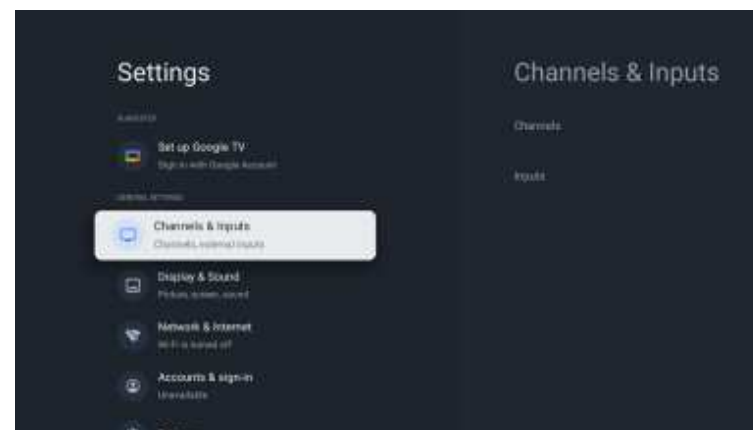

Add channels

To add for the first time or additional channels, please follow the steps below:

- 1 Go to Settings > Channels & Inputs > Channels
- 2 Select your signal type
- 3 Select Channel Scan to start channel installation.

Antenna

Press  on remote controller, and select ATV or Antenna to search TV channels.

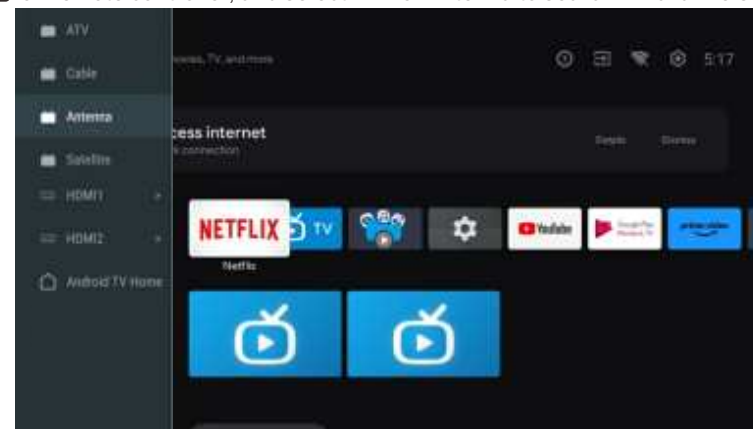

After entering into ATV page, then Auto Tuning and Manual Tuning are for optional Auto Tuning will search frequency automatically.

Choose Auto Tuning, and press confirm, then it searches TV channels automatically.

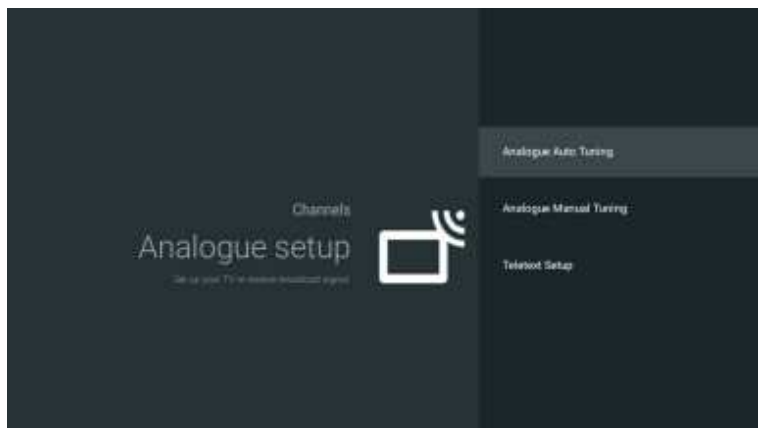

The TV channels will be ordered by TV automatically after the end of searching.

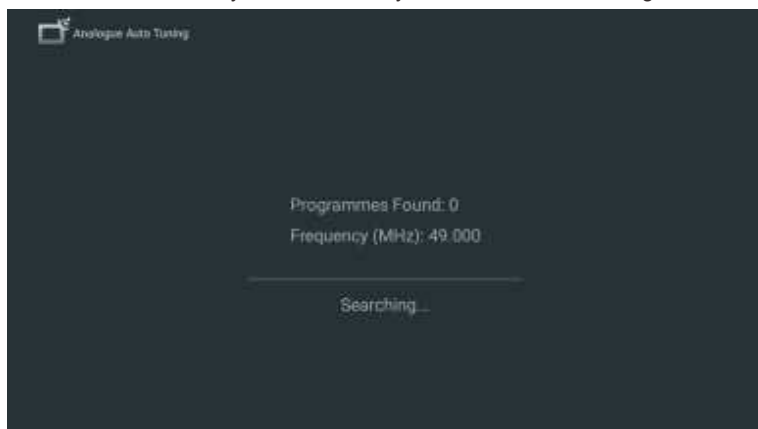

Searching frequency, audio system and color system can be revised by Manual Tuning.

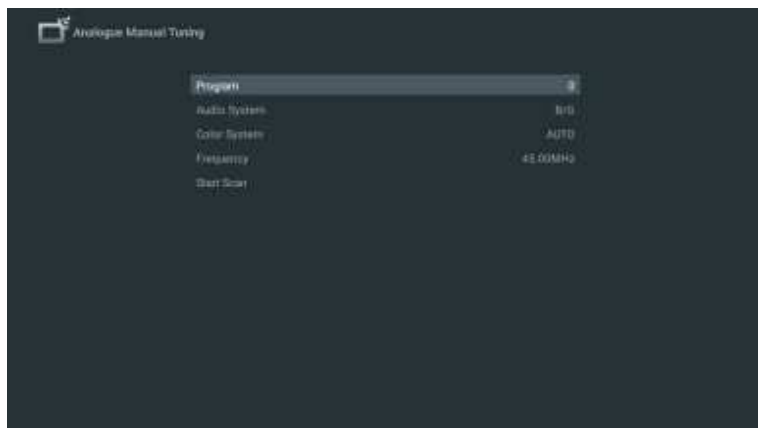

Antenna Tuning also can be divided as Auto Tune and Manual Tune. Set LCN as on, and the TV channels will be ordered automatically after searching. Automatic Channel Update: it's a function to update frequency automatically.

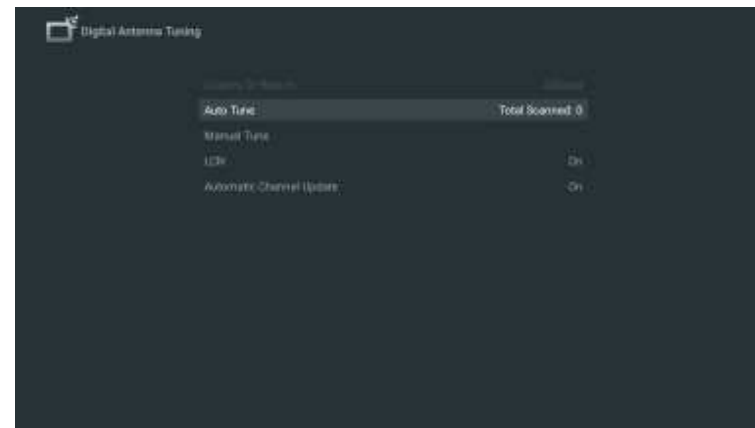

Click OK to choose Auto Tuning mode.



The TV channels will be ordered by TV automatically after the end of searching.

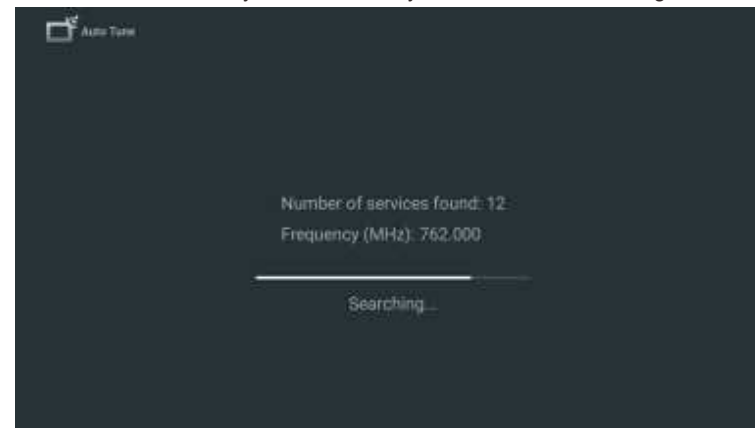

Press **↵** on remote controller, and select Satellite Tune to search TV channels.

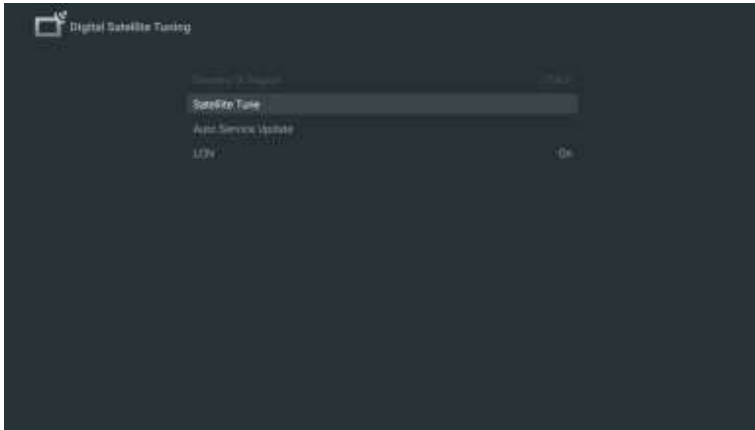

Set LCN as on, and the TV channels will be ordered automatically after searching.

Select Satellite

It's optional to delete Satellite, edit Satellite, and add Satellite, after confirm the TV will scan channels.



Edit Satellite



Adding Satellite

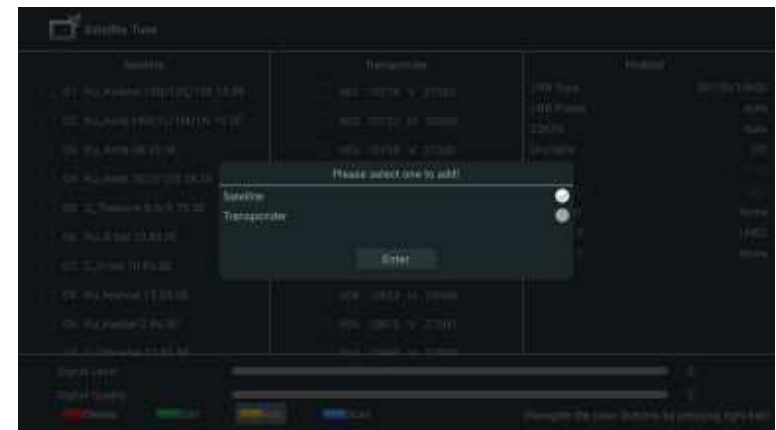

Press Scan to search Programmes.



The TV Programmes will be ordered by TV automatically after the end of searching.



Inputs

Consumer Electronic Control (CEC) - This allows you to operate the linked functions between our brand devices with CEC feature and this unit. We do not guarantee 100% interoperability with other brands of CEC compliant devices.

Display & Sound

To set Picture and Sound



Picture

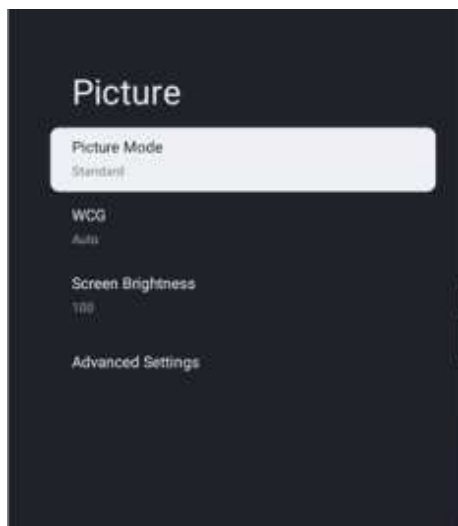

Picture Mode

Standard: For normal TV viewing.

Movie: Deep picture settings for a cinematic experience.

ECO: Eco TV settings for low power consumption.

Vivid: Enhanced picture contrast and sharpness for viewing in a well-lit room.

Sports: Brilliant picture settings for high action.

Game: Optimized for PCs and game consoles.

Screen Brightness

Adjusts the LED brightness to affect the overall brilliant color.

Advanced Settings

For more detailed picture settings, go to Advanced Settings, where you find settings for Color Temperature, Noise Reduction And Picture Reset etc.

Sound

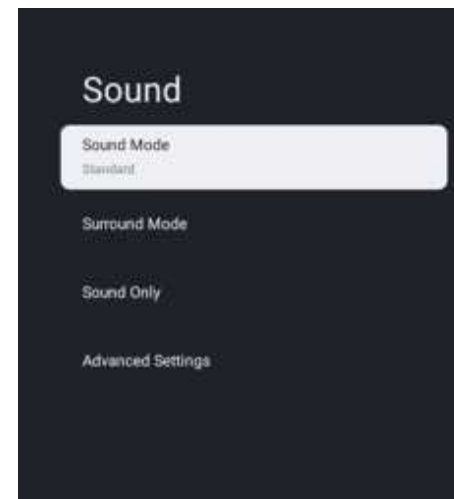

Sound Mode

The following sound settings can be configured. Depending on the format of the broadcasting, some sound settings are not available.

Standard: For normal TV viewing.

Movie: Powerful sound settings for a cinematic experience.

Music: Optimized for music playback.

News: Set the anchor's voice at a comfortable volume.

Personal: The customized settings you preferred.

Audio output

Output Device: TV Speaker/SPDIF/Optical/HDMI-ARC

Digital Output: Auto/Bypass/PCM/ Dolby Digital Plus/ Dolby Digital

Digital Output Delay

The on-screen picture and the sound from an amplifier via the digital audio (SPDIF) output jack are synchronized by delaying the output from the connection.

The higher values will increase the digital audio (SPDIF) output delay.

Network & Internet

Setup network connection settings in order to use apps or network upgrade functions. To set Network & Internet.



Wi-Fi setting

1. Confirm that Wi-Fi is turned on and you're connected to the correct network.
2. If not, locate the network you'd like to connect to and select it to connect. Enter the password if required.
3. Open one of your apps.
4. Play your video, music, or game again.

Note(s)

If you still have issues, turn the Wi-Fi option off and on again.

Use your Mobile/Tablet hotspot

Automatically adjusts video quality to use less mobile data.

- Data Saver reduces your data usage on mobile connections, increasing watch time by up to 3x.
- Data usage and alerts help you monitor your data usage while watching TV.

Scanning always available

Let Google's location service and other apps scan for networks, even when Wi-Fi is off.

Ethernet

Proxy settings: Set Proxy manually.

IP settings: Configure the IP setting for your network connection.

Accounts & sign-in

You can manage to add or remove your Google account and kids profile account.

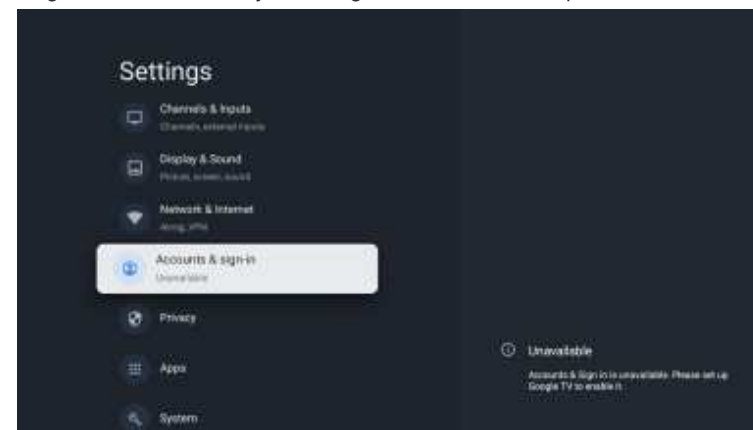

Google Account

Google TV profiles let everyone in your home enjoy their own personalized space with their Google Account. With a personalized profile, you'll get TV show and movie recommendations just for you, easy access to your personal watchlist and help from your Google Assistant.

Add Google account

You can add more than one account on your Google TV so you can sign in to services with multiple accounts. Your media and activity sync across devices that your Google Account is signed in to.

Add a Kid

Set up a kids profile on Google TV to choose which apps your kids can use, and to set up bedtime reminders and screen time limits.

* Kids profiles may not be available in some regions or on some devices.

Privacy

This section is privacy settings of your TV, Google account and applications.

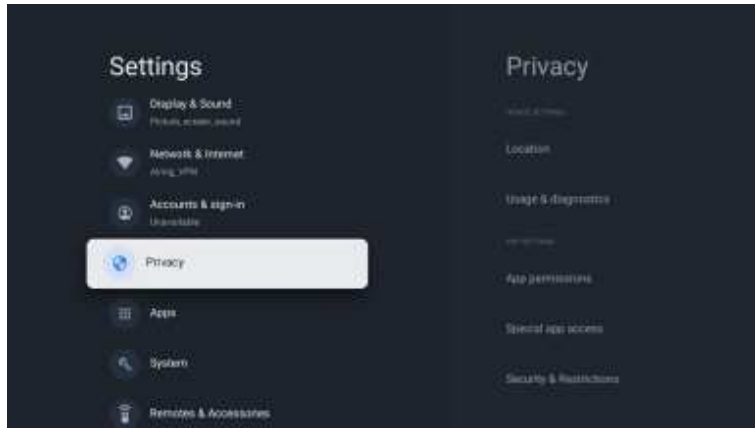

Location

- Google may collect location data periodically and use this data in an anonymous way to improve location accuracy and location-based services.

Usage & diagnostics

- Automatically send diagnostic information to Google, like crash reports and usage data from your device, apps, and Chromecast built-in. You can adjust these permissions at any time from device settings. Learn more at g.co/tv/diagnostics.

Ads

- Manage your ads settings, such as resetting your advertising ID.

Google Assistant

You can ask questions and complete tasks on your Google TV with Google Assistant. Google Assistant comes installed on your Google TV device. You can turn it on when you first set up your device, or you can turn it on later.

Payment & Purchases

- Manage your account and purchases through the Play Store app on your mobile device, or by following these links in a Web browser:
 - Payment methods g.co/ManageWallet
 - Order history g.co/Play/Order
 - Subscriptions g.co/Play/Subscriptions

Security & Restrictions

- Your device and personal data are more vulnerable to attack by apps from unknown sources. You agree that you are solely responsible for any damage to your device or loss of data that may result from using these apps.

Apps

This section is apps settings, such as checking details and permissions.

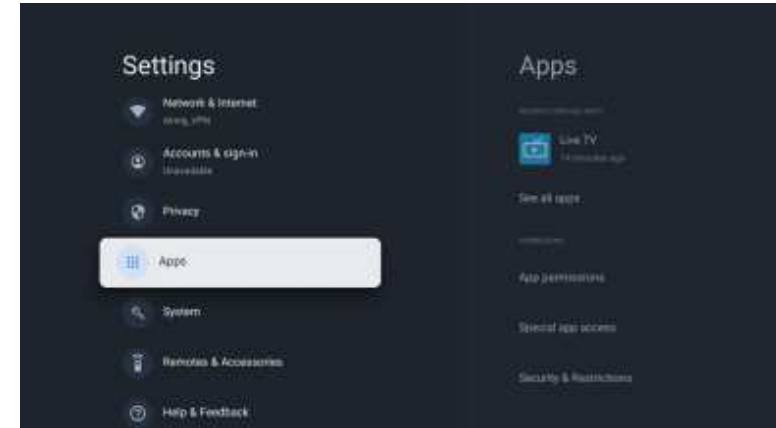

System

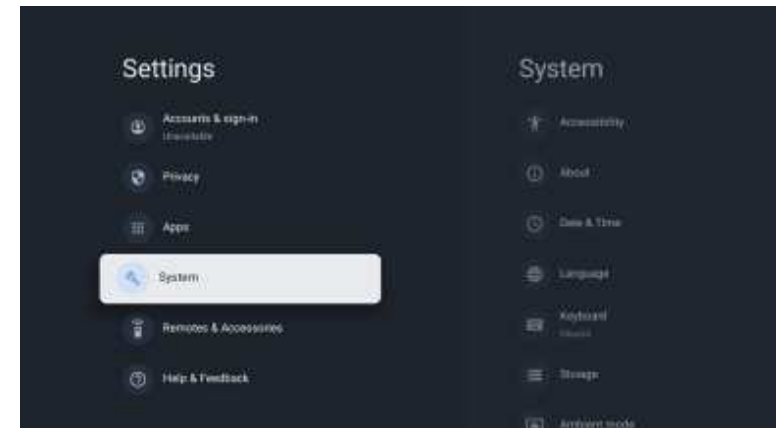

Accessibility

You can use a screen reader, closed captions, Switch Access, and more to make your Google TV device more accessible.

1. Press a (HOME) and use ▲▼◀▶ to select Settings then press OK.
2. Use ▲▼ to select System, then press OK.
3. Use ▲▼ to select Accessibility, then press OK.
4. Adjust the following items.

Turn on closed captions

Your caption preferences might not apply to certain apps.

1. From the Google TV home screen, in the top right, go to the user profile icon and select Settings.
2. Select System > Accessibility.
3. Select Captions.
4. Turn on Display to show captions. Then choose your options.

You can choose the size, font, color, background and other characteristics of the caption text.

Turn on high contrast text

1. From the Google TV home screen, in the top right, go to the user profile icon and select Settings.
2. Select System > Accessibility.
3. Turn on High contrast text (Experimental).

Text to speech

Text to speech output settings.

To set On/Off of this function, select and set TalkBack.

Use accessibility shortcuts

Accessibility shortcuts are a quick way to turn on accessibility features. To use accessibility shortcuts, you first need to turn them on.

To turn on accessibility shortcuts:

1. From the Google TV home screen, in the top right, go to the user profile icon and select Settings.
2. Select System > Accessibility.
3. Select Accessibility shortcut > Enable accessibility shortcut.
4. By default, the shortcut turns on TalkBack. To change what's included in the shortcut, choose Shortcut service.
5. Choose an option and select OK.

To use the shortcut: On your remote, press and hold the back arrow and down buttons at the same time for 3 seconds.

TalkBack

TalkBack is the Google screen reader included on Android devices. TalkBack gives you spoken feedback so that you can use your device without looking at the screen.

Change screen reader settings

1. From the Google TV home screen, scroll up to the top navigation bar.
2. Select Profile Settings > Dashboard > Settings.
3. Select System > Accessibility.
4. Under "Services," select TalkBack > Configuration.
5. Change settings for speech volume, verbosity (such as keyboard echo and usage hints), and spoken passwords.

Note(s)

To find more options and settings for TalkBack, such as speech rate and intonation, in the Accessibility menu, select Text to speech.

Use a screen reader

1. From the Google TV home screen, scroll up to the top navigation bar.
2. Select Profile Settings > Dashboard > Settings.
3. Select System > Accessibility.
4. Under "Services," select TalkBack > Enable > OK.

Turn on Switch Access

1. From the Google TV home screen, in the top right, go to the user profile icon and select Settings.
2. Select System > Accessibility.
3. Under "Services," select Switch Access > Enable > OK.

About

You can check system update and TV registration information.

Reset

This will restore your device to default settings and erase all data, accounts, files, and downloaded apps.

Date & Time

Automatic date & time

Use network-provided time or off

If it is set to off, please manually set the date and time.

Set time zone

Select your time zone

Use 24-hour format

Set the time to display in a 12 or 24-hour format

Language

You can set the language for the on-screen display.

1. Use ▲ ▼ to select Language, then press OK.
2. Use ▲ ▼ to select English (Canada), English (United States), Español or Français then press OK.

Keyboard

Perform the keyboard setting.

Storage

Internal shared storage

Removeable storage

Ambient mode (Digital Photo Frame)

Google TV lets you set your TV to scroll through Google Photos when you're not watching anything.

Power & Energy**Power on behavior**

Select the screen to start when powering on the TV.

Cast

Cast to Google TV

You can cast content from phones, tablets, or laptops to your Google TV.

Restart

It just makes the TV turn off and again on. Your all settings will be kept. If you want to delete all settings of the TV, please do factory reset. Settings > System > About > Reset > Factory reset

* This will restore your device to default settings and erase all data, accounts, files, and downloaded apps.

Remotes & Accessories

You can connect several Bluetooth devices, like headphones or game controllers, to your Google TV. You can only connect one audio device at a time.

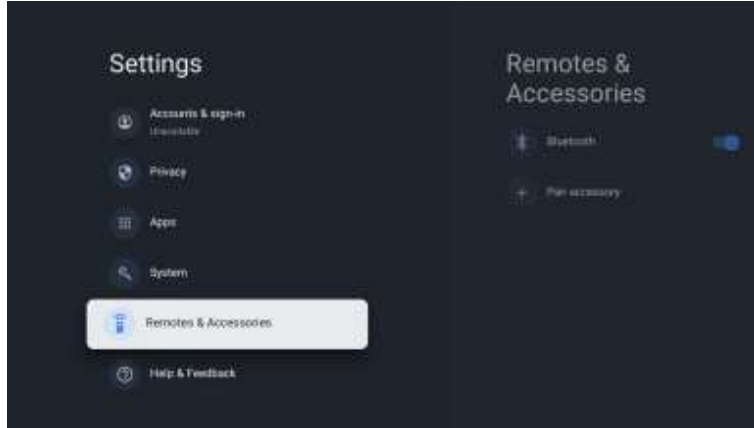

Pair a Bluetooth device

1. From the Google TV home screen, in the top right, go to the profile picture or initial and select Settings > Remote & Accessories > Pair accessory
2. Make sure your device is in pairing mode or is visible to other devices.
3. Identify the device you want to pair from the list and select it.
4. On the Bluetooth pairing request screen, select Pair.

Note(s)

Accessories that have been paired with your device appear in the Remote & Accessories section of Settings. You can also rename or forget devices.

Reconnect a paired device

1. From the Google TV home screen, in the top right, go to the profile icon and select Settings > Remote & Accessories
2. Under "ACCESSORIES" choose your device.
3. Select Connect.

Fix problems with connecting Bluetooth devices

If your Bluetooth device won't connect, it could be an issue with the Bluetooth device or your TV.

Troubleshoot connection issues

1. Turn off your Bluetooth device and then turn it back on. After your device is reset, try to pair it again.
2. If you have multiple devices paired with your TV, disconnect the ones you're not using.
3. Unplug your TV for 10 seconds and then plug it back in. When your TV is on, try to pair it again.
4. Check if your Bluetooth device connects to other devices, such as a phone or tablet.

- A. If your device connects to other devices: Reset your Google TV device to factory settings.
 B. If your device doesn't connect to other devices: Check that your Bluetooth device has up-to-date software or get help from the device's manufacturer.

Read Before Using Apps

(*Terms & Conditions Apply)

- Due to the product characteristics featured on the Apps store, as well as limitations in available content, certain featured applications, and services may not be available on all devices or in all territories. Some Apps featured may also require additional peripheral device or membership fees. Services and content availability are subject to change without prior notice.
- Manufacture takes no legal responsibility whatsoever for any interruption of App services caused by the service provider for any reason.
- An unstable Internet connection may cause delays or interruptions. In addition, applications may terminate automatically depending on the network environment.
- Applications services and updates may become unavailable.
- Application content is subject to change by the services provider without prior notice.
- Specific services may differ with the version of the application installed on the TV.
- An application's functionality may change in future version of the application.
- Depending on the third party service provider/s policies, certain applications may not support multitasking.
- The response to remote commands and the resulting on screen display may be delayed while a webpage is loading.
- The copy and paste operations are not supported.
- The web browsing speed will differs with the network environment.
- Depending on the types of video/audio codecs supported, it might not be possible to play certain video and audio files while playing content.
- Apps store have certain limitation, it consist many inbuilt apps for various needs of user but user doesn't have facility to add other apps from any other media.

Troubleshooting

If you have any problem, check the counter measures for each symptom listed below. The following symptoms may have been caused by inappropriate adjustment rather than actual malfunction of the unit. If the trouble persists, contact the Customer Care Centre, see back page for contact details.

Symptoms	Possible solutions
No power	Please check the power cord plugged in and that the power outlet works. Unplug the power cord and plug it in after 60 seconds and restart the TV.
No picture	Please check antenna connection. Station may be experiencing problems, please tune to another station. Please adjust the settings of contrast and brightness.
Good picture but no sound	Please increase the volume. Please check TV is under mute mode, press MUTE button on the remote control. Please check sound settings. If external devices are being used, check their volumes are not set too low or turned off. If using AVI or Component inputs, please make sure cables are connected properly and not loose. If using DVI to HDMI cable, a separate audio cable is required. Make sure a headphone jack >s not connected.
Good sound but abnormal color or no picture	Please check antenna connection and antenna condition. If using Component input, please check Component connections, incorrect or loose connections may cause colour problems or cause the screen to be blank.
No response to remote control	Batteries of remote control may have exhausted, if necessary, please change the batteries. Clean the remote control lens. The distance between LED TV and remote control should be within 8m, within recommended operating angle and path is free of obstructions.
Colored dots may be present on the screen	Although the LED screen is made with high-precision technology and 99.99% or more of the pixels are effective, black dots may appear or bright points of light (red, blue, or green) may appear constantly on the LED screen. This is a structural property of the LED screen and not a malfunction.
Picture is breaking up	Keep the TV away from noisy electrical sources such as cars, hair dryers, welders, and all optional equipment. Electrical atmospheric interference such as local or distant lightning storms may cause picture to break up. When installing optional equipment, leave some space between the optional equipment and the TV. Check the antenna and connection. Keep the antenna away from any power or input/output cables.

Symptoms	Possible solutions
After Auto Tuning only some channels are available	Check your area is covered by Digital Video Broadcasts. Try re-tuning or manually tuning missing channels. Check that you are using the correct antenna type.
Channel cannot be selected	Check if the channel has been blocked in the main menu settings. Please check connecting USB cable and power supply is connected. Hard drive has not been formatted. Please make sure USB disk is compatible and the multimedia data formats are supported. Only support FAT32 format for the USB disk.
USB not playing	Compression of video contents may cause distortion especially on fast moving pictures such as sports and action movies.
Picture is distorted, macroblock, small block, dots, pixelization, etc	Check cable connections, make sure a video cable is not connected to an audio input. Low signal level may cause sound distortion.
Noise from speaker	Check if the Off Timer is set to On in the Setup menu. Sleep Timer may have been enabled. If there is no signal for about 10 minutes from an input, the TV will turn off.
TV turns off automatically	Check if the On Timer is set to On in the Setup menu.
TV turns on automatically	Black bars on each side will be shown on HD channels when displaying SD (4:3) contents. Black bars on Top & Bottom will be shown on movies that have aspect ratios different from your TV. Adjust picture size option on your external device or TV to full screen.
Picture is not shown in full screen	

WARNING

Never place a television set in an unstable location. A television set may fall, causing serious personal injury or death. Many injuries, particularly to children, can be avoided by taking simple precautions such as:

- Using cabinets or stands recommended by the manufacturer of the television set.
 - Only using furniture that can safely support the television set.
 - Ensuring the television set is not overhanging the edge of the supporting furniture.
 - Not placing the television set on tall furniture (for example, cupboards or bookcases) without anchoring both the furniture and the television set to a suitable support.
 - Not placing the television set on cloth or other materials that may be located between the television set and supporting furniture.
 - Educating children about the dangers of climbing on furniture to reach the television set or its controls
- If your existing television set is being retained and relocated, the same considerations as above should be applied.

The plug or appliance coupler is used as the disconnect device, the disconnect device shall remain readily operable.

THE DISPOSAL OF ELECTRICAL AND ELECTRONIC EQUIPMENT WASTE PRODUCTS ON THE PART OF FINAL USERS IN THE EUROPEAN UNION

This symbol on the product or on the container indicates that this product cannot be eliminated with the general waste. The user is responsible for eliminating this kind of waste by throwing them away at a "recycling point" specifically for electrical and electronic waste. Selective collection and electrical equipment recycling contribute to preserve natural resources and warrant waste recycling to protect environment and health. In order to receive further information about electrical and electronic waste collecting and recycling, contact your Local Council, the service of household waste or the establishment where the product was acquired.

The crossed out "wheeled bin" symbol on the product reminds you of your obligation, that when you dispose of the appliance, it must be separately collected.



Warranty

Thank you for purchasing this Sylvox product.
If you have any questions, please contact us via our after-sales email or website for assistance.

After-sales email:

service.eu@sylvoxtv.com
service.uk@sylvoxtv.com
service.au@sylvoxtv.com

Website:

www.sylvoxtv.eu

Customer Service Support:

Service Hotline-USA: +1(866)979-5869 (Monday-Friday,9:00AM-5:00PM EST)

Warranty Policy

(1) When returning an item, please note the following:

1. Only items purchased directly from www.sylvoxtv.eu and authorized resellers can be returned, such as Amazon, Walmart, Newegg, Wayfair, Aliexpress, etc.
2. We will not accept any return requests for products purchased from unauthorized third-party suppliers.
3. Customer must contact the original vendor with your order ID or purchase proof and the detail of the product issue at Sylvox-Team to request a return/refund/repair/replace before returning products. Sylvox will provide you with the shipping label in the mail.
4. Sylvox are responsible for all return shipping costs for quality problem.
5. If there is no reason to return the product after installation and use, Sylvox shall have the right to charge restocking fees of 20% of the product value. (Only accept applications for no reason return within 7 days after arrival, and freight costs are the responsibility of the customer)
6. Ensure that the item(s) you are returning is repackaged in the original condition with all the documentation and accessories that came with it.
7. If the returned product is not in original packaging: artificial damage causes to affect the second sale, such as its appearance being damaged, the lack of accessories, etc., we will deduct the corresponding expenses according to the situation.
8. We will handle your request once getting your returning item.

(2) How to return a product for a refund? (30 days money-back guarantee)

To return an item to Sylvox, Please contact the Sylvox-team to submit an after-sales application, we will provide you with the shipping label in the mail.
Please include your original order number or order proof in the email and ensure that the item is returned within 30 days. No refunds will be issued until the item is received in its original packaging (with its documentation and accessories).

(3) Refunds

Once we receive and verify the condition of your product, a refund is initiated. The way your refund is processed depends on your original payment method.
For credit or debit cards, refunds will be back to the card-issuing bank within 7-10 business days of receipt of the returned item. Please contact the card-issuing bank with questions about when the credit will be posted to your account.

(4) What does the warranty not cover?

- (a) The wrong way of use and improper repair by the user caused the failure or damage.
- (b) Failure or damage caused by transportation, moving, and falling after purchase.
- (c) Other unavoidable external factors cause failure and damage.
- (d) Improper use of the equipment caused by water or other solution of damage.
- (e) Failure caused by a lightning strike or other electric system reasons
- (f) Damage caused by using power supply other than specified voltage.

Warranty Period:

- * Sylvox repairs the TV free of charge under the condition of the normal use of the instruction manual within 24 months.
- * Sylvox warrants that this product conforms to the manufacturer's specifications and will be free of defects in material and workmanship should any defect occur.
- * Sylvox will correct the defect subject to the following conditions:
 - (a) Any defects caused or repairs required as a result of the abusive operation, negligence, accident, shipment damages, improper delivery and installation, application, and use for which this product was not intended as set forth in the user's manual or other applicable Product documentation.
 - (b) Any defects caused or repairs required as a result of any product that has been tampered with, modified, adjusted, or repaired by any person other than Sylvox, a Sylvox authorized service provider or a Sylvox authorized service center or dealer.
 - (c) Any replacement of accessories, glassware, consumable or peripheral items required through normal use of the Product, including but not limited to, earphones, remote controls, batteries, etc.
 - (d) Any cosmetic damage to the Product surface or exterior, including but not limited to that which has been defaced or caused through normal wear and tear, improper shipping and handling, or the use of chemical cleaning agents.
 - (e) Any defects caused or repairs required as a result of damage caused by any external or environmental conditions, including but not limited to, the use of incorrect voltage, fluctuations or surges in transmission line/power line voltage, liquid spillage, or acts of nature or God.
 - (f) Warranty claims for Products returned with the altered, illegible, or missing model, factory serial number, and UL markings.
 - (g) Any Products used for rental, business, or commercial purposes.
 - (h) Any installation, consumer instruction, delivery, setup, adjustment, and/or programming charges.
 - (i) A Product that is not installed following installation instructions is included with the Product.
 - (j) Any signal reception problems (including antenna-related problems), images "burnt" into the screen, signal noise or echo, interference or other signal transmission or delivery problems, availability of third-party provided services or content (including, without limitation, image, audio or video content).

No other entity other than Sylvox is authorized to extend, enlarge or transfer this warranty on behalf of Sylvox.

The express warranties in this limited warranty are, in lieu of and, except to the extent prohibited by applicable law, Sylvox disclaims all other warranties and conditions, express or implied, whether arising by law, statute, by course of dealing, or usage of trade, including, without limitation, implied warranties or conditions of all claims, whether based in contract, negligence, strict liability or otherwise. Some states do not allow the exclusion or limitation of incidental or consequential damages, so the above limitation or exclusion may not apply to you.

For any questions, feel free to contact us via service.eu@sylvoxtv.com at any time!
service.uk@sylvoxtv.com
service.au@sylvoxtv.com

Sylvox

Badezimmer TV



**Hinweis: Reservieren Sie die Montageöffnung
(siehe Seite 48 für Details)**

Hinweis: Das Produkt und die Abbildungen in diesem Benutzerhandbuch dienen nur zur Erläuterung und können je nach Modell variieren.