

SUPERSEDES: August 16, 2021

EFFECTIVE: December 21, 2021

Plant ID No. 001-5021

DESCRIPTION:

The 0034ePlus is a high performance, variable speed, high-efficiency, wet-rotor circulator with an ECM, permanent magnet motor and an advanced digital LED display controller for easy programming and diagnostic feedback. With 5 operating modes and simple keypad programming, its variable speed performance curves are equivalent to the Taco 009, 0010, 0011, 0012, 0012 3-Speed, 0013, 0013 3-Speed & 0014. Ideal for large residential and light commercial hydronic heating, chilled water cooling and domestic hot water systems. The 0034ePlus reduces power consumption by up to 85% compared to equivalent AC permanent split capacitor circulators.

APPLICATION:

- Maximum operating pressure: 150 psi (10.3 bar)
- Minimum NPSHR: 18 psi at 203°F (95°C)
- Maximum fluid temperature: 230°F (110°C)
- Minimum fluid temperature: 14°F (-10°C)
- Electrical specifications:
 - Voltage: 115/208/230V, 50/60 Hz, single phase
 - Maximum operating power: 170W
 - Maximum amp rating: 1.48 (115V) / .70 (230V)
- Equipped with a cast iron or stainless steel casing
- SS Model suitable for open loop potable water systems
- Taco circulator pumps are for indoor use only – employer uniquement à l'intérieur
- Acceptable for use with water or maximum of 50% water/glycol solution

FEATURES:

- Simple keypad programming
- Digital LED screen display (Watts, GPM, Head, RPM and diagnostic error codes)
- Five operating modes to match any system requirements - activeADAPT®, Constant Pressure, Proportional Pressure, Variable Fixed Speed or 0-10V DC input
- Replaces all single speed and 3-speed circulators in its class
- ECM performance equivalent to Taco's 009, 0010, 0011, 0012, 0013 & 0014 circulators
- Multi-color LED display showing power on, mode setting and error code diagnostics
- Use with a Taco ZVC Zone Valve Control or SR Switching Relay for ON/OFF operation
- Nut-capture feature on flanges for easier fit up
- Dual electrical knockouts and removable quick-connect terminal strip for easy wiring
- Whisper quiet operation
- **BIO Barrier®** protects the pump from system contaminants
- **SureStart®** automatic unblocking and air purging mode
- Rotatable control cover to allow any pump body orientation

INSTALLATION:

WARNING: Do not use in swimming pool or spa areas. Pump has not been investigated for these applications.
AVERTISSEMENT : Ne pas utiliser dans une piscine ou un spa. La pompe n'a pas été étudiée pour ces applications.

CAUTION: The addition of petroleum based fluids or certain chemical additives to systems using TACO equipment voids the warranty. Consult factory for fluid compatibility.

ATTENTION : L'ajout de liquides à base de pétrole ou de certains additifs chimiques à des systèmes utilisant un équipement TACO annule la garantie. Consultez le fabricant pour connaître la compatibilité de liquides.

CAUTION: Installations at elevations over 5000 feet must have higher fill pressure of 20 psi minimum to prevent pump cavitation and flashing. Premature failure may result. Adjust expansion tank pressure to equal fill pressure. A larger size expansion tank may be required.

ATTENTION : Des installations à des altitudes de plus de 1600 mètres doivent présenter une pression de remplissage plus élevée de 20 psi au minimum afin d'éviter toute cavitation ou flashing de la pompe. Une défaillance prématurée peut en résulter. Réglez la pression du réservoir d'expansion de façon qu'elle soit égale à la pression de remplissage. Un réservoir d'expansion d'une taille supérieure peut être nécessaire.

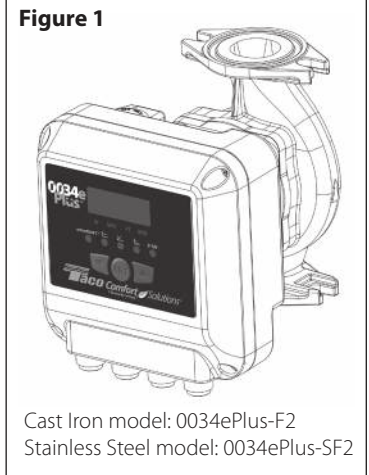
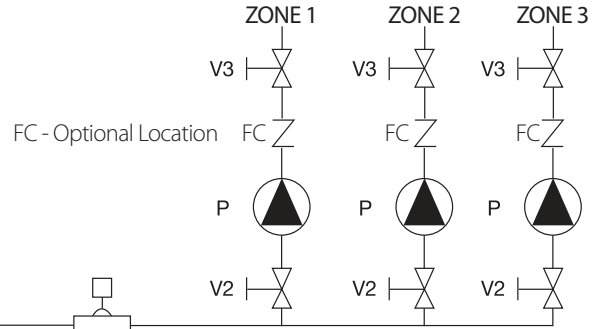
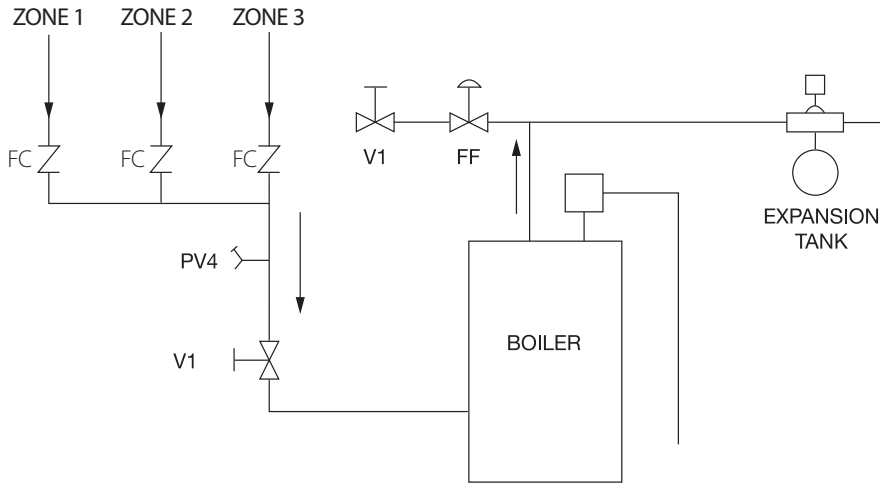
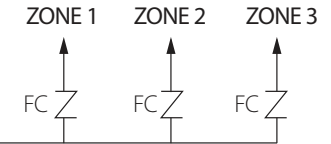
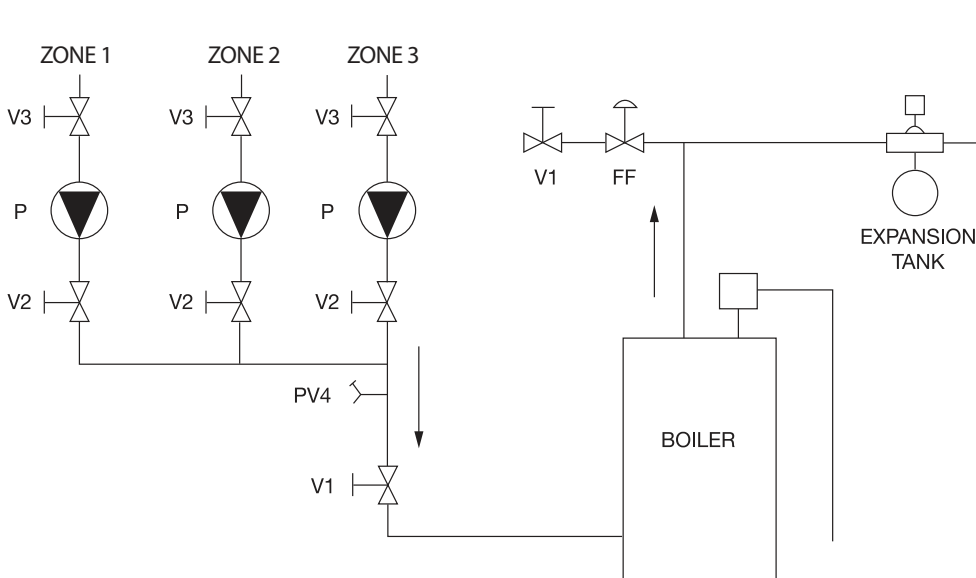

Figure 2

PREFERRED PIPING FOR CIRCULATORS ON BOILER SUPPLY



PREFERRED PIPING FOR CIRCULATORS ON BOILER RETURN



PREFERRED PRIMARY / SECONDARY PIPING FOR CIRCULATORS ON BOILER SUPPLY

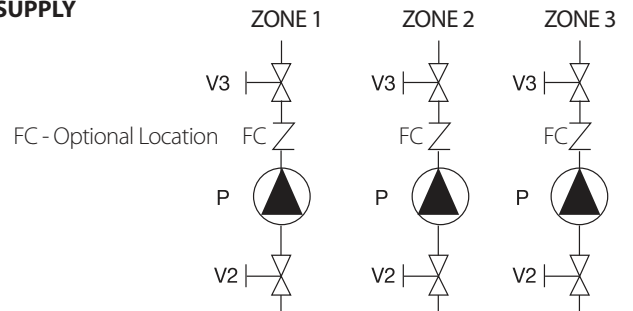
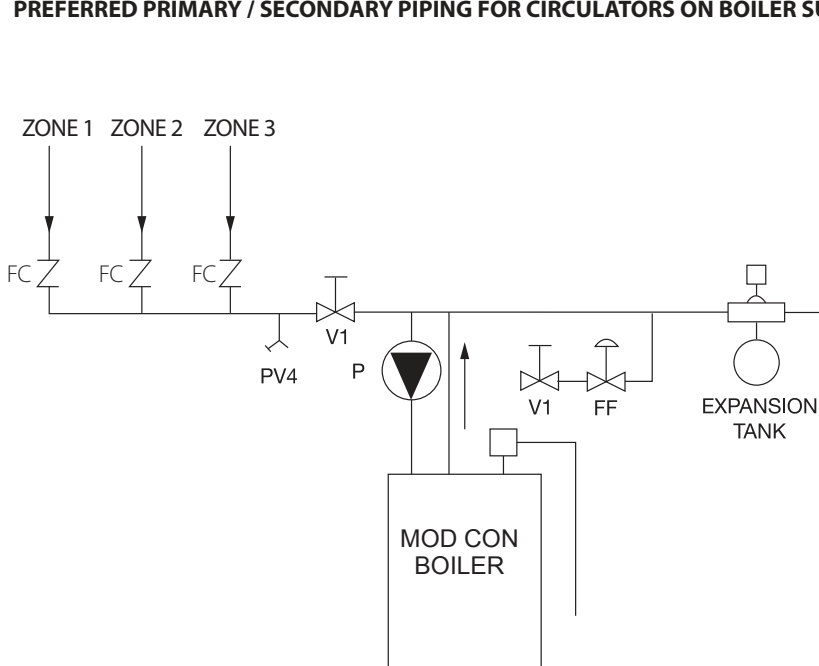

KEY:
 V1, V2, V3 = SHUT-OFF ISOLATION VALVE
 P = TACO 0034ePLUS CIRCULATOR
 FF = FAST FILL BOILER FEED VALVE
 PV4 = PURGE VALVE
 FC = FLOW CHECK VALVE

Figure 3

PREFERRED PIPING FOR ZONE VALVES ON BOILER SUPPLY

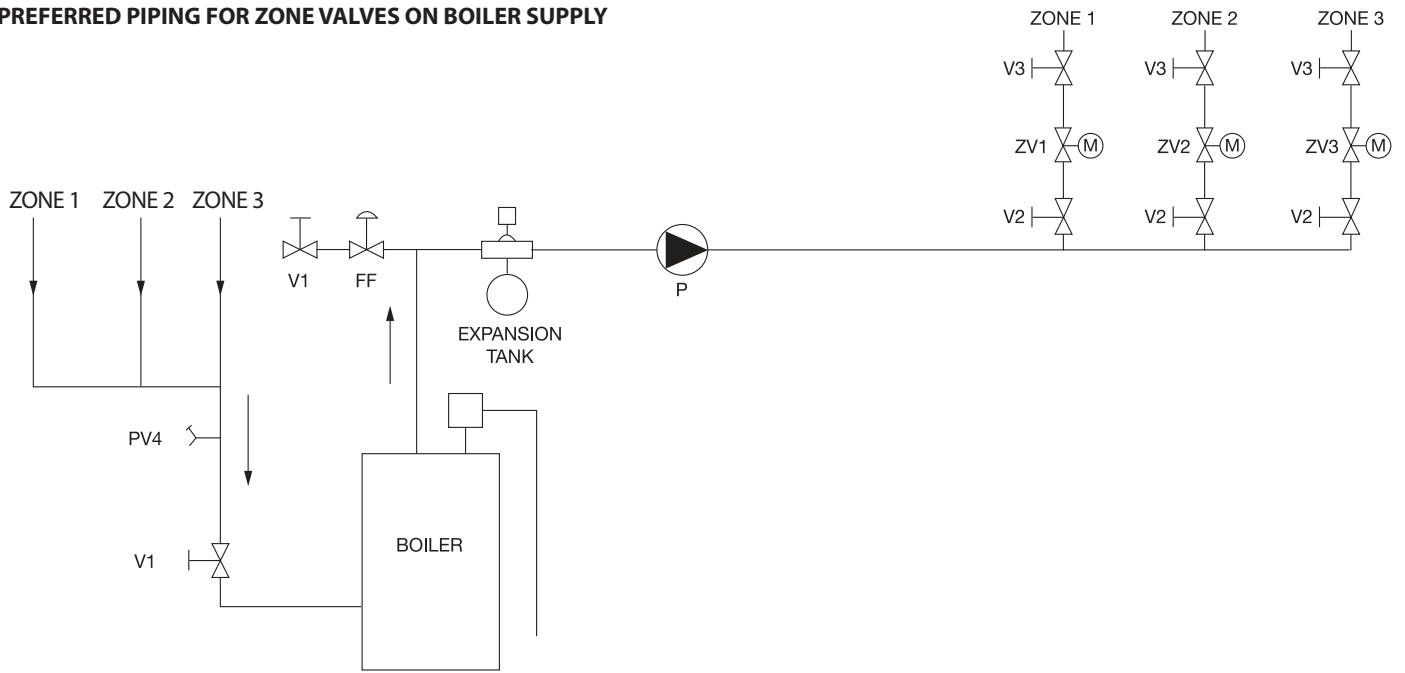

ALTERNATE PIPING FOR ZONE VALVES ON BOILER RETURN

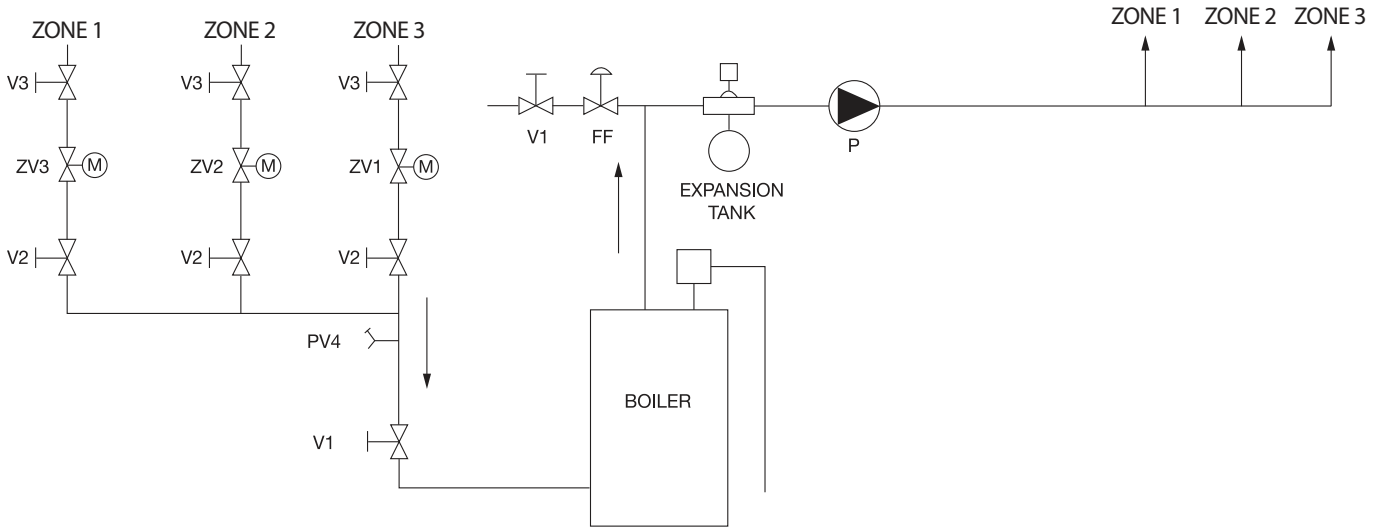

PREFERRED PRIMARY / SECONDARY PIPING FOR ZONE VALVES ON BOILER SUPPLY

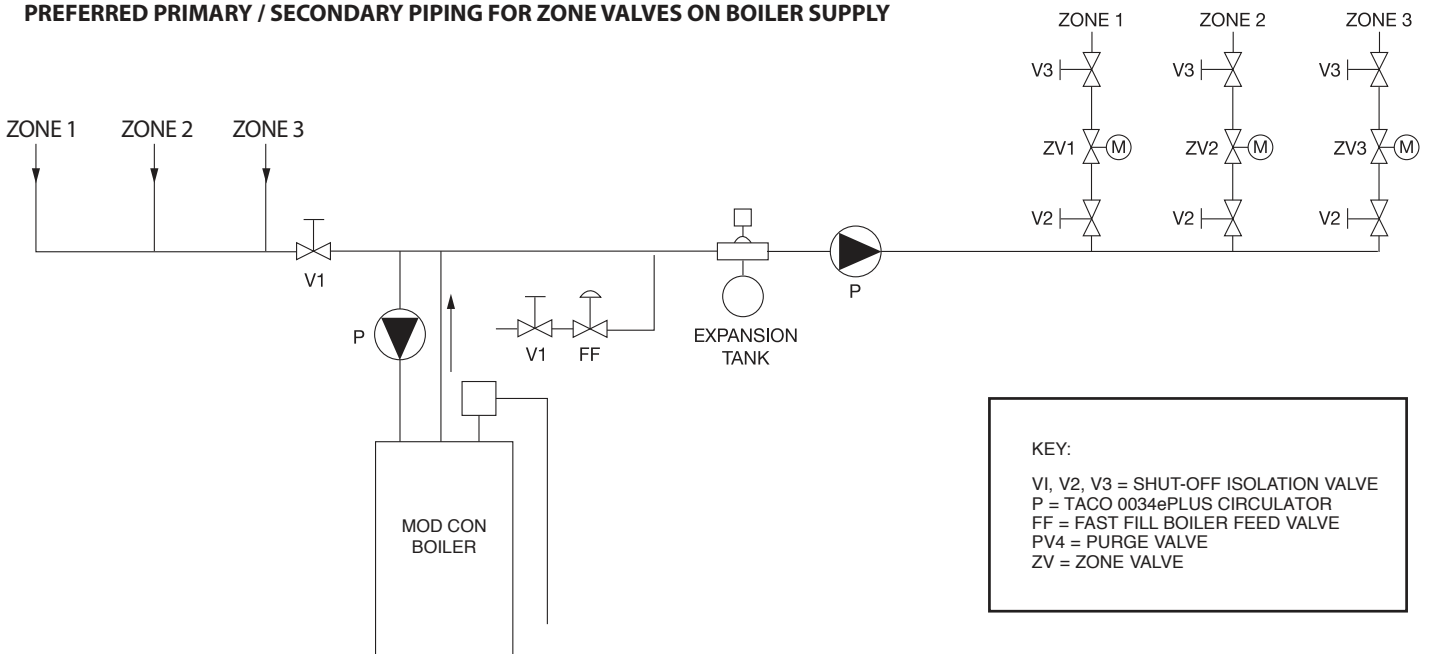

KEY:
 V1, V2, V3 = SHUT-OFF ISOLATION VALVE
 P = TACO 0034ePLUS CIRCULATOR
 FF = FAST FILL BOILER FEED VALVE
 PV4 = PURGE VALVE
 ZV = ZONE VALVE

- 1. Location:** The circulator can be installed on the supply or return side of the boiler but for best system performance, it should always pump away from the expansion tank. See piping diagrams in Figure 2 & Figure 3.

NOTE: Two shorter 1-1/4" x 7/16" flange bolts are provided with the circulator to use on the discharge flange to prevent interference with the circulator casing.

CAUTION: Do not use flat rubber gaskets. Only use O-ring gaskets provided or leaks may result. Warranty will be void.

- 2. Mounting position:** Circulator must be mounted with the motor in the horizontal position. See Figure 4 & Figure 5 below for acceptable and unacceptable motor mounting orientations. See Figure 6 for Rotating Control Cover.

Figure 4 — Acceptable Mounting Positions

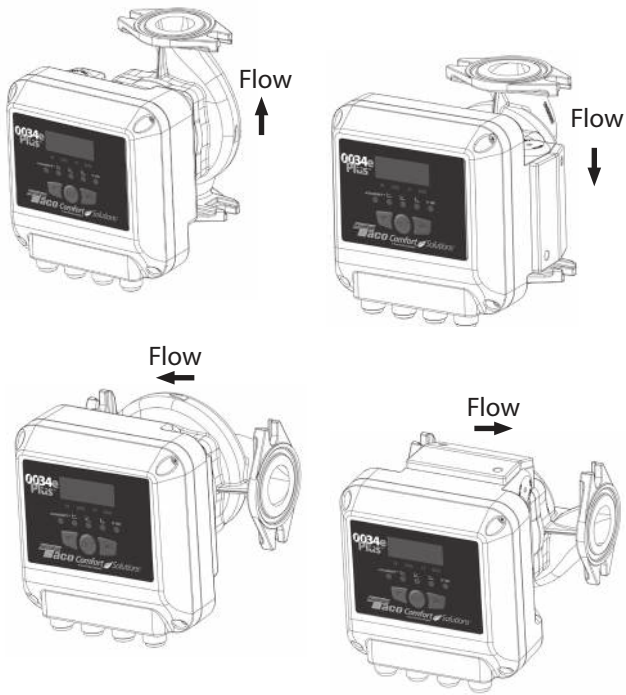

Figure 5 — Unacceptable Mounting Positions

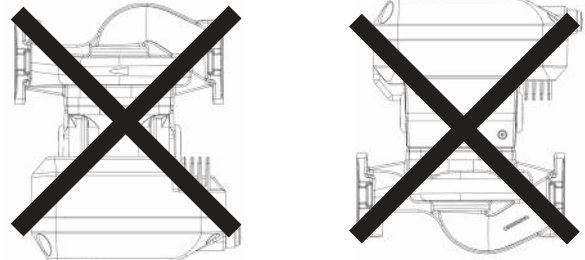
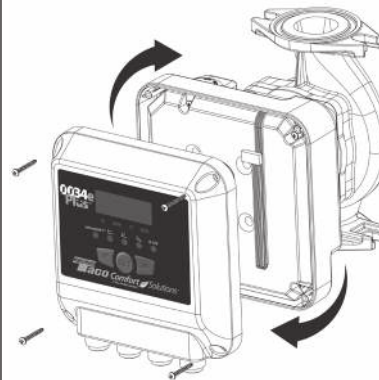

Figure 6 — Rotating Control Cover



The 0034ePlus is equipped with a symmetrical control cover connected to the pump with a ribbon cable. The cover can be removed, rotated and repositioned for best viewing and user operation. It allows the installer to mount the circulator casing in any flow direction, then rotate the cover to the upright position. Remove the 4 cover screws, rotate cover to upright position, reattach cover with 4 screws.

CAUTION: To reduce the possibility of noise transmission, be sure to add vibration dampeners to piping when mounting circulator to wall or floor joists.

ATTENTION : Pour réduire la possibilité de transmission de bruit, veillez à ajouter des amortisseurs de vibration à la tuyauterie lors du montage du circulateur sur des chevêtres de mur ou de plancher.

- 3. Filling the system:** Fill the system with tap water or a maximum of 50% propylene-glycol and water solution. The system must be filled before operating the circulator. The bearings are water lubricated and should not be allowed to operate dry. Filling the system will result in immediate lubrication of the bearings. It is always good practice to flush a new system of foreign matter before starting the circulator.

WARNING: Risk of electric shock. To reduce the risk of electric shock, be certain that it is connected only to a properly grounded, grounding-type receptacle. Follow all local electrical and plumbing codes.

AVERTISSEMENT : Risque de choc électrique. Pour réduire le risque de choc électrique, veillez à ce qu'elle soit raccordée uniquement à un réceptacle de type mise à la terre proprement mis à la terre. Respectez tous les codes de plomberie et électriques locaux.

**WARNING: Use supply wires suitable for 90°C.
AVERTISSEMENT : Employer des fils d'alimentation adéquats pour 90°C.**

**WARNING: Disconnect power when servicing.
AVERTISSEMENT : Couper l'alimentation lors de l'entretien.**

**CAUTION: Use flexible conduit only. Not for use with rigid conduit.
ATTENTION : N'utiliser que du conduit flexible ; n'est pas fait pour du conduit rigide.**

Wiring Diagram

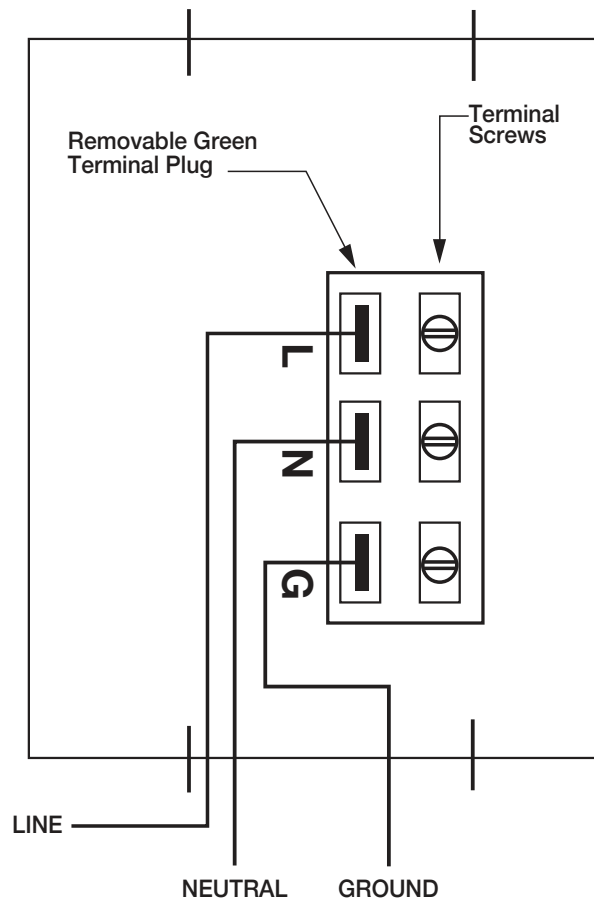

4. **Wiring the circulator:** Disconnect AC power supply. Remove terminal box cover. Attach a wiring connector into knockout hole. Use flexible conduit only. The green terminal plug may be removed to simplify wiring, then snapped back in place. Connect Line/Hot power to the L terminal, Neutral to the N terminal and Ground to the G terminal. See wiring diagram above. Replace terminal box cover. Insert rubber cap plug provided to cover unused knockout hole.
- 4a. **Wiring the circulator for 0-10V DC Operation:** (See Page 10)
5. **Start the circulator:** When purging the system, it is recommended to run the circulator at full speed long enough to remove all remaining air from the bearing chamber. This is especially important when installing the circulator in the off-season. Set operating mode to Fixed Speed on 100% HIGH setting for maximum fixed speed. A blue LED will illuminate when the 0034ePlus is powered on.

CAUTION: Never run the circulator dry or permanent damage may result.

ATTENTION: Ne laissez jamais le circulateur tourner à sec, des dommages permanents peuvent en résulter.

Full Speed Operation:

To run the pump at full speed during the fast fill, start-up and purge process, set operating mode to Fixed Speed on 100% HIGH setting. (See "Programming your 0034ePlus Circulator"). The LED will change to blue. To return to the normal operating mode, reset operating mode to desired activeADAPT, Constant Pressure, Proportional Pressure, Fixed Speed or 0-10V setting.

6. Programming your 0034ePlus circulator: Modify the performance of the circulator as needed by changing the operating mode using the easy programming button keypad. When the circulator is powered on, the LED will illuminate and change color based on the operating mode selected. The LED will flash each time a setting is changed. See diagram below to set pump for desired operating mode. The selection of the right operating curve depends on the characteristics of the system and the actual flow / head requirements. See Pump Curves on pages 7, 8, 9 & 12 to determine the best operating mode for the system. See cross-reference replacement chart on the back page.

- The 0034ePlus has 5 Operating Modes:**
- **activeADAPT® — Automatic, self-adjusting, proportional pressure, variable speed (Violet LED)**
 - **Constant Pressure — 5 curve settings of constant pressure, variable speed (Orange LED)**
 - **Proportional Pressure — 5 curve settings of proportional pressure, variable speed (Green LED)**
 - **Fixed Speed — Variable fixed speed settings (1 - 100%) (Blue LED)**
 - **0-10V DC — Analog external input or PWM pulse width modulation input from building control system, variable speed (Yellow LED)**

Change the performance of the circulator according to the need, using "SET", DOWN and UP buttons.







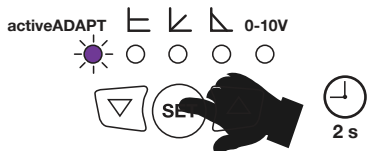

LED	FUNCTION	SETTING
 activeADAPT Purple LED (**) 	activeADAPT (*)	
 ^C Orange LED (**) 	Constant Pressure (C1 - C2 - C3 - C4 - C5)	<p>1) Press the "SET" button for 2 seconds, the LED indicating the operating status starts flashing quickly.</p>
 ^P Green LED (**) 	Proportional Pressure (P1 - P2 - P3 - P4 - P5)	
 ^{min-max} Blue LED (**) 	Variable Fixed Speed MIN - MAX (1 - 100%)	<p>2) Press the UP or DOWN buttons to select the new operating mode and the desired value for the constant, proportional and variable speed curves (See display below).</p>
 0-10V Yellow LED (**) 	0-10V DC External Input	
 W GPM FT RPM Constant Pressure (C1 - C2 - C3 - C4 - C5)	 W GPM FT RPM Proportional Pressure (P1 - P2 - P3 - P4 - P5)	 W GPM FT RPM Variable Fixed Speed MIN - MAX (1 - 100%)
<p>(*) Factory settings (**) Turns white to indicate the presence of air in the system or red to indicate the presence of an error</p>		

Figure 7 - Digital Display Operating Modes

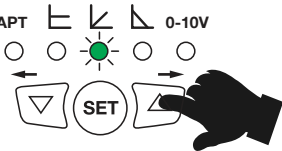
activeADAPT® Mode:

activeADAPT is an operating mode designed for constant circulation systems. On this setting, the circulator will sense changes in system flow and head conditions and adjust the operating curve automatically. See activeADAPT operating range in the chart to the right.

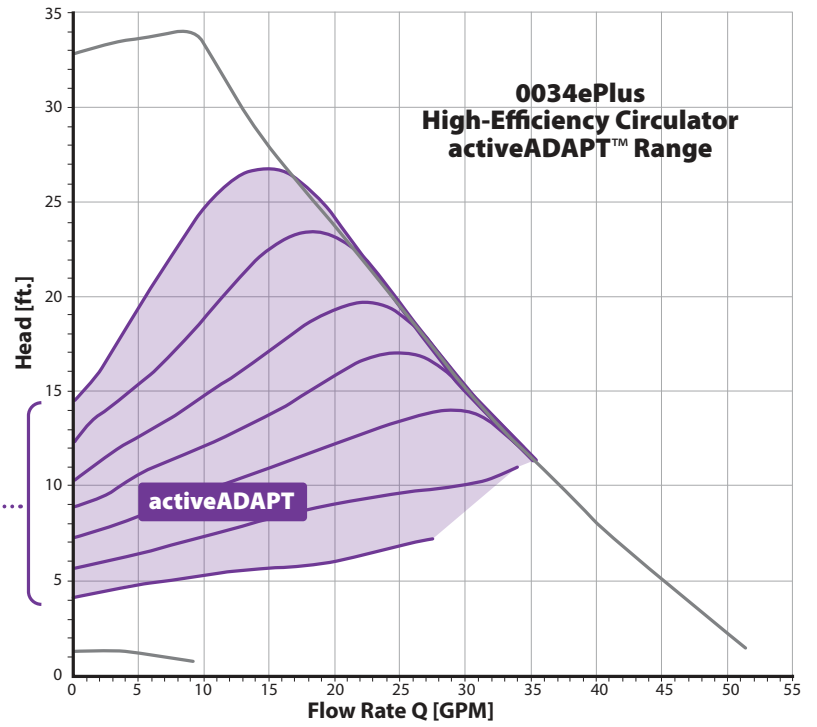

Constant Pressure Mode:

Circulator will vary speed to maintain desired feet of head constant pressure curve. There are 5 setting options: 6 - 30 feet.

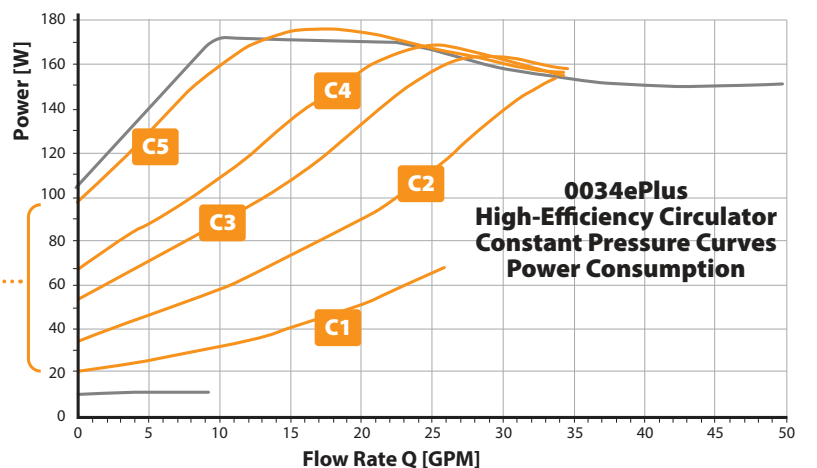
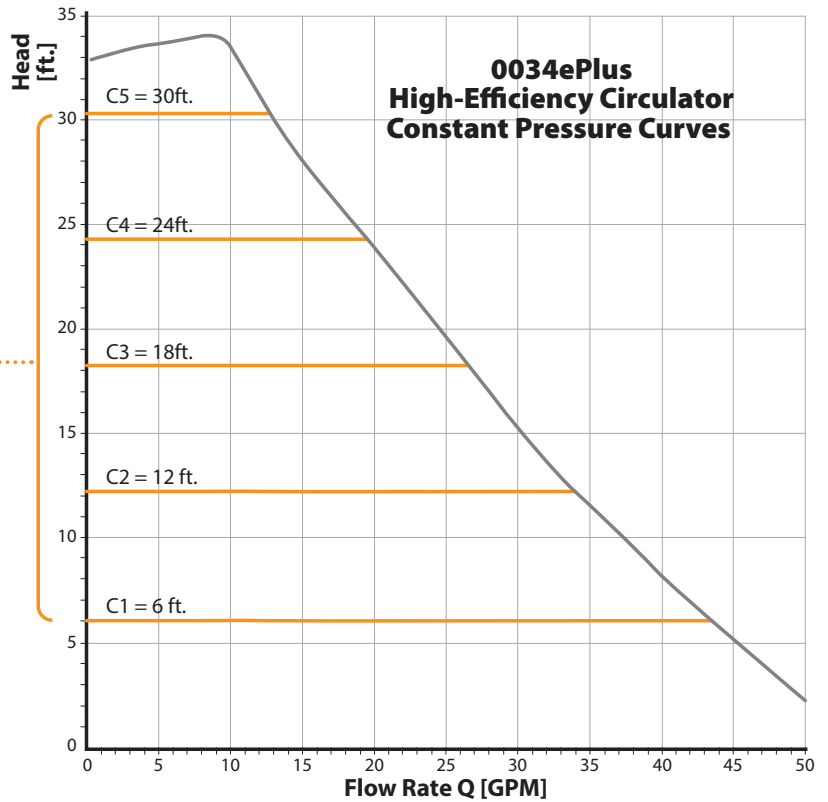

Proportional Pressure Mode:

Circulator will vary speed to maintain desired feet of head proportional pressure curve.

There are 5 setting options:
8.2 - 28.6 ft.

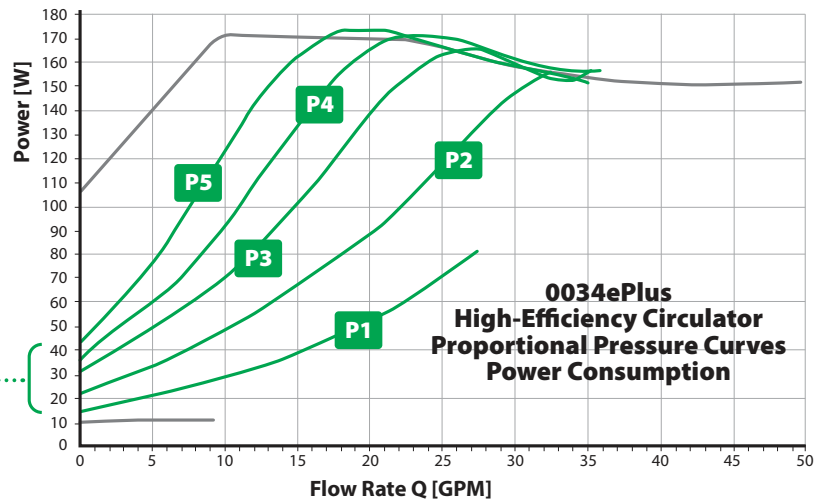
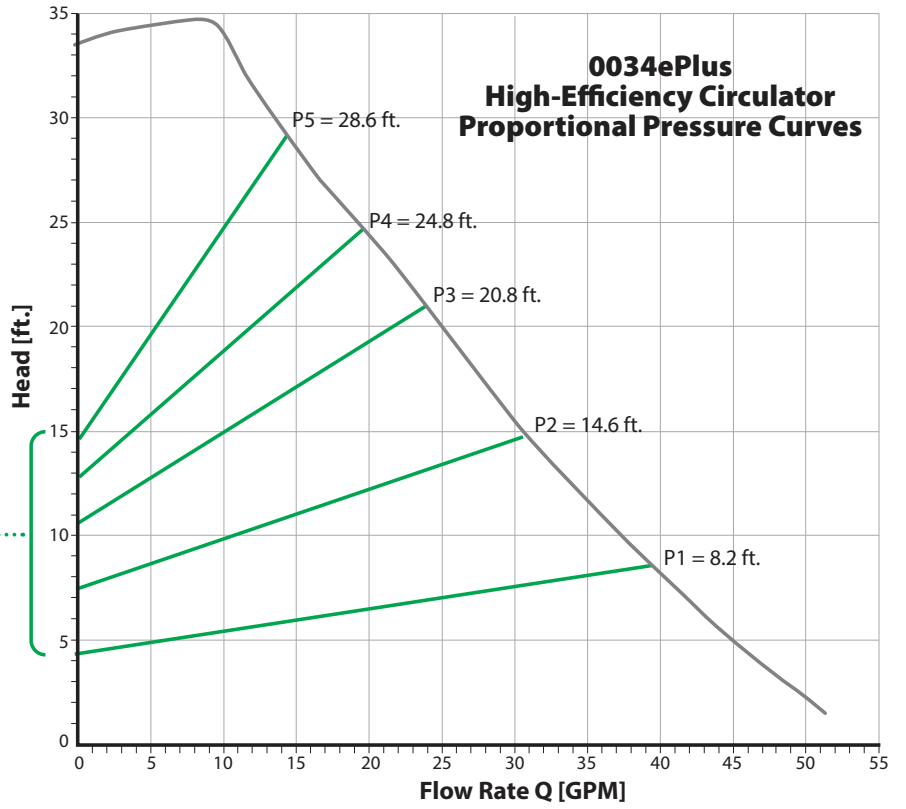

Fixed Speed Mode:

Variable fixed speed operation.
Setting from 1 - 100% speed.

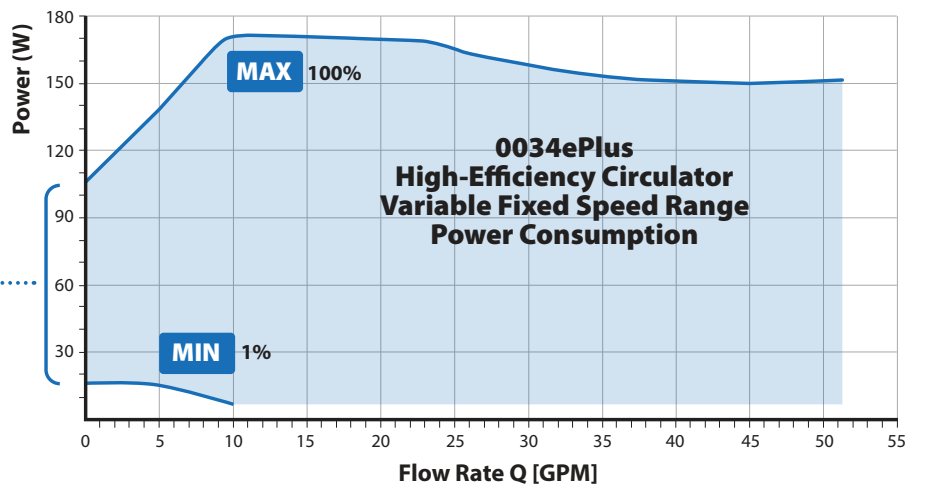
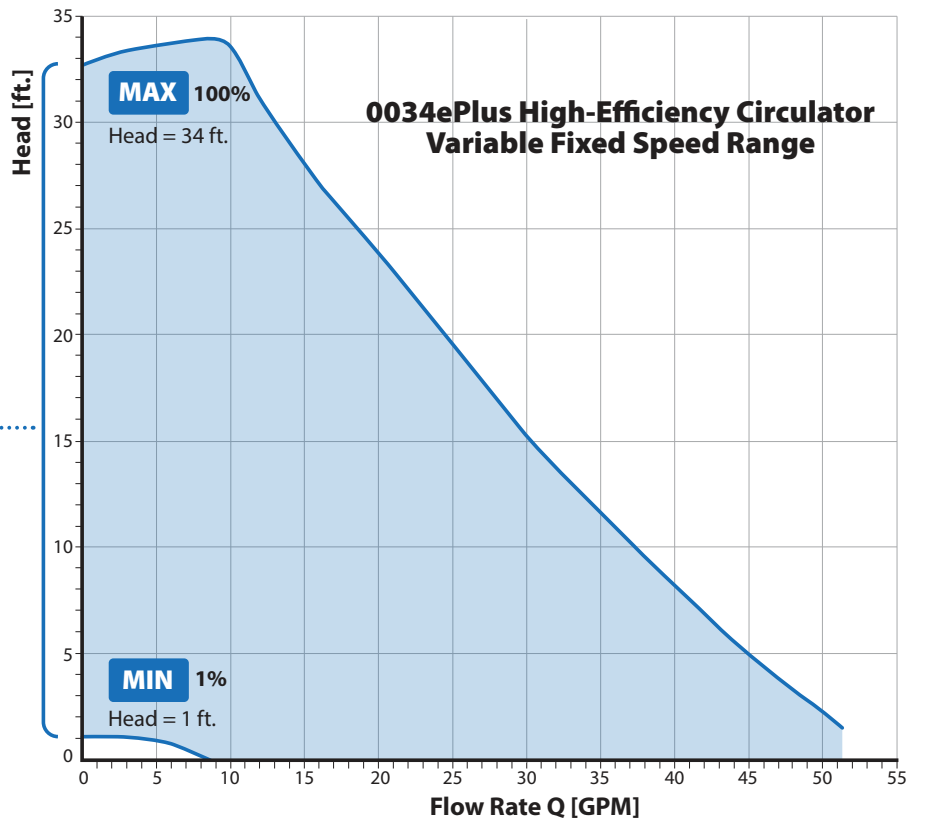
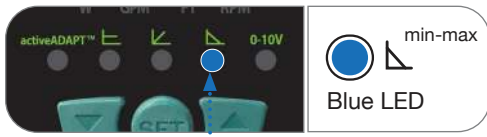

External connection for 0-10V DC / PWM signal

WARNING: If there is a need to make external connection (PLC / Pump Controller) it is mandatory to perform the following operations.

1. Remove the four screws (Figure 8 - Ref. 1) attaching the control cover (Figure 8 - Ref. 2).
2. Unscrew a signal input / output cap (Figure 8 - Ref. 3).
3. Remove the green terminal plug (Figure 8 - Ref. 4) from the electronic board (Figure 8 - Ref. 5).
4. Insert the cable (Figure 8 - Ref. 6) in the cable strain relief gland M12x1.5 (Figure 8 - Ref. 7) provided in carton and screw it to the cover.
5. Strip (Minimum .25") the ends of the wires, insert them into the connector as shown (Figure 8 - Ref. 4) and fix them with screws (Figure 8 - Ref. 8).
6. Re-connect the terminal plug to the electronic board, replace the control cover and secure it with the screws.

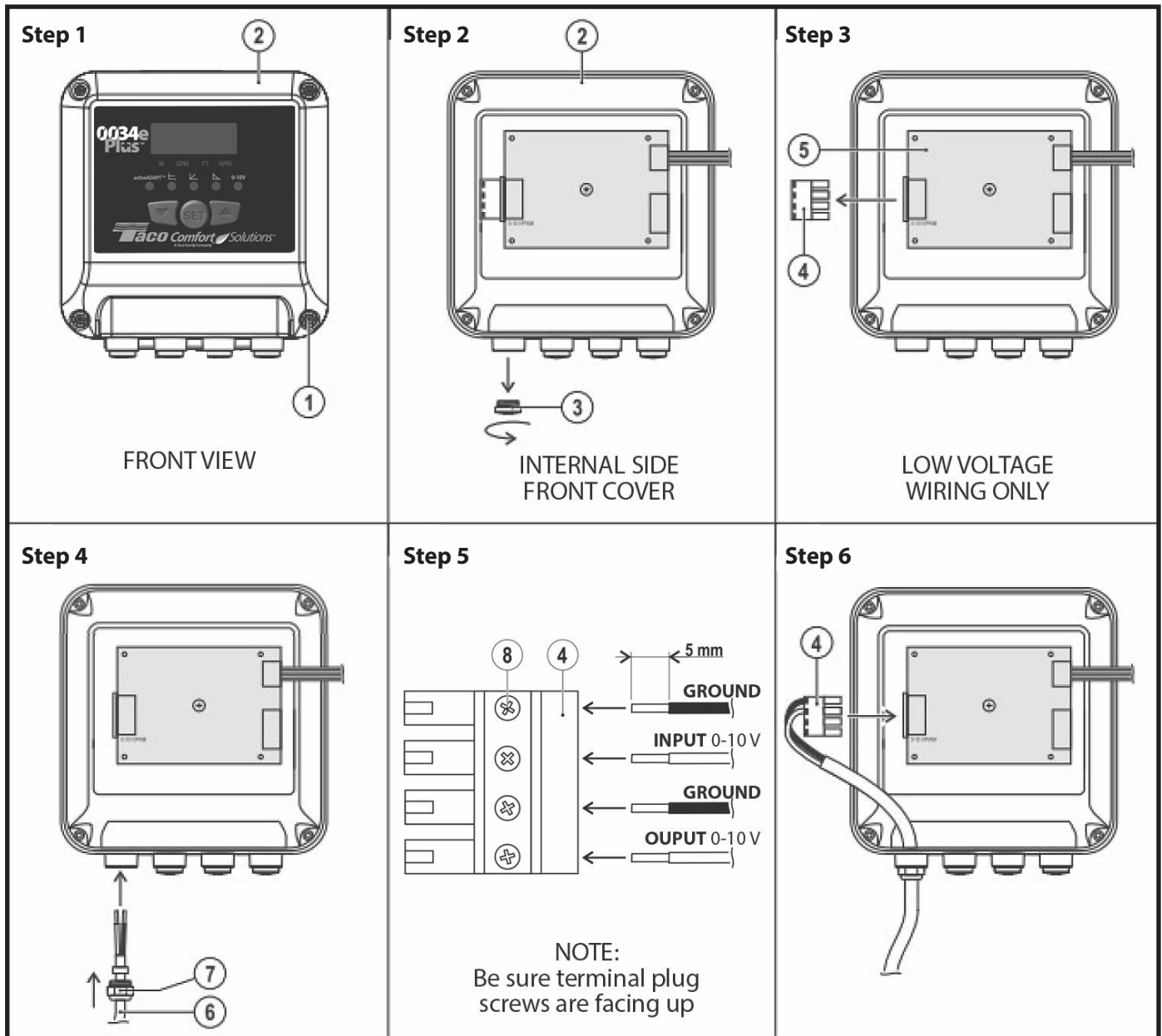

Figure 8 - External connection for 0-10V DC / PWM signal

Analog Input

In the "external input" mode, the circulator accepts either a 0-10VDC voltage signal or a PWM signal. The selection of the signal type is automatically made by the circulator without operator intervention.

Input 0-10V DC

The circulator operates at variable speed depending on the DC input voltage. At voltages below 1.5 V, the circulator is in "standby" mode. LED will be flashing yellow in "standby" mode.

At voltages between 2 V and 10 V, the circulator operates at a variable speed depending on the voltage:

- 0% for a voltage not exceeding or equal to 2 V
- 50% at 7 V
- 100% for voltages greater than or equal to 10 V

Between 1.5 V and 2 V the circulator can be in "standby" or at minimum speed depending on the previous state (hysteresis). See diagram.

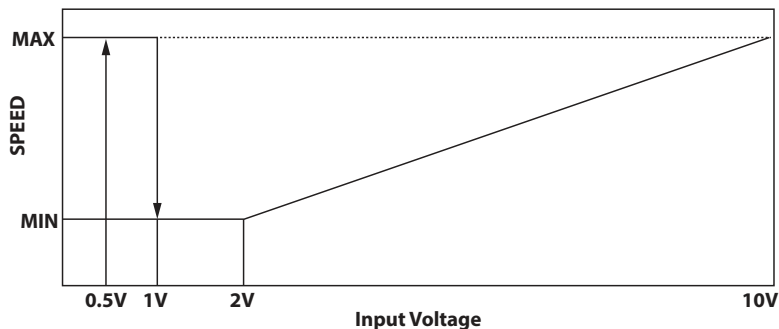

PWM Input

Circulator operates at variable speed according to digital input duty cycle. PWM digital input is shared with 0-10V DC analog input, the pump will automatically switch between different input protocols when it detects a constant frequency input signal. 0% and 100% PWM inputs are not valid and will be treated as an analog input.

PWM amplitude must be from 5 to 12V, frequency between 200Hz to 5kHz

Operations based on PWM input:

- Standby for PWM below 5%
- Min speed for PWM between 9-16%
- Half speed for 50% PWM
- Max speed for PWM in over 90%

Between 5% to 9% PWM the circulator remains in standby or run mode according to minimum threshold.

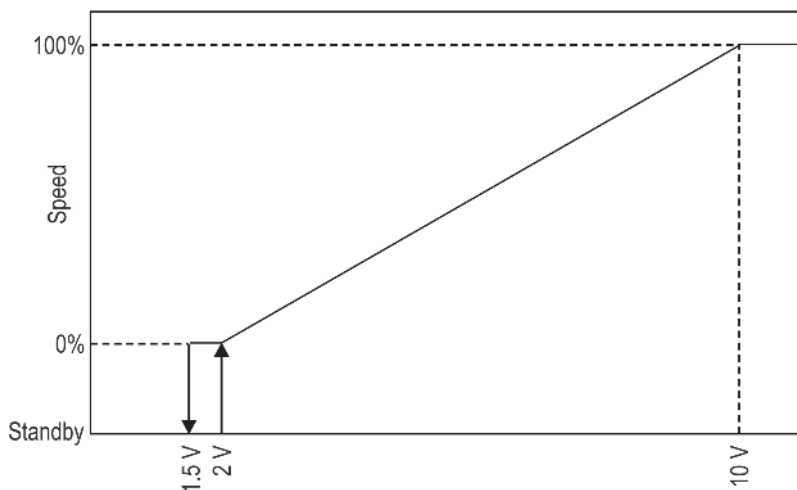

IMPORTANT: If the input remains disconnected, the circulator goes into Standby Mode.

In the operating mode with external connection for 0-10V, the "Standby" mode is indicated by the Yellow LED (flashing slowly) and the word "Stb" on the display.

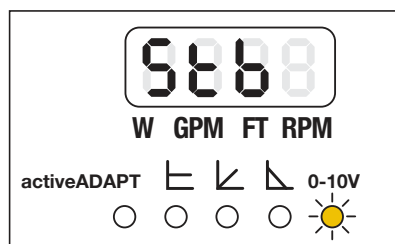

Standby Mode

Analog Output 0-10V DC

The circulator has an analog output signal feature to indicate the operating status

Voltage	State
0 V	Circulator off, not powered
2 V	Circulator powered in standby
4 V	Circulator on and running
6 V	Warning presence (overheating, air)
10 V	Alarm presence (Circulator blocked, under voltage, over temperature)

Errors List

The presence of errors is indicated by a Red LED and by the "Error Code" on the display.

Code	Meaning	Circulator Status
E1	Pump locked / Loss of step	Stop
E2	Under Voltage	Stop
E3	Overheating Warning	It operates in limited power
E4	Overheating Alarm	Stop
E5	Communication with inverter card is interrupted	It works in recover mode
E6	SW cards error. Pumps are incompatible with each other.	It works in recover mode

0-10V DC Input Mode:

The circulator will vary its speed and performance based on a 0-10V DC analog signal external input.



0-10V

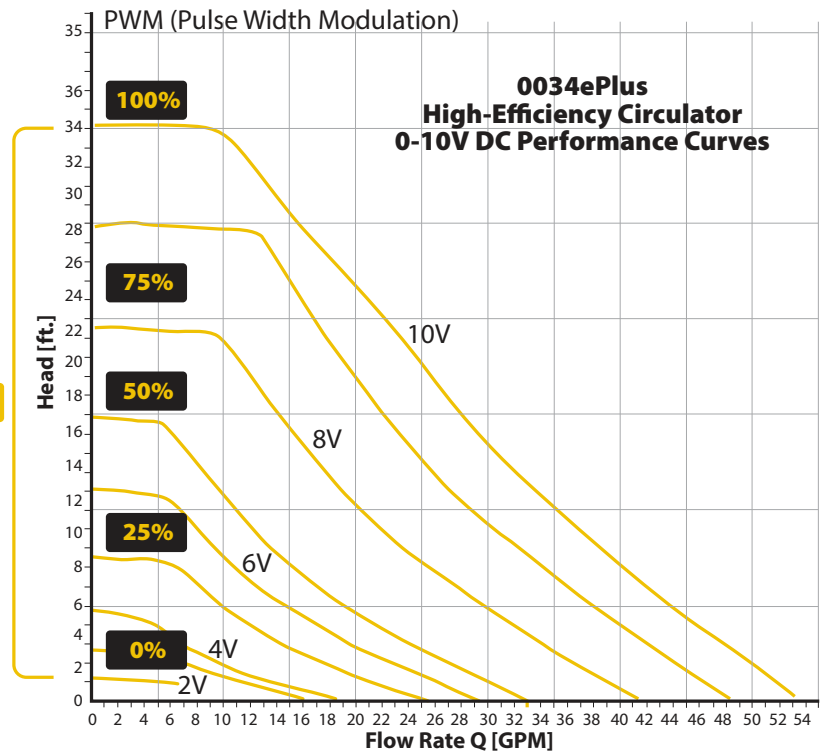

0-10V

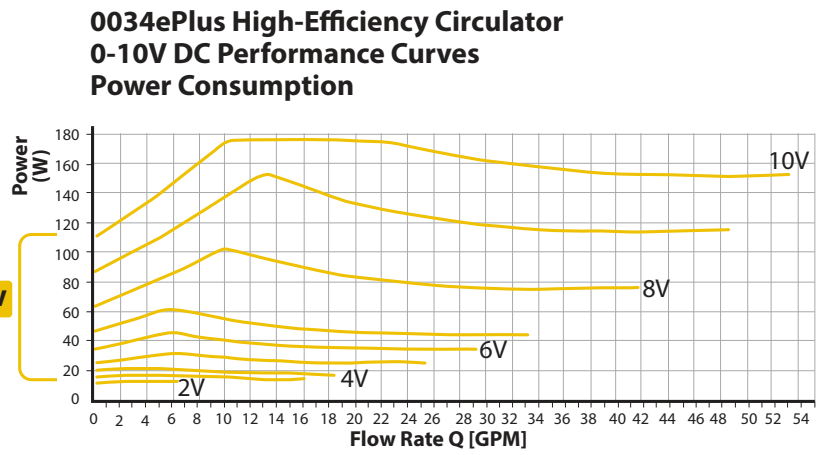

Troubleshooting the error codes:

Listed below are potential diagnostic error codes which will appear on the LED display in case of a malfunction.

FAULTS	CONTROL PANEL	CAUSES	REMEDIES
The circulator is noisy	LED on	Suction pressure is insufficient - cavitation	Increase the system suction pressure within the permissible range.
	LED on	Presence of foreign bodies in the impeller	Disassemble the motor and clean the impeller.
Loud noises of water circulation	Flashing white LED	Air in the system. Circulator may be air-bound.	Vent the system. Repeat fill and purge steps.
Circulator is not running although the electrical power supply is switched on	LED off	Lack of power supply	Verify voltage value of the electric plant. Verify the connection of the motor.
		Circuit breaker might be tripped	Check circuit breaker at panel and reset if necessary.
		The circulator is defective	Replace the circulator.
		Overheating	Let the circulator cool down for some minutes. Then try to restart it. Verify that the water and ambient temperature are within the indicated temperature ranges.
	LED red	The rotor is blocked	Disassemble the motor and clean the impeller. See unlocking procedure below.
		Insufficient supply voltage	Verify that the power supply matches the data on the name plate.
Building does not get warm	LED on	System may be air-bound	Vent system. Repeat fill and purge steps.

Unlocking Procedure: A red LED indicates the circulator is locked or sticking. Disconnect and connect power supply to start the automatic release process. The circulator makes 100 attempts to restart (process lasts approximately 15 minutes). Every restart is signaled by a short white flash of the LED. If the locking is not removed through the automatic release process after 100 attempts to restart the circulator, it goes into standby and the LED remains red. In this case follow the manual procedure described in the next steps: during any attempt, the red LED keeps blinking; after that the circulator tries again to start. If the locking is not removed through the automatic release process (the warning light returns to red), perform the manual steps described below.

1. Disconnect power supply - the warning light switches off.
2. Close both isolating valves and allow cooling. If there are no shut-off devices, drain the system so that the fluid level is beneath that of the circulator.
3. Loosen 4 motor bolts. Remove motor from casing. Carefully pull the rotor/impeller from the motor.
4. Remove impurities and deposits from the impeller and casing.
5. Reinsert the rotor/impeller into the motor.
6. Connect power supply. Check for impeller rotation.
7. If the circulator still doesn't run it will need to be replaced.

Technical Menu

Proceed as follows to access the technical menu:

- 1) Press the **UP** and **DOWN** buttons simultaneously for 5s, the message **"tECH"** will appear in the display.
- 2) Press the **"SET"** button and select the parameter to be displayed by pressing the **UP** or **DOWN** buttons. (See below).
- 3) Press the **"SET"** button and select the desired parameter.

IMPORTANT: After 10 seconds of inactivity, the circulator leaves the technical menu and returns to normal operation.

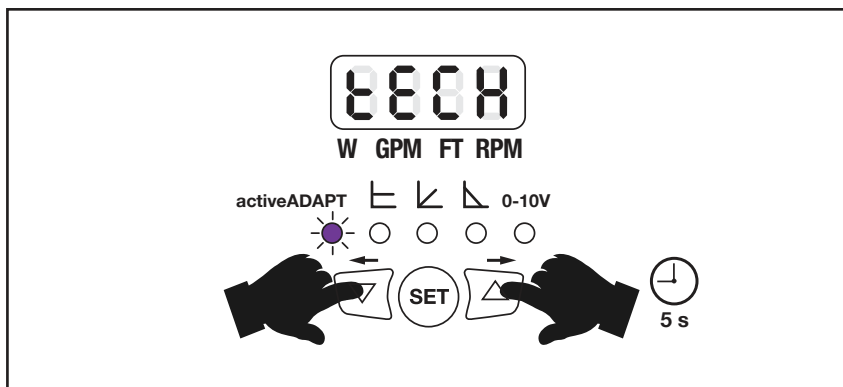

Parameters	Meaning
T 0	Display Firmware version
T 1	Inverter Firmware version
T 2	Unit of measurement shown on the display: <ul style="list-style-type: none"> • SI = System International (European) • IU = Imperial units
T 3	Maximum pump head
T 4	Analog input voltage 0-10V
T 5	"Duty Cycle" PWM input
T 6	Mains voltage
T 7	Internal inverter voltage
T 8	Pump working hours (in thousands, 0.010 = 10 hours, 101.0 = 101,000 hours)
T 9	Ignitions counter
T 10	Standby counter
T 11	Rotor blocks counter
T 12	Step losses counter
T 13	Under voltages counter
T 14	Over voltages counter
T 15	Counter for missing internal cards communications

Replacement Parts List

007-007RP	Flange Gasket set
198-213RP	Casing 'O' Ring
198-3251RP	Control Panel Cover (0034ePlus Digital Display)
198-3247RP	Terminal Box Cover
198-3185RP	Wiring Connector (Green)
198-217RP	Terminal Box cover screws (5 per bag)

0034ePlus Pump Replacement Cross Reference (6-1/2" Flange to Flange Dimension)

Taco	Bell & Gossett	Armstrong	Grundfos	Wilo
2400-10	PL 50	E 11	TP(E) 32-40	Stratos:
2400-20	PL 45	E 10	UP 50-75	1.25 x 3 – 35
2400-30	PL 36	E 8	UPS 43-100	1.25 x 3 – 30
2400-40	PL 30	E 7	UPS 50-44	1.25 x 3 – 25
110	E90 1AAB	S 25	UP 43-75	1.25 x 3 – 20
111	Series 60 (601)	H 63	UP(S) 43-44	
112	Series HV	H 52	UP 26-116	Top S:
113	Series PR	H 51	UP(S) 26-99	1.25 x 15
009	Series HV	Astro 290	UP 26-96	1.25 x 25
0010	Series 100	Astro 280	UP 26-64	1.25 x 35
0011	NRF 45	Astro 210	UPS 32-40	1.50 x 20
0012	NRF 36	1050 1B	UPS 32-80	
0013	ECOCirc XL	1050 1 1/4B	Magna 32-100	Top Z:
0014	36-45	Compass ECM	Magna 32-60	1.5 x 15
			Alpha2 26-99	1.5 x 20

NOTE: Flange size and flange to flange dimensions will vary by competitive model and may require some piping changes.

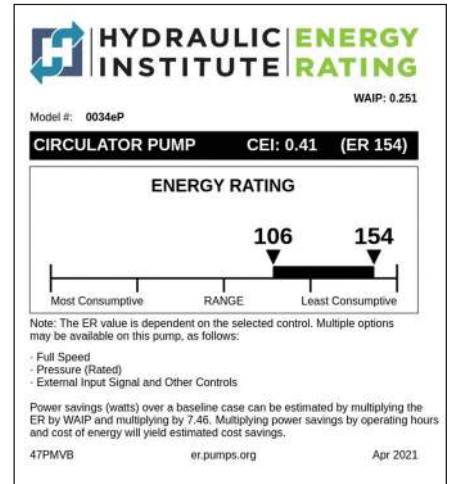

LIMITED WARRANTY STATEMENT

Taco, Inc. will repair or replace without charge (at the company's option) any Taco product which is proven defective under normal use within three (3) years from the date code.

In order to obtain service under this warranty, it is the responsibility of the purchaser to promptly notify the local Taco stocking distributor or Taco in writing and promptly deliver the subject product or part, delivery prepaid, to the stocking distributor. For assistance on warranty returns, the purchaser may either contact the local Taco stocking distributor or Taco. If the subject product or part contains no defect as covered in this warranty, the purchaser will be billed for parts and labor charges in effect at time of factory examination and repair.

Any Taco product or part not installed or operated in conformity with Taco instructions or which has been subject to misuse, misapplication, the addition of petroleum-based fluids or certain chemical

additives to the systems, or other abuse, will not be covered by this warranty.

If in doubt as to whether a particular substance is suitable for use with a Taco product or part, or for any application restrictions, consult the applicable Taco instruction sheets or contact Taco at (401-942-8000).

Taco reserves the right to provide replacement products and parts which are substantially similar in design and functionally equivalent to the defective product or part. Taco reserves the right to make changes in details of design, construction, or arrangement of materials of its products without notification.

TACO OFFERS THIS WARRANTY IN LIEU OF ALL OTHER EXPRESS WARRANTIES. ANY WARRANTY IMPLIED BY LAW INCLUDING WARRANTIES OF MERCHANTABILITY OR FITNESS IS IN EFFECT ONLY FOR THE DURATION OF THE EXPRESS WARRANTY SET FORTH IN THE FIRST PARAGRAPH ABOVE.

THE ABOVE WARRANTIES ARE IN LIEU OF ALL OTHER WARRANTIES, EXPRESS OR STATUTORY, OR ANY OTHER WARRANTY OBLIGATION ON THE PART OF TACO.

TACO WILL NOT BE LIABLE FOR ANY SPECIAL INCIDENTAL, INDIRECT OR CONSEQUENTIAL DAMAGES RESULTING FROM THE USE OF ITS PRODUCTS OR ANY INCIDENTAL COSTS OF REMOVING OR REPLACING DEFECTIVE PRODUCTS.

This warranty gives the purchaser specific rights, and the purchaser may have other rights which vary from state to state. Some states do not allow limitations on how long an implied warranty lasts or on the exclusion of incidental or consequential damages, so these limitations or exclusions may not apply to you.

Taco Comfort Solutions A Taco Family Company

Taco, Inc., 1160 Cranston Street, Cranston, RI 02920 | Tel: (401) 942-8000 | FAX: (401) 942-2360

Taco (Canada), Ltd., 8450 Lawson Road, Suite #3, Milton, Ontario L9T 0J8 | Tel: (905) 564-9422 | FAX: (905) 564-9436

Visit our web site: www.TacoComfort.com | ©2021 Taco, Inc.

