

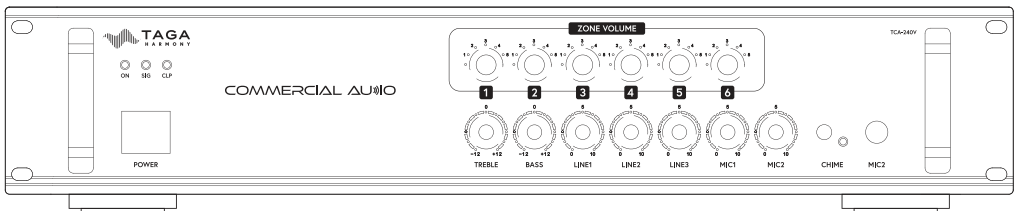

COMMERCIAL AU»IO

TCA Series

100V MULTIZONE MONO MIXING AMPLIFIERS



Instruction manual

Introduction

Thank you for purchasing TAGA Harmony amplifier.

The TCA series amplifiers are perfect solution for commercial installations in restaurants, pubs, shops, conferencing rooms, fitness clubs for both background music playback and paging (voice announcement) systems.

This amplifier allows to build a cost-effective multi-zone installation and mix music from analog inputs with voice announcements.

A variety of features and wired connections makes this amplifier a very versatile device with ability to work in different applications:

- Multi-zone mono amplification for 100V speaker lines to deliver sound to many rooms (zones); with an independent volume level.
- Multiple analog LINE inputs mixing.
- Compatibility with low-impedance speakers (selected models).
- Microphone input(s) with mixing for voice paging and broadcasting.
- Microphone input with priority (selected models).
- Chime to notify that a voice announcement is to be broadcasted (selected models).
- Treble / Bass regulation (one for all zones).
- Mono output to connect additional power amplifier, subwoofer or powered speakers (selected models).
- Signal and overload indicators.
- Cooling fan allows long time operation.
- Screw-in Speaker Connectors.

IMPORTANT REMARKS

Please read this instruction manual carefully before installation and keep it for future reference.

- This amplifier is intended for indoor use only.
- Because the 70V/100V technology requires adequate technical knowledge we recommend having a licensed professional engineer or designer reviewed the design and installation of the system focusing on safety and performance of the application.
- Model name coding TCA-###V.

◇ **TCA** - is the series name

◇ **###** - is a number representing amplifier total output power in watts

◇ **V** – means high voltage technology

For instance: TCA-240V is a high-voltage amplifier with the total output power of 240 watts.

- This amplifier is equipped in a ventilation fan which can generate noise – this is normal operation.
- When switching on and off your audio equipment, turn down the volume to avoid strong electrical impact to be delivered to the speaker.

Cleaning

Do not use strong or abrasive cleaners. Use a damp, soft cloth for cleaning.

Specifications and the latest instruction manual edition

Full technical specifications and the latest edition of the instruction manual are available on www.Tagaharmony.com.

Contents

Safety Instructions	5
Front and Rear Panel	7
Rack installation	7
Speaker Connection	9
Hooking up the Amplifier	14
Operation	16
Kit Content	19

Safety Instructions

IMPORTANT
READ THIS SECTION CAREFULLY BEFORE PROCEEDING!



CAUTION

RISK OF ELECTRIC SHOCK
DO NOT OPEN



WARNING: TO REDUCE THE RISK OF FIRE OR ELECTRIC SHOCK, DO NOT EXPOSE THIS PRODUCT TO RAIN OR MOISTURE. DO NOT REMOVE COVER (OR BACK). NO USER-SERVICEABLE PARTS INSIDE. REFER SERVICING TO QUALIFIED SERVICE PERSONNEL.



The triangle containing a lightning symbol is intended to alert the user to the presence of uninsulated dangerous voltages within the product's enclosure that may be of sufficient magnitude to constitute a risk of electric shock to persons.



An exclamation mark in a triangle is intended to alert the user to the presence of important operating and maintenance (servicing) instructions in the literature accompanying the appliance.

WARNING: TO REDUCE THE RISK OF FIRE OR ELECTRIC SHOCK, DO NOT EXPOSE THIS APPARATUS TO RAIN OR MOISTURE, AND OBJECTS FILLED WITH LIQUIDS, SUCH AS VASES, SHOULD NOT BE PLACED ON THIS APPARATUS.

CAUTION: TO PREVENT ELECTRIC SHOCK, FULLY AND SECURELY INSERT THE POWER CABLE PLUG INTO THE POWER OUTLET, AND POWER CABLE CONNECTOR INTO THE UNIT SOCKET (IF THIS UNIT IS NOT EQUIPPED WITH AN INTEGRATED [ATTACHED] POWER CORD).

CAUTION: FOR CONTINUED PROTECTION AGAINST RISK OF FIRE, REPLACE THE FUSE (IF THE UNIT IS EQUIPPED WITH A USER REPLACEABLE FUSE) ONLY WITH THE SAME AMPERAGE AND VOLTAGE TYPE. IN CASE WHEN THE UNIT IS NOT EQUIPPED WITH A USER REPLACEABLE FUSE - REFER REPLACEMENT TO QUALIFIED SERVICE PERSONNEL.

WARNING: THE UNIT MAY BECOME HOT. ALWAYS PROVIDE ADEQUATE VENTILATION TO ALLOW FOR COOLING. DO NOT PLACE THE UNIT NEAR A HEAT SOURCE, OR IN SPACES THAT CAN RESTRICT VENTILATION.

Safety Instructions

1. Read Instructions - All the safety and operating instructions should be read before the product is operated.
2. Retain Instructions - The safety and operating instructions should be retained for future reference.
3. Heed Warnings - All warnings on the product and in the operating instructions should be adhered to.
4. Follow Instructions - All operating and use instructions should be followed.
5. Cleaning - Unplug this product from the power outlet before cleaning. Do not use liquid cleaners or aerosol cleaners.
6. Water and Moisture - Do not use this product near water - for example, near a bath tub, wash bowl, kitchen sink or laundry tub; in a wet basement; or near a swimming pool; and the like. These precautions also apply to the power cord.
7. Accessories - Do not place this product on an unstable cart, stand, tripod, bracket or table. The product may fall, causing serious injury to a child or adult and serious damage to the product. Use only with a cart, stand, tripod, bracket or table recommended by the manufacturer or sold with the product. Any mounting of the product should follow manufacturer's instructions and should use a mounting accessory recommended by the manufacturer.
8. Ventilation - This unit may be equipped with slots and openings in the cabinet (housing) which are provided for ventilation and to ensure reliable operation of the product and to protect it from overheating and these openings must not be blocked or covered. The openings should never be blocked by placing the product on a bed, sofa, rug or other similar surface. This product should be not placed in a built-in installation such as a bookcase or rack unless proper ventilation is provided or the manufacturer's instructions have been adhered to. For products equipped with a separate power supply unit, leave at least 5cm (2in.) of free space on all sides and the top of the power supply.
9. Power Sources - This product should be operated only from the type of power source indicated on the marking label (placed on the product and/or, if applicable, on a separate power supply unit). If you are not sure of the type of power supply in your home, consult your product dealer or local power company. For products intended to operate from battery power or other sources, refer to the operating instructions.
10. Grounding and Polarity - some units for proper operation or to take full advantage of their capabilities may require to be connected to a grounded power outlet - refer to the user manual for more information.
Some units may have markings for the live (L) and neutral (N) conductors for power - in order to take full advantage of capabilities of such products, it is recommended to properly connect the polarity according to the markings on the unit - refer to the user manual for more information. Connecting the polarity not in accordance with the markings will not affect the durability and reliability of the device.
11. Power-cord Protection - Power supply cords should be routed so that they are not likely to be walked on or pinched by items placed upon or against them, paying particular attention to cords at plugs, convenience receptacles and the point where they exit from the product.
12. Lighting - For added protection for this product during a lighting storm or when it is left unattended and unused for long periods of time, unplug it from the wall outlet and disconnect the antenna or system cables. This will prevent damage to the product due to lighting and power-line surges.
13. Overloading - Do not overload wall outlets, extension cords or integral convenience receptacles as this can result in a risk of fire or electric shock.
14. Object and Liquid Entry - Never push objects of any kind into this product through openings as they may touch dangerous voltage points or short-out parts that could result in a fire or electric shock. Do not expose this apparatus to dripping or splashing and ensure that no objects filled with water, such as vases are placed on the apparatus.
15. Servicing - Do not attempt to service this product yourself as opening or removing covers may expose you to dangerous voltage or other hazards. Refer all servicing to qualified service personnel.
16. Damage Requiring Service - Unplug this product from wall outlet and refer servicing to qualified personnel under the following conditions:
 - when power supply cord or plug is damaged;
 - if liquid has been spilled or objects have fallen into the product;
 - if the product does not operate normally by following the operating instructions. Adjust only those controls that are covered by the operating instructions as an improper adjustment of other controls may result in damage and will require extensive work by a qualified technician to restore the product to its normal operation;
 - if the product has been dropped or damaged in any way;
 - if the product exhibits a distinct change in performance - this indicates a need for a service.
17. Replacement Parts - when replacement parts are required, be sure the technician has used replacement parts specified by the manufacturer or with the same characteristics as the original part. Unauthorized substitutions may result in fire, electric shock or other hazards.
18. Safety Check - Upon completion of any service or repairs to this product, ask the service technician to perform safety check to determine that the products is in proper operating condition.
19. Wall of ceiling mounting - The product should be mounted to a wall or ceiling only as recommended by the manufacturer.
20. Heat - The product should be situated away from heat sources such as radiators, heat registers, stoves or other products (including amplifiers) that produce heat.
21. [Refers to products equipped with vacuum tubes] Tube Cage or cover - For your safety and to protect the vacuum tubes this product may be equipped with the factory installed vacuum tube cage or cover.
It is not recommended to remove the cage or cover unless it is required to change the vacuum tubes.
When the cage or cover is removed - do not touch the vacuum tubes - they may be hot and burn the skin!
22. Operating Environment - Operating environment temperature and humidity of the unit: +5°C to +35°C (+41°F to +95°F); less than 85% RH (cooling slots not blocked).

PACKAGING WARNING

The packaging may contain elements such as plastic, that **should be kept away from small children.**

The thin foil or small elements can stick to the nose and mouth, or may be swallowed and prevent breathing.



Front and Rear Panel

TCA-240V model shown - available controls and inputs as well as their placement may vary depending on the model.

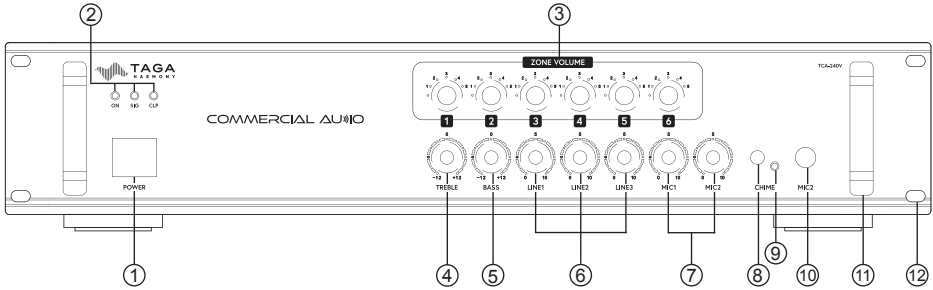

Front panel

1. POWER Switch (1 – ON, 0 – OFF)
2. Status LED Indicators:
 - ON – Power Status
 - SIG – Signal Status
 - CLP – Clipping Status
3. ZONE VOLUME – Volume Regulators for each zone
4. TREBLE Regulator
5. BASS Regulator
6. LINE1 / LINE2 / LINE3 – Line Input Mixing Regulators
7. MIC1 / MIC2 – Microphones Mixing Regulators
8. CHIME – Voice Announcement Button
9. CHIME Status LED Indicator
10. MIC2 – Microphone number 2 Jack Input [6.3mm (1/4")]
11. Handle
12. Rack mount hole

Front and Rear Panel

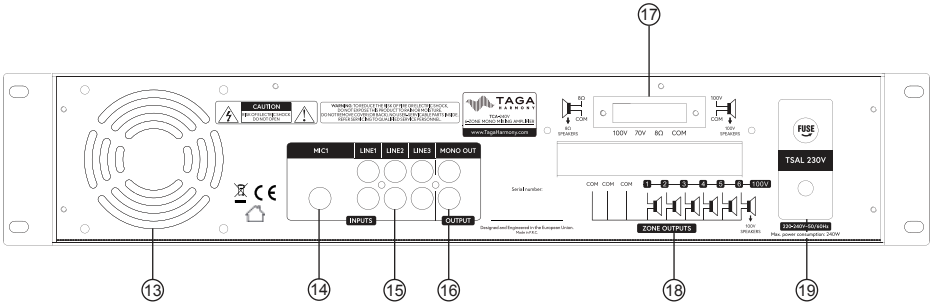

Rear panel

- 13. Ventilation fan
- 14. MIC1 - Microphone number 1 Jack Input [6.3mm (1/4")]
- 15. LINE1 / LINE2 / LINE3 – Analog RCA Inputs (both L/R channels are mixed together)
- 16. MONO OUT – Analog RCA Output in Mono
- 17. Additional Speaker Output – 100V, 70V or 8Ω (Screw-in Speaker Connectors)
- 18. ZONE OUTPUTS -100V Speaker Output (Screw-in Speaker Connectors)
- 19. Power Cable and Fuse Box



A blown fuse should be only exchanged for exactly the same type as indicated on the rear amplifier panel. The Power Cable should be disconnected!

Rack installation

This amplifier is designed for installation in a 482mm (19") width rack unit as well as can be used as a tabletop amplifier.

In the rack the amplifier requires a space of 2 RS (2 rack spaces = 89mm).

- Hold the amplifier by the handles in position and secure it in the rack with the four mounting bolts (insert them in the rack mount holes).
- The mounting bolts alone may be not sufficient for fixing the amplifier safely. We recommend to use additional lateral rails or a bottom plate to secure the amplifier in the rack.

Note! Installation bolts and accessories are not supplied with the product.



- To prevent the rack from becoming top-heavy insert the amplifier into the lower section of the rack.
- Make sure that the hot air is dissipated from the rack – otherwise you may damage the amplifier and/or other equipment installed in the rack – this will void your warranty.

Speaker Connection

The Speaker Connectors can accommodate up to 10AWG speaker cables. A 10AWG cable is recommended for longer connections (longer than 20 meters / 66 feet). For shorter lengths you can use 12/14 or 18 AWG cables. It is recommended to leave about 150 cm (5 feet) of extra cable at the amplifier end to facilitate positioning and installation of the amplifier. Do not use staples, nails or other metal objects to secure the cables. You will get the best sound quality and least amount of hum by keeping the cables away from other electrical wires and cables.

Connecting cables

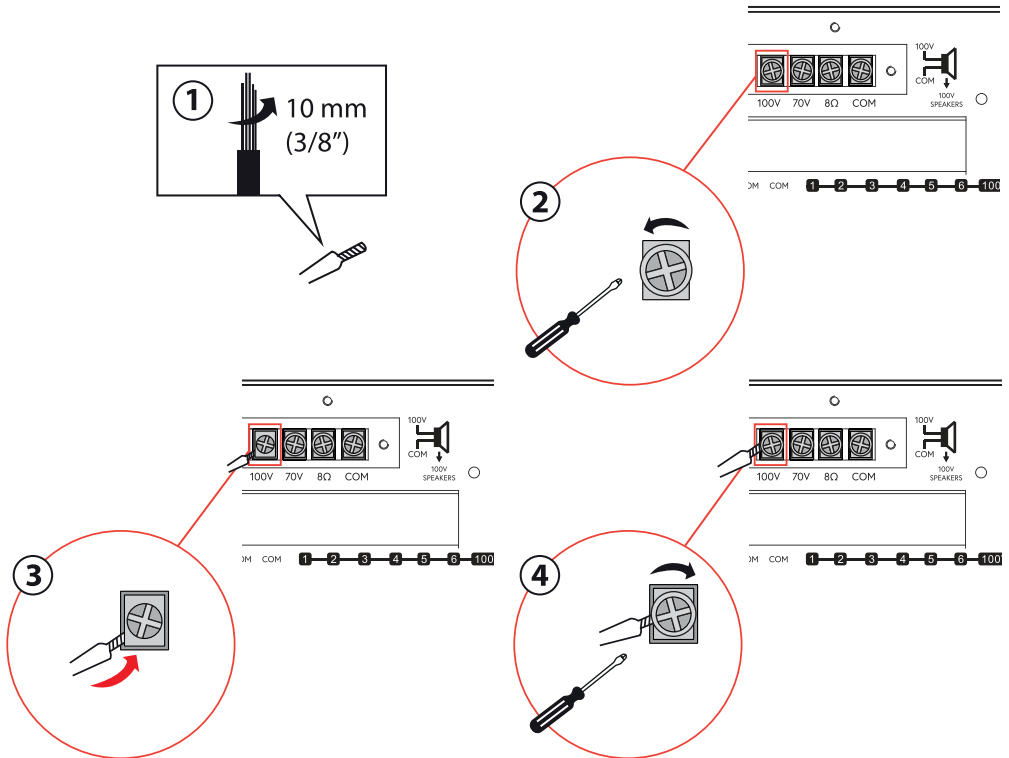

- Before connecting the speaker make sure that the amplifier is switched off - otherwise you may damage the amplifier and/or the speakers and void your warranty.
- Avoid to short-circuit of cables – it may damage the amplifier and/or the speakers and void your warranty.

Speaker Connection

Connection modes

This amplifier can be connected to 100V or 70V speakers [100V or 70V mode] or low-impedance speakers [low-impedance mode].



Never connect 100V and 70V and low-impedance speakers simultaneously - it may damage the amplifier and/or the speakers and void your warranty. Connect and use only one type of speakers (100V or 70V or low-impedance speakers) at the same time.

100V or 70V mode – connection



- Make sure to use a 100V or 70V speaker for this mode - otherwise it may damage the amplifier and/or the speakers and void your warranty.
- Make sure that the total wattage of all connected speakers will not exceed the output power of this amplifier [check technical specifications on the www.tagaharmony.com website] - otherwise you may damage the amplifier and/or the speakers and void your warranty.
- 70V connection is not available for the ZONE OUTPUTS.

100V connection - using speaker cables connect 100V amplifier speaker connector to the 100V power input speaker terminal of your speaker (usually marked as 100V or in RED color or +) and COM amplifier speaker connector to the common input of your speaker (usually marked as COM or in BLACK color or -).

70V connection - using speaker cables connect 70V amplifier speaker connector to the 70V power input speaker terminal of your speaker (usually marked as 70V or in RED color) and COM amplifier speaker connector to the common input of your speaker (usually marked as COM or in BLACK color).

Speaker Connection

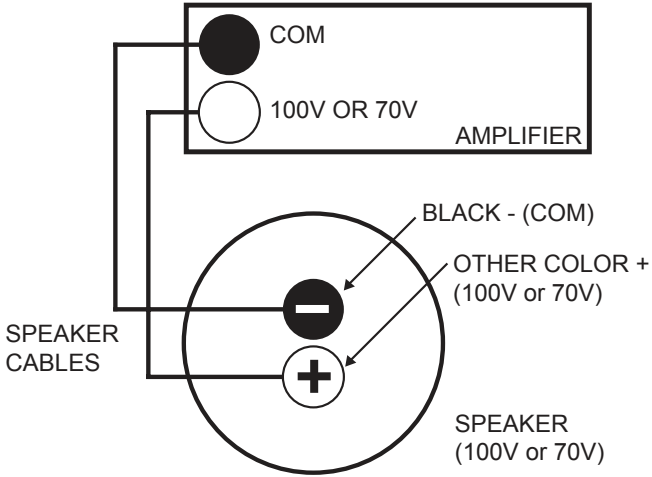

Low-impedance mode – connection



- Make sure that your speaker is suitable to work and is compatible with the amplifier working impedance - otherwise you may damage the amplifier and/or the speakers and void your warranty.
- The low-impedance output is marked with Ω sign (usually 8 Ω or 6 Ω or 4 Ω). Choose this output if you intend to use a low-impedance speaker.
- Pay attention to connecting the polarity of the speaker wire terminals correctly with the amplifier speakers connectors (RED + in the speaker with the output marked with Ω sign in the amplifier ; BLACK - in the speaker with the output marked with COM sign in the amplifier).

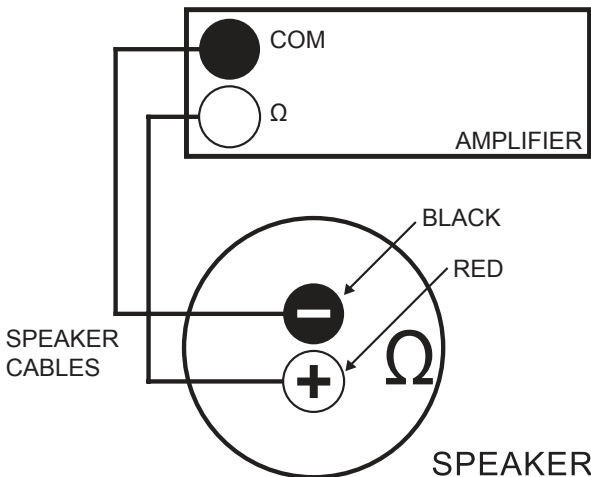

Speaker Connection

Connection options

This amplifier offers two connection options for the speaker : Additional Speaker Output and Zone Outputs.



- Never connect both connection options simultaneously - it may damage the amplifier and/or the speakers and void your warranty.
- Use only one option (Additional Speaker Output or Zone Outputs) at the same time.

Additional Speaker Output

This output is used for a single zone for 100V or 70V or low-impedance speakers.

/TCA-240V model and low-impedance connection shown/

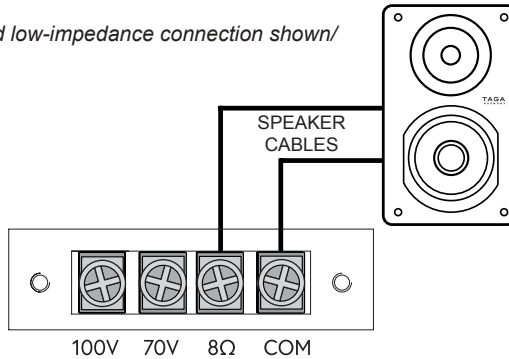

Zone Outputs

This output is used for multiple zones for 100V speakers. You can connect any combination of zones according to your application requirements.

/TCA-240V model and one zone 100V connection shown/

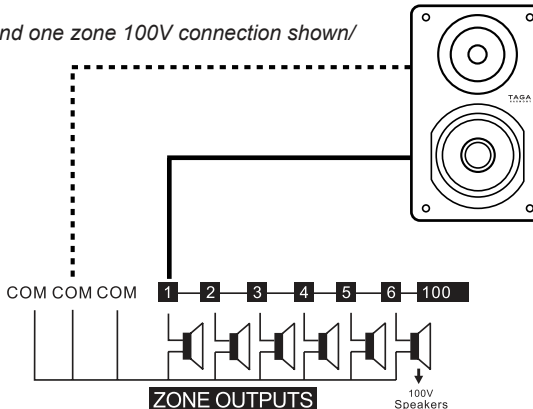

Speaker Connection

/TCA-240V model and 6-zone 100V connection shown/

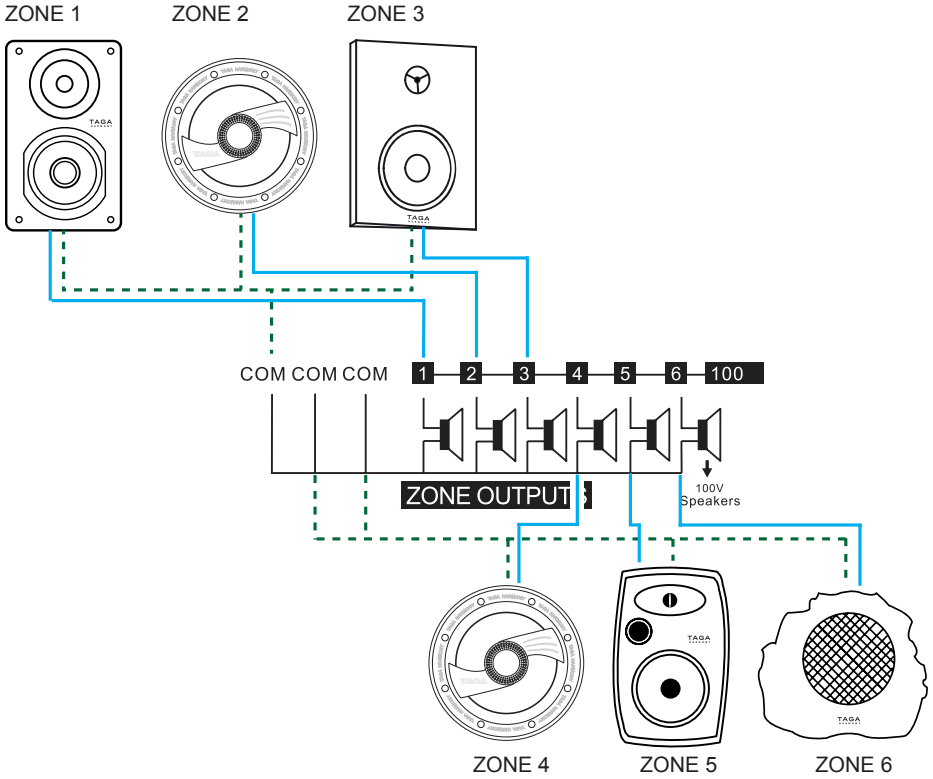

Hooking up the Amplifier



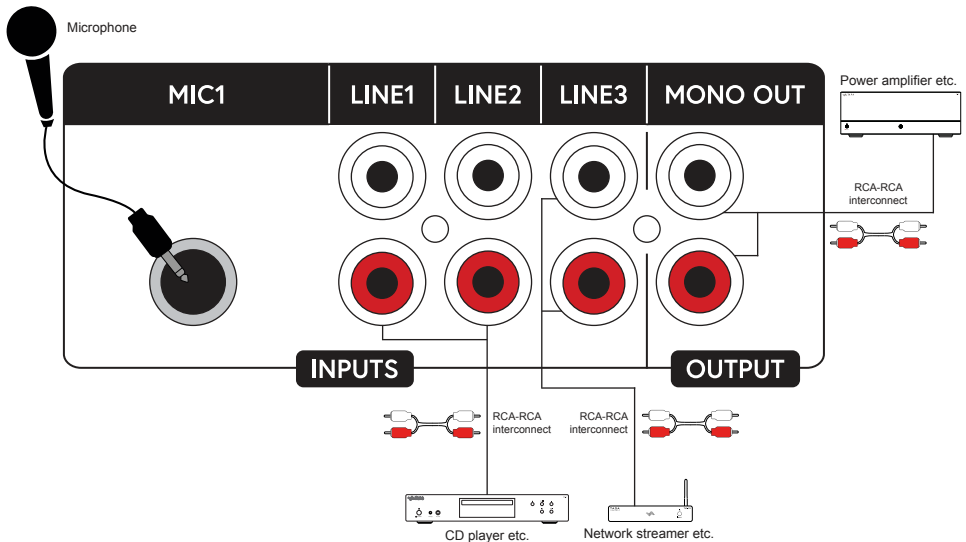
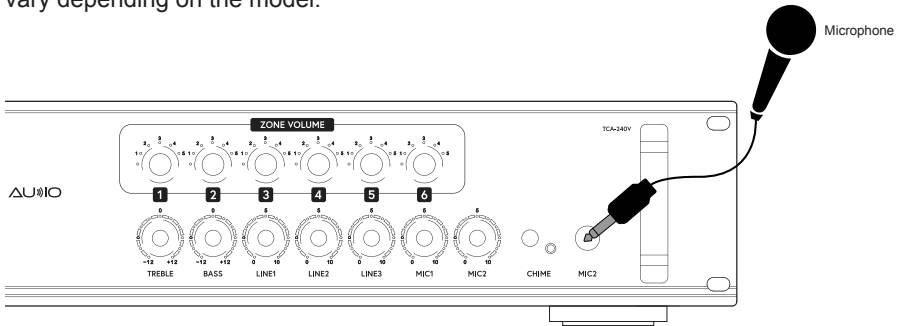







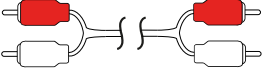

TCA-240V model shown - available controls and inputs as well as their placement may vary depending on the model.

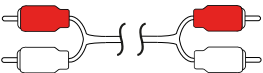

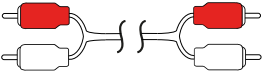
1. Make sure the amplifier is turned off (the Power Switch in 0 and the Power Cable is removed from the power outlet).
2. Turn the Volume Regulator of each ZONE, LINE and MIC to MIN (max counter clockwise).
3. Using speaker cables (not supplied with this product) connect your speakers to the connectors (check „Speaker connection” for more details).
4. Using RCA-RCA interconnect cables connect analog audio source devices you want to play (CD player, network player or FM tuner, video console etc.) to the Analog RCA Inputs (LINE).

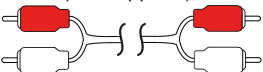
Hooking up the Amplifier

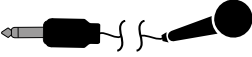
- If you want to transfer audio signal from this amplifier to an external device (for example: a Power amplifier etc.): using RCA-RCA interconnect cables connect it to the Analog RCA Output (MONO OUT).
- If you want to broadcast voice using a microphone (not supplied with this product) connect it to the Microphone 1/4" Jack Input on the front or rear of the amplifier.
- External audio equipment connection options:

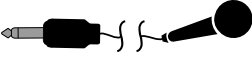
TCA Input / Output	Audio equipment Input / Output	Connection Cable
LINE1 input 	Output - RCA sockets 	RCA-RCA interconnect (not supplied) 
LINE2 input 	Output - RCA sockets 	RCA-RCA interconnect (not supplied) 
LINE3 input 	Output - RCA sockets 	RCA-RCA interconnect (not supplied) 
MONO OUT output 	Input - RCA sockets 	RCA-RCA interconnect (not supplied) 
MIC1 6.35 mm (1/4") input 		6.35 mm jack interconnect (not supplied) 
MIC2 6.35 mm (1/4") input 		6.35 mm jack interconnect (not supplied) 

The sockets and ports shown for external equipment and connection options may differ depending on the device.

- Your amplifier is ready for operation.

Note! This amplifier is a mono device - Left and Right input signal in the LINE inputs is mixed together.

Operation

1. Plug the Power Cable into the electrical outlet.
2. Switch on the amplifier – press the Power Switch (the Power Switch should be in the 1 position). The ON Power Status LED should turn on in a few seconds. If it does not, it means that the amplifier is working under an abnormal condition (a protection mode) – turn off the power, unplug the Power Cable and check whether some of the cables are not short circuited. After fixing the cables turn the amplifier on.
3. Switch on your audio source and start playback.



- Distortion and sound quality worsening may occur when below regulators (knobs) are in the maximum position. It may damage the amplifier or speakers. This may void your warranty.
- High volume levels can damage this amplifier or speakers. This may void your warranty.

ZONE VOLUME Regulators:

Available only for the Zone Output connection option.

For each ZONE you can adjust the sound volume from minimum (the knob – max counterclockwise) to maximum (the knob – max clockwise).

LINE Input Mixing Regulators (LINE1, LINE2 etc.):

Adjust the sound / mixing level input for connected audio source devices: mix and fade-in / fade-out.

Turn the selected LINE knob clockwise (+) to make the sound of this line more audible (fade-in) and counterclockwise (-) to make it less audible (fade-out).

Minimum (the knob – max counterclockwise : the marker on the knob shows 0) – no audio signal is transmitted from this line input.

Additional Speaker Output Connection option - in this option the LINE regulators control the output level of the Additional Speaker Output. The ZONE VOLUME regulators are not active.

TREBLE Regulator:

You can adjust treble output of the amplifier.

The default: the knob is in the center position : the marker on the knob in the vertical position (0). Turn the knob counterclockwise (-) to decrease the amount of high frequencies. Turn the knob clockwise to increase the amount of high frequencies (+)

The regulation will affect all speaker outputs and the Analog RCA Output (MONO OUT).

BASS Regulator:

You can adjust bass output of the amplifier.

The default: the knob is in the center position : the marker on the knob in the vertical position (0). Turn the knob counterclockwise (-) to decrease the amount of low frequencies. Turn the knob clockwise (+) to increase the amount of low frequencies (+).

The regulation will affect all speaker outputs and the Analog RCA Output (MONO OUT).

Operation

MICROPHONE

This amplifier allows a connection of one or more wired microphones (the number of microphone inputs depends on a model) and easy voice mixing with the background music and broadcasting voice announcements.

Microphone Mixing Regulators

Adjust the sound / mixing level input for connected microphones: mix and fade-in / fade-out.

Turn the selected microphone knob clockwise (+) to make the sound of this microphone more audible (fade-in) and counterclockwise (-) to make it less audible (fade-out).

Minimum (the knob – max counterclockwise : the marker on the knob shows 0) – no audio signal is transmitted from this microphone input.

MIC2 Priority

The front panel microphone input (MIC2) has a priority over all other active inputs (LINE and MIC)- when it is used all active inputs are muted.

Note! The signal from the microphone(s) will be broadcasted to all active outputs (Additional Speaker Output or Zone Outputs) and to the Analog RCA Output (MONO OUT).

CHIME - Voice Announcement Button

Pressing this button will mute all active LINE inputs and activate sound chimes for a short period of time to notify that a voice announcement is to be broadcasted – afterwards all active LINE inputs will be recovered. When the CHIME button is pressed the CHIME Status LED Indicator will be illuminated.

MONO OUT

This output can be used to record audio from the amplifier on an external device or to connect other external devices. The output audio signal level is fixed (is not regulated by the Volume Regulator).

The treble / bass regulation will affect this output.

Note! This amplifier is a mono device - Left and Right output contain the same audio signal.

SIG – Signal Status LED Indicator

Once the input audio signal is received by the amplifier this indicator will be flashing.

CLP – Clipping Status LED Indicator

Once this indicator starts flashing it means that the signal is overloaded turn down the level of the volume and/or line inputs.

We strongly advise to contact a professional installer or dealer in order to install TAGA Harmony products.

We recommend using high quality TAGA Harmony cables and other installation accessories.

Kit Content:

Amplifier	1EA
Instruction Manual	1EA

EU declaration of conformity

	<p>Your product is marked with the symbol shown on the left. As its manufacturer, hereby we declare that the product is in compliance with the following EU directives and regulations: 2014/30/EU (EMC) & 2014/35/EU (LVD) & 2014/53/EU (RED) & 2011/65/EU (RoHS)</p> <p>The full text of the EU declaration of conformity is available from the manufacturer.</p>
---	---

Disposal of the product

	<p>Disposal of old electrical & electronic equipment (applicable in the European Union and other countries with separate collection systems)</p> <p>This symbol on the product or on its literature and packaging indicates that this product shall not be treated as household waste. Instead it shall be handed over to the appropriate collection point for the recycling of electrical and electronic equipment. By ensuring that this product is disposed of correctly, you will help to prevent potential negative consequences for the environment and human health, which could be caused by inappropriate waste handling of this product. The recycling of materials will help to conserve natural resources. For more detailed information about recycling of this product, please contact your local government office, your household waste disposal service or the shop where you purchased the product.</p>
--	--

TAGA EUROPE
POLPAK POLAND Sp. z o.o.
AL.JERZOLIMSKIE 331A
05-816 REGULY k/WARSZAWY, POLAND
Email: Sales@TagaHarmony.com

www.TagaHarmony.com

Notes

Notes
