

# Instruction manual



SMART  **CHARGER** **100A**  
AUTOCONTROL **130A**  
**DYNAMIC**



The installation of this product must be made by a qualified professional.



[www.taramps.com.br](http://www.taramps.com.br)

# Índex

- 01 • Warranty term
  - Technical support
- 02 • Introduction
  - Presentation
  - Important recommendations
- 03 • Electrical network connections
- 04 • Output & power connector
- 05 • Led indicators & protection system
- 06 • Operation mode
  - Battery recharges & amplifier powering
- 07 • Technical features

## Warranty term

TARAMPS, located at Júlio Budisk highway, SN, KM 30 – Alfredo Marcondes, SP - Brazil, ZIP CODE 19180-120, warrants this product against any defects on terms of project, making, assembling, and/or with solidarity, due to project vices which cause it improper or inadequate to its original use within 12 months from the date of purchase. In case of defect during the warranty period, TARAMPS responsibility is limited to the repairing or replacement of the device of its own making.

### **This warranty excludes:**

- Damaged products by improper installation, water infiltration, violation by unauthorized individuals;
- Tamper or torn warranty seal;
- Cases in which the product is not used in adequate conditions;
- Defects caused by accessories, modifications or features attached to the product;
- The product with damage from falling, bumps or nature related problems (flooding, lightning, etc);
- Warranty card is not properly filled or torn;
- Costs involving uninstallation, reinstallation of equipment as well the shipment to the factory;
- Damage of any kind, due to problems in the product, as well as losses caused by discontinued use of the product;

## Technical assistance

For international support, check on our website:

[www.taramps.com.br/en/rede-de-assistencias-tecnicas](http://www.taramps.com.br/en/rede-de-assistencias-tecnicas) or contact direct the factory support:

Phones: +55 18 3266-4050 / +55 18 99749-3391

E-mail: [service@taramps.com.br](mailto:service@taramps.com.br)

# Introduction

Congratulations on your purchase of a Taramps product. Designed in a modern laboratory, with the highest technology and highly qualified professionals. This manual explains all features, operations, and guidelines to answer questions that may arise during your installation. Please take the time to read it carefully to ensure proper installation and use of all the benefits this product can offer. If there is any question after reading this manual, contact our technical support at the phone number +55(18)-3266-4050 or through our website [www.taramps.com.br](http://www.taramps.com.br).

## Presentation

The SMART CHARGER Power Supply / Charger features high technology and smart and efficient features for RECHARGING batteries and/or POWERING a car sound system. Highlighting:

**DYNAMIC:** This mode, the power supply provides up to 130A while with music signal at its output. With this, the system will have 30% more power compared to a standard 100A power supply. (This function is activated automatically).

### SMART MODE:

- Automatic detection of the load characteristics connected to its output. In case it has batteries, the device analyzes their characteristics and conditions and recharges them seeking the best performance. If the battery charge level is critical, the power supply automatically adjusts the output current, smartly charging the batteries.
- When charging the batteries, the power supply periodically oscillates between voltages 14.4V / 13.8V / 12.6V; doing the battery float and equalize cycles. This process decreases the internal heat of the batteries, improving charge retention efficiency.
- When used only as a power supply (without batteries) the power supply output can be set as 12.6V, 13.8V or 14.4V.
- During battery recharge, if the audio system is turned on, the power supply automatically identifies the need for charging and adjusts its output to 14.4V. If no more output variations are identified, the source returns to the smart charging system or float.
- Output short circuit protection. **WARNING: NEVER REVERSE POLARITY.**

## Important recommendations

- 1- Never use extensions with a gauge smaller than the recommended. Make sure that the socket and the electrical network can handle the necessary current to power the power supply (see page 03 / 04).
- 2- The Smart Charger 100A has an "automatic bivolt" system - it automatically recognizes the voltage of the electrical network and adjusts itself to it. For the power supply to have the expected performance, the outlet voltage must be above 90V (127V network) or above 190V (220V network).
- 3- Install the power supply in a firm and well-ventilated place. Never install it on the sides of speaker boxes, due to vibration.
- 4- The power supply has no user-serviceable internal parts. Do not open it, risk of electric shock.
- 5- If the power supply is not going to be used for a long period, we recommend unplugging it from the power outlet.
- 6- Do not install the power supply in a place with direct exposure to sunlight.

## Safety warnings

As you read this manual, pay attention to the safety warning symbols.

### CAUTION

The "Caution" symbol is intended to alert the user to important instructions. Failure to follow instructions could result in risk to the user or damage to the product.



Taramps reserves the right to change the content of this manual without prior notice or obligation to apply the modifications to previously produced units.

# Electrical network connections

**OUTLET:**The socket must be sized to withstand the maximum current drawn by the power supply.

## **⚠ CAUTION**

The user must check if the outlet/ power board is suitable for installing the product according to the usage voltage.

If the electrical installation is not adequate, the performance and efficiency of the power supply will be compromised.

We recommend that the electrical installation be carried out by a qualified professional.

**EXTENSION CORD:** (Optional, not included with the product).

Do not use extension cords with gauges smaller than the recommended:

127V: \_\_\_\_\_ 4mm<sup>2</sup> (11 AWG)

220V: \_\_\_\_\_ 2,5mm<sup>2</sup> (13 AWG)

Maximum length of 10 meters.

**➡ IMPORTANT:** Any connection to the power supply must be made with the equipment off.

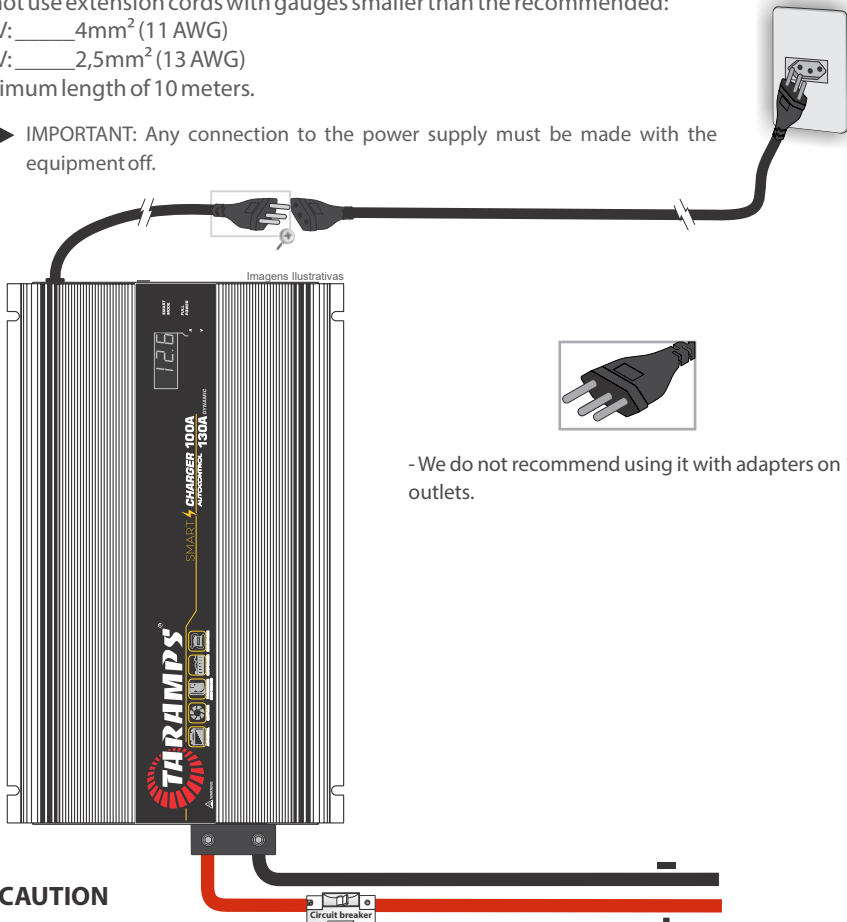

- We do not recommend using it with adapters on 10A outlets.

## **⚠ CAUTION**

### **BATTERY CABLES:**

Do not use cables with gauges smaller than recommended:

It is indispensable to install a circuit breaker near the power supply.

Cable: 16mm<sup>2</sup> (5 AWG)

Circuit Breaker: 150A

# Output & power connector

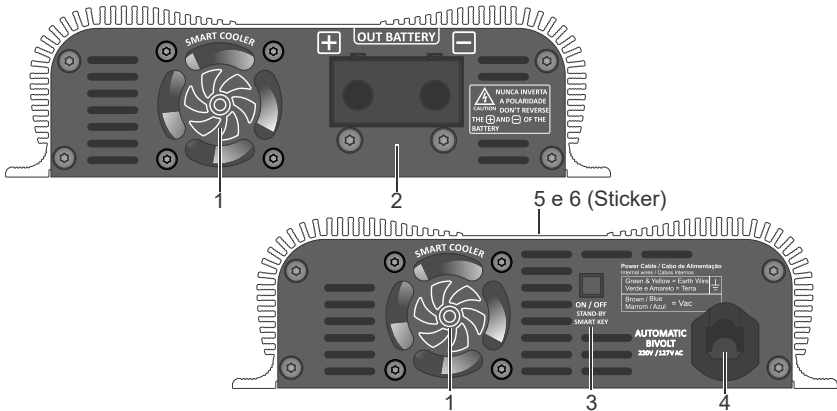

**1 - SMART COOLER:** An intelligent system that controls the operation of coolers and ventilation, varying their speed according to temperature and output current. This system ensures a longer lifespan for the coolers and provides a quieter ambient as the coolers only come into operation only if necessary.

Note. If the power supply is turned off (but kept connected to the outlet) and its temperature is high, the SMART COOLER can be activated at low speed for up to 20 minutes.



## CAUTION

The fans and ventilation openings are responsible for cooling the power supply when it is in use, so it cannot be obstructed.

**2 - OUT BATTERY:** To connect the positive (+) and negative (-) cables to the battery or 12 Volt equipment.

(See recommended gauges on page 03).

IMPORTANT: Never reverse polarity. Connect the battery(ies) and audio system with the power supply off.



## CAUTION

Before making any connections to the battery(ies), make sure you have the correct polarities.

**3 - SMART KEY (ON/OFF):** This button turns the power supply on and off. With the power supply turned off, a quick press (1 second) turns the power supply on.

With the power supply on, a long press (2 seconds) turns the power supply off. A quick press change the output voltage: 12.6 → 13.8 → 14.4 → 12.6V... (Without batteries).

Note. If the power supply is disconnected from the outlet while being turned on, when reconnecting Versions manufactured from **10/2025** onwards have a Smart Key (short press) that allows switching between the following modes: 14.4V Fixed (**factory version**) > 13.6V Fixed > 12.6V Fixed > Smart Mode > 14.4V Fixed >...

It to the outlet, the power supply will be turned on. Through this key it is possible to set the operation mode with fixed voltage of the power supply.

See operating mode on page 06.

**4 - POWER INPUT:** Power cable with 10A plug.

The SMART CHARGER is automatic bivolt (127V / 220V).









Check the recommended power input specifications on page 03.

**5 - VOLTMETER/AMMETER:** Display the output voltage and current, alternating between them. In the event of a sudden change in the voltage, the display blink. With the power supply OFF, this display can be ON during 5 seconds. There may be up to 5% error on voltage reads and 20% on current reads.

**6 - SMART LED:** Power supply functions indicator LEDs.

# LED indicators & protection system

**ILLUMINATED LOGO (Smart LEDs):** When turned on or when changing operating modes, the LOGO displays the current status.

Smart LEDs		Conditions: Operating mode
 4x	LEDs Flashing 4x	Fixed 14.4V mode
 3x	LEDs Flashing 3x	Fixed 13.8V mode
 2x	LEDs Flashing 2x	Fixed 12.6V mode
	LEDs flashing rapidly	Smart Mode (The power supply automatically manages all output voltage and current settings). Suitable for intelligent battery recharging.
Smart LEDs		Conditions: Protections
 2x	LEDs Flashing 2x	Critical battery level detected (<6V) connected to the power supply output.
 3x	LEDs Flashing 3x	Battery at very high level detected (>16V) connected to the power supply output.
 6x	LEDs flashing 6x per second and continuously	A short circuit was detected at the power supply output. The power supply automatically re-checks the output every 5 seconds.
	LEDs flashing, 1 second on and 1 second off	Over-temperature protection activated. The power supply shuts off the output and waits for the internal temperature to drop.



**SMART  
MODE**

**LED SMART MODE:** Show that the power supply is in SMART MODE.

When blinking fast, batteries are recharging, and when this led is on the batteries recharge is completed.

If the LED is blinking slowly, the battery has been disconnected or the health of the battery may be compromised.



**FULL  
POWER**

**LED FULL POWER:** Is on when in power supply mode, or when is recharging and identifies the need of full power on this output.

## Battery recharges and amplifier powering

In this case, in addition to recharging the batteries, the **Smart Charger 100A** power supply acts as an auxiliary to the batteries in powering the amplifiers.

The Intelligent Charging System analyzes and monitors battery status and amplifier power/consumption.

The power supply can be used to recharge various types of 12V battery capacities. For the SMART CHARGER 100A version, the best performance is obtained for recharging batteries (or battery bank) between 60Ah and 1500Ah nominal capacity.

The power supply's SMART functions aim to optimize battery recharging by applying slow charging when needed and automatically switching between charge, float, and battery equalization modes. In addition, the power supply constantly monitors its output and identifies when an amplifier is consuming a high load, thus requiring the maximum power of the power supply "power supply Mode".

## Connection example

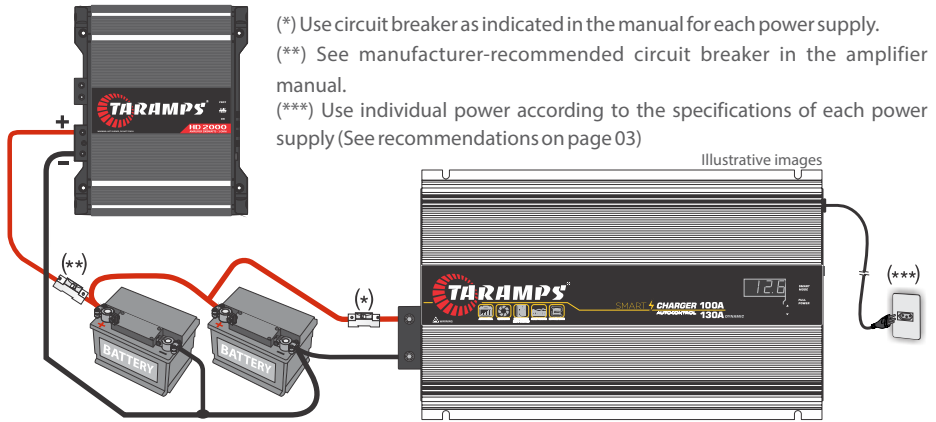

## Operation mode:

**SMART MODE:** The power supply manages all the output voltage and current settings automatically.

- ▶ **TURN THE POWER SUPPLY ON:** The main analysis take place at this stage;  
Automatic battery analysis. Without battery ,the output voltage can be selected as 12.6, 13.8 and 14.4V.
- ▶ **ANALYSIS OF BATTERY CONDITIONS:**
  - constant voltage (V) cycle load.
  - constant current (I) cycle load.
- ▶ **BATTERY:**
  - **Low Charge** → Cycles: I constant → V constant → Flut./EQ.
  - **Good Charge** → Cycles: V constant → Flut./EQ.
- ▶ **DYNAMIC MODE- No battery:**
  - Once turned on and the battery NOT connected is identified, the power supply will indicate by the **FULL POWER LED** and will already have the **DYNAMIC MODE** activated. The voltage can be changed by the **SMART KEY**.
- ▶ **DYNAMIC MODE - With battery:**
  - As soon as it is turned on and the connected battery is identified, the power supply will indicate by the flashing **SMART CHARGER LED** and the battery(ies) will be charging intelligently. When the power supply identifies a higher consumption, the function is changed to **FULL POWER MODE** and will already have **DYNAMIC MODE** activated.

**FIXED VOLTAGE MODE:** It is possible to fix the power supply output voltage and disable the SMART functions. To do this, with the power supply turned off, press the SMART KEY key for 15 seconds. Smart LEDs will display the configuration. After that, every time you press (1S) the SMART KEY, the mode is changed following this sequence: SMART > 12.6V > 13.8V > 14.4V... To save the configuration, press and hold the SMART KEY key for 2 seconds

## Technical features

Voltage Supply:	Bivolt Automatic (127 / 220VAC)
127V Network Voltage Range:	90 ~ 140V AC
220V Network Voltage Range:	190 ~ 250V AC
Rated Max. Output Current(*):	100A 130A* Dynamic
Maximum Output Power:	1850W
Average Efficiency:	90%
Max. Consumption on 127V Network:	22A
Max. Consumption in 220V Network:	14A
Max. Input Power:	3000VA(***) or 2000W (FP: ~0.58 capacitive)
Consumption in Stand by (off, but connected to the outlet):	3W
Maximum Float at full load (130A @14.2V):	<2%
Input Fuse (internal):	20A
Output Voltages:	12,0V ~ 14.5V (**)
Dimensions(W x H x D):	182 x 52 x 319mm (7.17" x 2.05" x 12.56")
Weight:	2.30Kg (5.06lb)

•**Short Protection:** Temporarily shuts off the output if a short circuit is detected.

•**Thermal protection:** Reduces the output power if the internal temperature rises, automatically returning to full power as the temperature drops.

Note:

(\*) Rated output current, measured with resistive load, source output voltage = 12.6V and mains voltage = 127V / 220V.

Dynamic Function: This function allows the battery charger to supply a current greater than the rated current for a period of time of up to 4 seconds.

(\*\*) Variable voltage depending on the operating mode, and may have values lower than 12.0V when in slow load or thermal protection.

(\*\*\*) For use with generators, consider the power in VA.



+55 18 3266-4050

Manufactured by:  
TARAMPS ELECTRONICS LTDA  
Tax ID: 11.273.485/0001-03  
Júlio Budisk Rd, SN, KM 30  
Alfredo Marcondes - SP  
Made in Brazil  
[www.taramps.com.br](http://www.taramps.com.br)