

# INSPIRE GREATNESS

For more information on how to use the tablet, please go to [tcl.com](http://tcl.com) and download the complete user manual. Moreover, on the website you can also find answers to frequently asked questions.



**TCL** TAB 10<sub>L</sub>  
Gen2

# 1 Table of Contents

<b>1</b>	<b>Your device</b> .....	<b>4</b>
1.1	Keys and connectors.....	4
1.2	Getting started .....	7
1.3	Home screen.....	8
<b>2</b>	<b>Text input</b> .....	<b>17</b>
2.1	Using the onscreen keyboard .....	17
2.2	Text editing.....	18
<b>3</b>	<b>Contacts</b> .....	<b>19</b>
3.1	Contacts.....	19
<b>4</b>	<b>Calendar, Clock, and Calculator</b> .....	<b>24</b>
4.1	Calendar .....	24
4.2	Clock.....	26
4.3	Calculator.....	28
<b>5</b>	<b>Multimedia applications</b> .....	<b>29</b>
5.1	Camera .....	29
5.2	Photos .....	30
<b>6</b>	<b>Others</b> .....	<b>33</b>
6.1	Support Centre.....	33
6.2	Other applications .....	33
<b>7</b>	<b>Google applications</b> .....	<b>34</b>
7.1	Chrome.....	34

7.2	Gmail.....	34
7.3	Maps .....	35
7.4	YouTube.....	35
7.5	Play Store.....	35
<b>8</b>	<b>Settings.....</b>	<b>36</b>
8.1	Network and Internet.....	36
8.2	Connected devices.....	39
8.3	Apps.....	42
8.4	Notifications .....	42
8.5	Battery .....	42
8.6	Storage .....	42
8.7	Sound.....	42
8.8	Display.....	43
8.9	Wallpaper .....	43
8.10	Accessibility.....	43
8.11	Security .....	43
8.12	Privacy.....	45
8.13	Location .....	45
8.14	Safety & emergency.....	46
8.15	Password and accounts.....	46
8.16	Digital Wellbeing and parental controls....	46
8.17	Google.....	47
8.18	DuraSpeed.....	47
8.19	System.....	47

8.20	About tablet.....	48
<b>9</b>	<b>Making the most of your tablet.....</b>	<b>49</b>
9.1	FOTA Upgrade.....	49
<b>10</b>	<b>Accessories .....</b>	<b>50</b>
<b>11</b>	<b>Troubleshooting.....</b>	<b>51</b>
<b>12</b>	<b>Specifications .....</b>	<b>57</b>

# 1 Your device.....

## 1.1 Keys and connectors

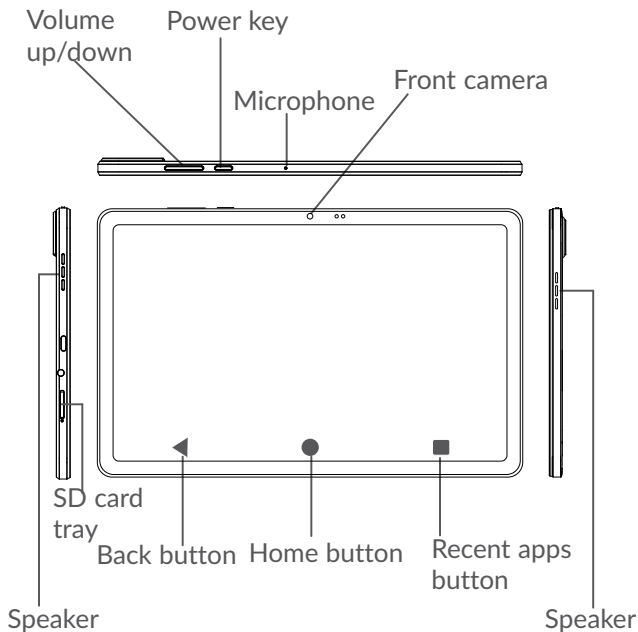

Back camera

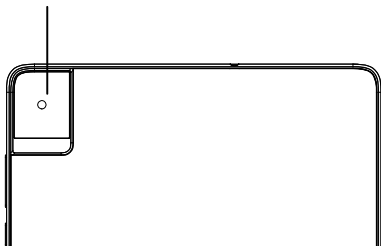

### **Back button**

- Touch to go back to the previous screen, or close a dialog box, options menu, the Notification panel, etc.



### **Home button**

- From any application or screen, touch to return to the Home screen.
- Long press to turn on Google Assistant. You can get help such as getting directions and restaurant information based on the content detected on the screen.



### **Recent Apps button**

- Touch to view applications you've recently accessed.

## Power key

- Press: Lock the screen/Light up the screen.
- Press and hold: Show the popup menu to select from **Power off/Restart**
- Press and hold the **Power** key and **Volume down** key to take a screenshot.
- Press and hold the **Power** key for at least 10 seconds to force reboot.

## Volume keys

- Adjust the media volume while listening to music or a video, or streaming content.
- While using the **Camera** app, press **Volume up** or **down** key to take a photo.

## 1.2 Getting started

### 1.2.1 Setting up

Insert or remove your microSD card.

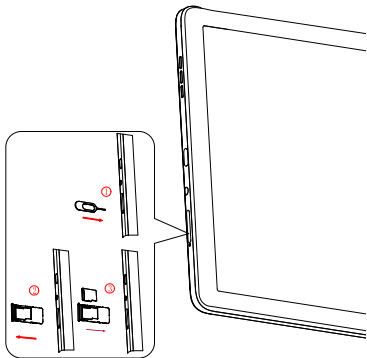

Charging the battery

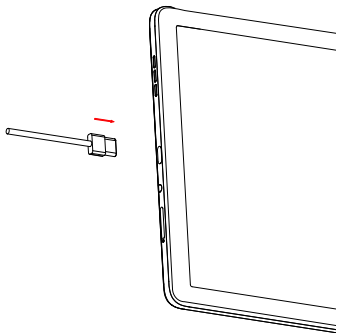

You are advised to fully charge the battery (  ). Charging status is indicated by a percentage displayed on screen. The percentage increases as the tablet is charged.



To reduce power consumption and energy waste when the battery is fully charged, disconnect your charger from the plug; switch off Wi-Fi, Bluetooth or background-running applications when not in use; reduce the backlight time, etc.

## 1.2.2 Powering on your tablet

Hold down the **Power** key until the tablet powers on, unlock your tablet (Swipe, PIN, Password or Pattern) if necessary and confirm. The Home screen is displayed.

## 1.2.3 Powering off your tablet

Press and hold the **Power** key until options appear, then select **Power off**.

## 1.3 Home screen

You can bring all the items (applications, shortcuts, folders and widgets) you love or use most frequently to your Home screen for quick access. Touch the **Home** button to switch to the Home screen.



## 1 Status bar

- Status/Notification indicators
- Swipe down to open the Notification panel.

## 2 Favorite tray applications

- Enter the application.
- Long press to move or remove applications.

## Auto-rotate screen

From the app list, touch **Settings** > **Display** > **Auto-rotate screen** to enable the function.

### 1.3.1 Using the touchscreen

Touch 

To access an application, touch it with your finger.

## Long press



To enter the available options for an item, long press the item. For example, select a contact in Contacts, long press this contact, an option list will appear.

## Drag



Long press an item and drag it to another location.

## Slide/Swipe



Slide the screen to scroll up and down the applications, images, and web pages. You can slide the screen horizontally too.

## Flick



Similar to swiping, flicking is a lighter and quicker stroke.

## Pinch/Spread



Place two fingers on the screen surface and draw them apart or together to scale an element on the screen.

The tablet also supports one finger zooming in Photos. Double touch the screen to zoom in/out.

## Rotate



Automatically change the screen orientation from portrait to landscape by turning the tablet sideways to have a better screen view.

## 1.3.2 Status bar

From the Status bar, you can view both tablet status (on the right side) and notification information (on the left side).

Swipe down the status bar to view notifications and swipe down again to enter the Quick settings panel. Swipe up to close it.

### Notification panel

Swipe down the Status bar to open the Notification panel to read detailed information. Hold the notification panel and swipe it up to find Clear all button.



Clear all notifications (ongoing notifications will remain)

## Quick Settings panel

Swipe down the Status bar twice to access the Quick Settings panel where you can enable or disable functions or change modes by tapping the icons

Touch to open **Settings**, to view the full list of settings.



### 1.3.3 Locking and unlocking your screen

To protect your tablet and privacy, you can lock the tablet with a pattern, PIN, or password, etc.

#### To create a screen unlock pattern

- From the Home screen, touch **Settings > Security > Screen lock**.
- Set your own pattern.

## To lock tablet screen

If your tablet remains inactive for a period of time, it will automatically lock the screen and enter sleep mode to save power. Go to **Settings > Display > Screen timeout** and select a screen timeout period. You can also manually lock the screen by pressing the Power key once.

## To unlock the tablet screen

Press the **Power** key once to light up the screen, swipe up and unlock the screen with the method you have set.

If you have chosen **Swipe** as the screen lock, you can press the **Power** key to light up the screen, then swipe up to unlock the screen.



Swipe up to  
unlock the screen

## 1.3.4 Personalising your Home screen

### Add

You can long press a folder, an application or a widget and drag the item to your preferred Home screen.

### Reposition

Long press an item and drag it to the desired position and then release. You can move items both on the Home screen and the Favourite tray. Hold the icon on the left or right edge of the screen to drag the item to another Home screen.

### Remove

Long press an item and drag it up to the top of the **Remove** icon, then release.

### Create folders

To improve the organisation of shortcuts or applications on the Home screen and the Favourite tray, you can add them to a folder by stacking one item on top of another. To rename a folder, open it and touch the folder's title bar to input the new name.

### Wallpaper customisation

Long press an empty area on the Home screen, then touch **Wallpaper & style** to customise wallpaper.

## 1.3.5 Widgets and recently used applications

### Consult widgets

Long press the empty area on the Home screen, then touch **Widgets** to display all widgets.

Touch the selected widget and slide it to move to your preferred screen.

### Consult recently used applications

To consult recently used applications, touch the **Recent Apps** button . Touch a thumbnail in the window to open the application.



Touch one thumbnail and slide it up to close an application.

Touch **Clear all** at the bottom of screen to close all the running applications.

## 1.3.6 Volume adjustment

### Using the volume key

By default, press the **Volume** key to adjust the **Media** volume. To mute the sound, press **Volume Down** key until the icon  appears.

### Using the settings menu

From the Home screen, touch **Settings** > **Sound** to set the volume for media, notification, alarm, etc.

# 2 Text input.....

## 2.1 Using the onscreen keyboard

### Onscreen keyboard settings

Go to **Settings > System > Languages and input > On-screen keyboard**, touch the keyboard you want to set up and a series of settings will become available.

### Adjust the onscreen keyboard orientation

Turn the tablet sideways or upright to adjust the onscreen keyboard orientation. You can adjust it by changing the settings (Touch **Settings > Display > Auto-rotate screen**).

### 2.1.1 Gboard



- 1 Enter text or numbers.
- 2 Long press to select symbols.

- 3 Switch between "abc/Abc" mode; Press twice quickly to switch to "ABC" mode always.
- 4 Switch between symbol and numeric keyboard.

## 2.2 Text editing

You can edit the texts which you have entered.

- Long press or double tap within the texts you want to edit.
- Drag the tabs to change the selected texts.
- The following options will appear: **Cut**, **Copy** and **Share** .
- If you have previously cut or copied any text, touch the tab to show **Paste** which allows you then paste the text at the current location.

# 3 Contacts .....

## 3.1 Contacts.....

**Contacts** enables quick and easy access to the contact you want to reach.

You can view and create contacts on your tablet and synchronise them with your Gmail contacts or other applications.

### 3.1.1 Consult your Contacts

To see your contacts, touch  from the App drawer.



- 1 Display the contacts list option menu
- 2 Touch to search contacts
- 3 Long press to select contact(s) to delete
- 4 Add new contact



Deleted contacts will also be removed from other applications on the tablet or web the next time you synchronise your tablet.

### 3.1.2 Adding a contact

Touch  in the contact list to create a new contact.

You are required to enter the contact's name and other contact information. By scrolling up and down the screen, you can move from one field to another.



- 1 When finished, touch this icon to save
- 2 Select a picture or take a photo for the contact
- 3 Touch to open available labels

## Add to/Remove from Favourites <sup>(1)</sup>

To add a contact to favourites, you can touch a contact to view details then touch  to add the contact to favourites.

To remove a contact from favourites, touch  on the contact details screen.

### 3.1.3 Editing your contacts

To edit contact information, touch  in the contact details screen.

When finished, touch **Save** to save.

### 3.1.4 Importing, exporting and sharing contacts

This tablet enables you to import contacts from your internal storage to your tablet, and export your tablet contacts via a .vcf file for sharing with others.

#### To import contacts:

From the Contacts screen, tap **Fix & manage > Import from file**, then select contacts file to import.

<sup>(1)</sup> Only tablet contacts and account contacts can be added to Favourites.

## To export and share contacts:

From the Contacts screen, tap **Fix & manage** > **Export to file**, and enter a name for vcf file for future use, then tap **Save**, the contacts will be automatically exported.

You can share a single contact or contacts with others by sending the contact's vCard to them via Bluetooth, Gmail.

Touch and hold a contact you want to share, touch  Share on contact details screen, and then select the application to perform this action.

### 3.1.5 Displaying contacts

Touch **Fix & manage** and then **Settings**, select **Sort by** > **First name** or **Surname** to sort the contacts list. as well as viewing contact names by **First name first** or **Surname first** through the **Name format** menu.

### 3.1.6 Synchronising contacts in multiple accounts

Contacts, data or other information can be synchronised from multiple accounts, depending on the applications installed on your tablet.

To add an account, touch **Fix & manage** from the contacts list and touch **Settings** > **Accounts**, or from the app list, then **Settings** > **Accounts** > **Add account**.

You are required to select the kind of account you are adding, like Exchange and Google.

As with other account setups, you need to enter detailed information, like username, password, etc.

You can remove an account and all associated information from the tablet. Touch the account you want to delete > Select **REMOVE ACCOUNT**.

### **Auto-sync**

On the **Accounts** screen, touch **Automatically sync app data**, when activated, all changes to information on the tablet or online will be automatically synchronised with each other.

# 4 Calendar, Clock, and Calculator .....

## 4.1 Calendar

You can use **Calendar** to keep track of important meetings, appointments, etc.

To view the calendar and create events, open Google apps folder from Home screen, then touch **Calendar**.

### 4.1.1 Multimode view

You can display the Calendar by **Schedule**, **Day**, **3 Days**, **Week**, or **Month**, touch  to select.

### 4.1.2 To create new events



You can add new events from any Calendar view.

- Touch .
- Fill in all required information for this new event. If it is a whole-day event, you can select **All-day**.
- Invite guests to the event. Enter the email addresses of the guests you want to invite with commas to separate. The guests will receive an invitation from Calendar and Email.

- When finished, touch **Save** from the top of the screen.

To quickly create an event from the Week view screens, touch an empty spot to select a target area which will then turn , then touch the icon to create the new event.

### 4.1.3 To delete or edit an event

To delete or edit an event, touch the event to enter its details screen. Touch  to edit the event, or touch  and then **Delete** to delete.

### 4.1.4 Event reminder

If a reminder is set for an event, the upcoming event icon  will appear on the Status bar as a notification when the reminder time arrives.

Swipe down the Status bar to open the Notification panel and touch an event name to view the Calendar notification list.

## 4.2 Clock

Your tablet has a built-in clock. swipe up the Home screen, then touch **Clock**.

### 4.2.1 Clock

To view the world clock, touch **Clock** on the Time screen.

Touch  to add a time zone.

### 4.2.2 Alarm

From the Clock screen, touch **Alarm** to enter the **Alarm** screen.

Turn on  to enable the alarm.

Touch  to add a new alarm:

Touch a currently existing alarm to enter the alarm editing screen.

Touch  to delete the selected alarm.

## 4.2.3 Timer

From the Clock screen, touch **Timer** to enter the **Timer** screen.





- Select the time.
- Touch  to start the countdown.



Pause/play

## 4.2.4 Stopwatch

From the Clock screen, touch **Stopwatch** to enter the **Stopwatch** screen.

- Touch  to start the Stopwatch.
- Touch  to show a list of records according to the updated time.
- Touch  to halt the total and lap times. These will only restart after  is touched.
- Touch  to delete the record.

## 4.2.5 Adjust Clock settings

Touch  and then **Settings** to access **Clock**, **Alarms**, **Timer** and **Screensaver** settings.

## 4.3 Calculator

To solve mathematical problems with Calculator, swipe up from the home screen, then touch Calculator.

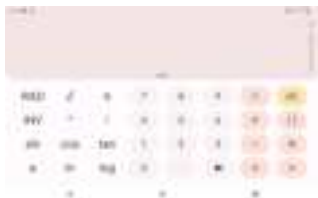

Touch  to delete all at once.

# 5 Multimedia applications.....

## 5.1 Camera

Before using the camera, make sure that you remove the protective lens cover to avoid it affecting your picture quality.

To take a photo or video, touch  from the Home screen.







- 1 Switch between front and rear camera
- 2 Spread fingers apart to zoom in, or pinch fingers together to zoom out
- 3 View the photos or videos you have taken
- 4 Take a photo
- 5 Change to video mode

## To take a photo

Touch **Picture** to capture. The photo will be automatically saved. You can also long press  to take burst shots.

## To take a video

Touch **Video** to change the camera mode to video, then touch  to start video recording. You can also touch the left icon  to take a picture during video recording.

Touch  to pause video recording and touch  to continue. Touch  to stop recording. The video will be automatically saved.

## 5.2 Photos

Photos act as a media player for you to view photos and play videos. In addition, a set of further operations to pictures and videos are available for your choice.

To view the photos you have taken, slide up from the Home screen, then touch **Photos**.

Pictures and videos are displayed by albums.



Select photos for further operation.

## Working with pictures

Find the picture you want to work on, and touch the picture to enter the full-screen picture view.

Touch  to share the picture.

Touch  to delete this picture.



Tap  to use Google lens to analyze the photo and deliver search results.

Touch  select **Use as** to set the picture as Contact photo or Wallpaper.

Tap  to edit the picture or video.

## Batch operation

The Photos provide a multi-select function, so that you can work with pictures/videos in batches.

On **Photos** screen, long press a picture or video to activate batch operation mode, then touch videos/pictures you want to work with. Touch  to delete selected files. Touch  to share selected files.

# 6 Others.....

## 6.1 Support Centre

**Support Centre** helps you to learn more about Hot FAQs, operation instructions, troubleshooting, etc. You can also feedback your comments to us through it.

## 6.2 Other applications <sup>(1)</sup>

The previous applications in this section are preinstalled on your tablet. To read a brief introduction of the preinstalled 3rd party applications, refer to the leaflet provided with the tablet. To download and install more 3rd party applications, use the Google Play Store application.

<sup>(1)</sup> Application availability depends on country and operator.

# 7 Google applications .....

Google apps are preinstalled on your tablet to improve work efficiency and help you enjoy life.

This manual briefly introduces the apps. For detailed features and user guides, refer to related websites or the introduction provided in the apps.

You are recommended to register with a Google account to enjoy full functionality.

## 7.1 Chrome

A web browser with which you can surf the internet.

Your bookmarks, browsing history, and settings across all devices on which the browser is installed can be synchronised with your Google account.

## 7.2 Gmail

As Google's web-based email service, Gmail is configured when you first set up your tablet. With this application, you can send and receive emails, manage emails by labels, archive emails, etc. Emails can be automatically synchronised with your Gmail account.

## 7.3 Maps

Google Maps offers satellite imagery, street maps, 360° panoramic views of streets, real-time traffic conditions, and route planning for traveling by foot, car, or public transportation. By using this application, you can get your own location, search for a place, and get suggested route planning for your trips.

## 7.4 YouTube

YouTube is an online video-sharing application where users can upload, view, and share videos. Available content includes video clips, TV clips, music videos, and other content such as video blogging, short original videos, and educational videos. It supports a streaming function that allows you to start watching videos almost as soon as they begin downloading from the internet.

## 7.5 Play Store

Serves as the official app store for the Android operating system, allowing users to browse and download applications and games. Applications are either free of charge or at a cost.

In Play Store, search for the app you need, download it and then follow the installation guide to install the app. You can also uninstall, update an app, and manage your downloads.

# 8 Settings.....

To go to Settings, swipe up from the Home screen and touch **Settings**.

You can also swipe down from the notification panel and touch .

## 8.1 Network and Internet

### 8.1.1 Wi-Fi

You can connect to the internet when your tablet is within range of a wireless network.

**To turn Wi-Fi on and connect to a wireless network**

- Touch **Settings > Network and Internet > Internet**.
- Turn on Wi-Fi .
- Once Wi-Fi is turned on, detected Wi-Fi networks are listed.
- Touch a Wi-Fi network to connect to it. If the network you selected is secured, you are required to enter a password or other credentials (you should contact the network operator for details). When finished, touch **CONNECT**.

## To add a Wi-Fi network

When Wi-Fi is on, you can add new Wi-Fi networks according to your preference.

- Touch **Settings** > **Network and Internet** > **Internet**.
- Touch **Add network**.
- Enter the name of the network and any required network information.
- Touch **CONNECT**.

## To forget a Wi-Fi network

The following steps prevent automatic connections to networks which you no longer wish to use.

- Turn on Wi-Fi, if it's not already on.
- On the Wi-Fi screen, touch the name of the saved network.
- Touch **FORGET** in the dialog that opens.

### 8.1.2 Aeroplane mode

Turn on **Aeroplane mode**  to simultaneously disable all wireless connections including Wi-Fi, Bluetooth and more.

### 8.1.3 Tethering

To share your tablet's data connection via USB and Bluetooth, go to **Settings > Network and Internet > Tethering** to activate these functions.

### 8.1.4 Data Saver

Touch **Settings > Network and Internet > Data Saver** and select **Use Data Saver** to help reduce data usage, some apps will not send and receive data when Data Saver is turned on. You can set unlimited apps through the menu **Unrestricted data**.

### 8.1.5 VPN

Virtual private networks (VPNs) allow you to connect to the resources inside a secured local network from outside that network. VPNs are commonly deployed by corporations, schools, and other institutions so that their users can access local network resources when not inside that network, or when connected to a wireless network.

#### To add a VPN

- Touch **Settings > Network and Internet > VPN** and then touch .
- On the screen that opens, follow your network administrator's instructions to configure each component of the VPN settings.

- Touch **SAVE**.

The VPN is added to the list on the VPN settings screen.



Before adding a VPN, you should set a screen lock for your tablet.

## To edit/delete a VPN

To edit a VPN:

- Touch **Settings** > **Network and Internet** > **VPN**.
- The VPNs you have added are listed. Touch the  icon next to the VPN you want to edit.
- After editing, touch **SAVE**.

To delete a VPN:

- Touch the  icon next to the selected VPN, then touch **FORGET** to delete it.

## 8.1.6 Private DNS

Touch to select private DNS mode.

## 8.2 Connected devices

Bluetooth is a short-range wireless communication technology that you can use to exchange data, or connect to other Bluetooth devices for various uses.

## To turn on Bluetooth

- Touch **Settings** > **Connected devices** > **Pair new device**.

Your device name and other available devices will appear on screen.

## To rename your device

- Touch **Settings** > **Connected devices** > **Pair new device**.
- Touch **Device name**.
- Enter a name, and touch **RENAME** to confirm.

## To pair/connect your tablet with a Bluetooth device

To exchange data with another device, you need to turn Bluetooth on and pair your tablet with the Bluetooth device with which you want to exchange data.

- Touch **Settings** > **Connected devices**.
- Touch + **Pair new device**.
- Touch a Bluetooth device you want to pair your tablet with in the list.
- In the dialog that pops up, touch **PAIR** to confirm.
- If the pairing is successful, your tablet will be connected to the device.

## To unpair from a Bluetooth device

- Touch  beside the device you want to unpair from.
- Touch **FORGET** to confirm.

## 8.2.1 Connection preferences

### Cast

This function can transmit your tablet content to TV or other device capable of supporting video over Wi-Fi connection.

- Touch **Settings > Connected devices > Connection preferences > Cast** .
- Touch the device name you want to connect.

**Note:** your device need to connet Wi-Fi network first before using this function.

### Printing

Touch **Printing** to activate Print services. You can select your **Default Print Service** or Touch  to choose Add printer.

### Nearby Share

Nearby Share is a service to send and receive files between Android devices located at proximity, A list of devices will appear in your proximity when using the Nearby Share feature, which you can share content with. When you tap on the reciever, they will be notified with the option to accept or decline the file you are sharing. Google's Nearby Share will then automatically choose the best protocol for fast and easy sharing using Bluetooth, Bluetooth Low Energy, WebRTC or peer-to-peer WiFi. This means you can use Nearby Share even when you are completely offline.

## 8.3 Apps

Touch to view details about the applications installed on your tablet, to manage their data usage or force them to stop.

## 8.4 Notifications

In the Notifications menu, you can configure whether to block the notifications from this app, hide sensitive content, etc.

## 8.5 Battery

Touch to view remaining battery percentage, you can turn on Battery percentage  to show battery percentage in status bar.

## 8.6 Storage

Use these settings to monitor the total and available space on your tablet and microSD card.

## 8.7 Sound

- Adjust the volume for Media, Alarm and Notification, or you can enable the silent mode.
- Set tones for notification and alarm
- Turn on/off Screen locking, Charging or Touch sound.

- Do not disturb: you can turn this mode on as scheduled, then notifications will be silenced (except for alarms), and the tablet will not wake up when the screen is off.

## 8.8 Display

In this menu, you can adjust your screen brightness, select screen display mode such as dark theme, eye comfort mode, set screen timeout, font size, etc.

To rotate screen contents when device is rotated, touch **Auto-rotate screen**.

## 8.9 Wallpaper

You can choose the default pictures or use photos as wallpaper.

## 8.10 Accessibility

Use the Accessibility settings to configure any accessibility plug-ins you have installed on your tablet.

## 8.11 Security

### Security status

- Google play protect: Play Protect regularly checks your apps and devices for harmful behaviour. You will be notified of any security risks found.

- Security update: You can check is there system update?
- Find My Device: turn on  to help you locate your device remotely, if you lose your device, it also can help you keep your data safe.

## Device Security

- Screen lock: Choose screen lock such as None, Swipe, Pattern (draw an unlock pattern), Pin (set a PIN), Password (set a password).

## More security settings

You can also set Device admin apps, Encryption & credentials, Screen pinning and Trust Agents in **Settings > Security** .

- Smart Lock: Smart Lock keeps your device unlocked when it's safe with you and locked when it detects that it's been put down.
- Enabling Device admin apps allows **Find My Device** to lock or erase a lost device.
- Encryption & credentials: you can see the encryption and credential information of your tablet.

- Trust agents is a service that tells the system whether your tablet environment is trusted. When a trust agent thinks it can trust the current environment, it will notify the system through a callback, and the system will decide how to bypass your tablet's security configuration. A typical example is: when in a trusted environment, the system grants the you the ability to bypass the lock screen.
- App Pinning allows you to keep the current app in view until you unpin it.

## 8.12 Privacy

To protect your privacy, you can set an app to be allowed or forbidden to access your location, contacts, etc. Also whether or not to show passwords or choose the activities and info that you want to Google to save.

## 8.13 Location

Touch to set whether to allow an app to access your device's location. You can set allowing continual access, or only while the app is in use.

## 8.14 Safety & emergency

Emergency Location Service: turn this feature on, your device can automatically send its location to emergency response partner when you call or text an emergency number.

Earthquake alerts: turn it on, when an earthquake is detected nearby, you will get an alert with the initial estimated magnitude and distance from your location.

## 8.15 Password and accounts

In this menu you can choose password or auto-fill for google service. Or touch **Add account** to add an account for owner.

## 8.16 Digital Wellbeing and parental controls

In this menu you can find how much time you have spent on the tablet and even on each app. You can customise the time limit for using the tablet so that have a healthy and balanced life. In addition, parents are able to restrict their children's usage time to manage their browsing habits.

## 8.17 Google

Touch to configure your Google account and services settings.

## 8.18 DuraSpeed

DuraSpeed helps boost the foreground app by restricting background apps, you can turn on the switch of background apps in the list to make it unrestricted.

## 8.19 System

### 8.19.1 Languages and input

Touch to configure language settings, the Physical keyboard, Spell checker, pointer speed, etc.

### 8.19.2 Gestures

In this menu, you can set gestures for quick and convenient operations.

### 8.19.3 Date & time

Use Date & time settings to customise your preferences for how date and time are displayed.

## 8.19.4 Backup

Turn on  to back up your tablet's settings and other application data to Google servers. If you replace your tablet, the settings and data you've backed up will be restored onto the new device when you sign in with your Google account.

## 8.19.5 Multiple users

You can share this device with other people by creating additional users. Each user has their own space, which they can customise with apps, wall paper and so on.

### Reset options

Touch to reset Wi-Fi, Bluetooth, Reset app preferences, or Erase all data.

## 8.19.6 Regulatory & safety

Touch to view product information.

## 8.20 About tablet

This contains information such as device specification, CPU, Legal information, Model type, Build number, etc.

# 9 Making the most of your tablet .....

## 9.1 FOTA Upgrade

Use the FOTA (Firmware Over The Air) Upgrade tool to update your tablet's software. To access **Updates**, from the app list, touch **Settings > System > System Update**.

If you want to update the system, touch **Check for update** and when that's finished, your tablet will have the latest version of the software.

During FOTA downloading or updating, to avoid errors in locating the correct update packages, do not change your default storage location.

# 10 Accessories.....

## Standard accessories

1. Charger
2. USB Cable
3. Quick Start Guide and safety information leaflet



- Accessories depend on countries.

# 11 Troubleshooting.....

Before contacting the service center, here are some instructions to help you troubleshoot your device:

- For optimal operation, fully charge the battery.
- To improve the tablet's performance, remove unnecessary files or apps on your tablet.
- Update your tablet's software, go to **Settings > System > System Update**.
- Reset your tablet via **Erase all data (factory reset)**. Touch **Settings > System > Reset** options. Another method is to hold down the **Power** key and the **Volume up** key at the same time when your tablet is powered off, and then select **Wipe data/factory reset** by pressing volume down key. All your tablet data will be lost permanently. It is strongly advised to fully back up your tablet data before resetting.

and carry out the following checks:

## **My tablet can't be switched on or is frozen**

- When the tablet can't be switched on, charge for at least 20 minutes to ensure the minimum battery power needed. Then switch it on again.

- When the tablet falls into a loop during power on animation and the user interface can't be accessed, press and hold the **Power** key to reset. This eliminates any abnormal OS booting issues caused by third party applications.
- If neither method is effective, reset the tablet by pressing the Power key and the Volume up key at the same time, selecting a language, and then selecting **Wipe data/Factory reset**. Press the **Volume** key to select, and press the **Power** key to confirm each selection.

### **My tablet has not responded for several minutes**

- If your tablet doesn't respond, turn off your tablet by pressing and holding the **Power** key until it turns off and then restart it again.
- If your tablet has a removable battery, remove the battery and reinsert it, then restart the tablet.
- If it still doesn't work, reset the tablet.

### **My tablet turns off by itself**

- Check that your screen is locked when you are not using your tablet, and make sure that the **Power** key is not accidentally pressed while the screen is unlocked.
- Check the battery charge level.
- If it still doesn't work, reset the tablet or update software.

## **My tablet can't charge properly**

- Make sure that you are using the **TCL** charger that comes with the tablet.
- If your tablet has a removable battery, make sure that your battery is inserted properly and clean the battery contact if it's dirty. It must be inserted before plugging in the charger.
- Make sure that your battery is not completely discharged; if the battery power has been empty for a long time, it may take around 20 minutes to display the battery charging indicator on the screen.
- Make sure that charging is carried out under normal conditions (0°C (32°F) to 40°C (104°F)).
- When abroad, check that the voltage input is compatible.

## **My tablet can't connect to a network or "No service" is displayed**

- Try connecting to the network by moving to another physical location.
- Verify the network coverage with your operator.
- Try connecting at a later time if the network is overloaded.

## **My tablet can't connect to the internet**

- Check your tablet's internet connection settings.

- Make sure that you are in a place with network coverage.
- Try connecting at a later time or another location.

### **I can't use the features described in the manual**

- Check with your operator to make sure that your subscription includes this service.
- Make sure that this feature doesn't require an **TCL** accessory.

### **I can't connect my tablet to my computer**

- Check to make sure the USB port is not broken. If it's not working, try another USB port on your computer.
- Make sure USB drivers are properly installed.
- If you are using a Windows computer, make sure it supports MTP mode. If you are using a Mac, make sure to install Android File Transfer from [www.android.com/filetransfer/](http://www.android.com/filetransfer/).

### **I can't download new files**

- Make sure that there is sufficient tablet storage space for your download.
- Select the microSD card as the location to store downloaded files.
- Check your subscription status with your operator.

### **The tablet can't be detected by others via Bluetooth**

- Make sure that Bluetooth is turned on and your tablet is visible to other users.

- Make sure that the two tablets are within Bluetooth's detection range.

### **The battery drains too fast**

- Make sure that you follow the complete charge time (minimum 270 minutes).
- After a partial charge, the battery level indicator may not be exact. Wait for at least 20 minutes after removing the charger to obtain an exact indication.
- Adjust the brightness of screen as appropriate.
- Extend the email auto-check interval for as long as possible.
- Update news and weather information on manual demand, or increase their auto-check interval.
- Exit background-running applications if they are not being used for extended periods of time.
- Turn off Bluetooth or Wi-Fi when not in use.

### **The tablet becomes warm following game playing, internet surfing or running other complex applications**

- This heating is a normal consequence of the CPU handling excessive data. Ending the above actions will make your tablet return to normal temperature.

## **After a factory data reset is performed, I can't use my tablet without entering Google account credentials**

- After a reset is performed, you must enter the original Google account credentials that were used on this tablet.
- If you don't remember your Google account credentials, complete Google account recovery procedures.
- If you still cannot access your tablet, apply to the authorised repair centre, but remember that it will not be regarded as warranty case.

## **I forget some passwords/codes/keys on tablet**

- Perform a factory data reset.
- If you still cannot access your tablet, apply to the authorised repair centre, but remember that it will not be regarded as a warranty case.

# 12 Specifications.....

**Processor :**

MT8766B

**Platform :**

Android 13

**Memory :**

32GB ROM + 3GB RAM

**Dimensions (LxWxT) :**

241.2\*156.6\*7.99mm

**Weight :**

470g

**Display :**

800\*1280

**Connectivity :**

- Bluetooth BT5.0
- Wi-Fi 802.11a/b/g/n/ac
- USB Type C

**Camera :**

- 2M front camera
- 2M rear camera

## **Audio supported formats :**

AAC LC, HE-AACv1 (AAC+), HE-AACv2 (enhanced AAC+), AAC ELD (enhanced low delay AAC), AMR-NB, AMR-WB, FLAC, MP3, MIDI, Vorbis, PCM/WAVE

## **Battery <sup>(1)</sup> :**

Capacity: 6000mAh

## **Expansion Slot :**

microSD™ memory card  
(Availability of microSD card depends on market)

**Note:** Specifications are subject to change without prior notice.

<sup>(1)</sup> The original battery has undergone rigorous safety inspections to meet qualification standards, the use of non-original batteries may be dangerous.

## **Disclaimer**

There may be certain differences between the user manual description and the tablet's operation, depending on the software release of your tablet or specific carrier services.

TCL Communication Ltd. shall not be held legally responsible for such differences, if any, nor for their potential consequences, which responsibility shall be borne by the carrier exclusively.