

➤ Instructions

Thule Epos 2-bike
903210

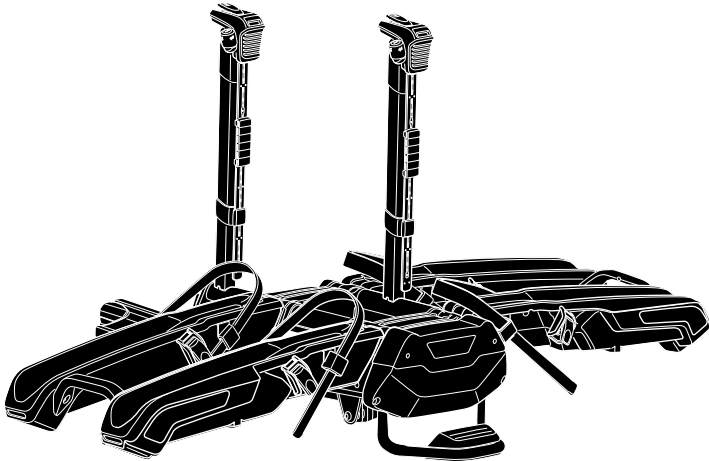

THULE.COM

**EN**

HITCH BIKE RACKS

FAILURE TO COMPLY WITH THE MANUFACTURER'S INSTRUCTIONS CAN LEAD TO SERIOUS INJURY OR DEATH.

IMPORTANT - READ CAREFULLY AND KEEP FOR FUTURE REFERENCE.

 **WARNING** INDICATES A HAZARDOUS SITUATION WHICH, IF NOT AVOIDED, COULD RESULT IN DEATH OR SERIOUS INJURY.

 **NOTE** INDICATES ADDITIONAL INFORMATION THAT IS USEFUL FOR TROUBLE-FREE AND OPTIMAL USE OF THE PRODUCT.

FR

PORTE-VÉLOS SUR ATTELAGE

LE NON-RESPECT DES INSTRUCTIONS DU FABRICANT PEUT ENTRAÎNER DES BLESSURES GRAVES OU LA MORT.

IMPORTANT - LISEZ ATTENTIVEMENT CES INSTRUCTIONS ET CONSERVEZ-LES POUR RÉFÉRENCE FUTURE..

 **AVERTISSEMENT** INDIQUE UNE SITUATION POTENTIELLEMENT DANGEREUSE QUI, SI ELLE N'EST PAS ÉVITÉE, POURRAIT PROVOQUER DES BLESSURES GRAVES, VOIR MORTELLES.

 **REMARQUE** INDIQUE COMMENT RÉPONDRE À UNE SITUATION DONNÉE U VOUS DONNENT DES CONSEILS SUR LE FONCTIONNEMENT DES OPTIONS DISPONIBLES.

ES

PORTABICICLETAS PARA ENGANCHE

EL INCUMPLIMIENTO DE LAS INSTRUCCIONES DEL FABRICANTE PUEDE PROVOCAR LESIONES GRAVES O LA MUERTE.

IMPORTANTE - LEA ATENTAMENTE Y CONSÉRVELO PARA FUTURAS CONSULTAS.

 **ADVERTENCIA** INDICA UNA SITUACIÓN DE PELIGRO QUE, SI NO SE EVITA, PODRÍA PROVOCAR LESIONES GRAVES O INCLUSO LA MUERTE.

 **NOTA** INDICA INFORMACIÓN ADICIONAL QUE ES ÚTIL PARA UN USO ÓPTIMO Y SIN PROBLEMAS DEL PRODUCTO.

PT

SUPORTE PARA BICICLETA DE ENGATE AMERICANO

O NÃO CUMPRIMENTO DAS INSTRUÇÕES DO FABRICANTE PODE LEVAR A FERIMENTOS GRAVES OU À MORTE.

IMPORTANTE - LEIA COM ATENÇÃO E GARDE PARA REFERÊNCIA FUTURA

 **ATENÇÃO** INDICA UMA SITUAÇÃO PERIGOSA QUE, SE NÃO FOR EVITADA, PODE RESULTAR EM MORTE OU FERIMENTOS GRAVES.

 **NOTA** INDICA INFORMAÇÕES ADICIONAIS QUE SÃO ÚTEIS PARA O USO IDEAL E SEM PROBLEMAS DO PRODUTO.

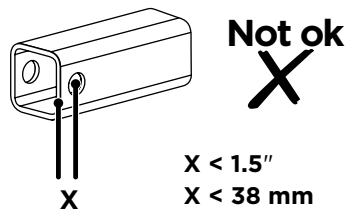
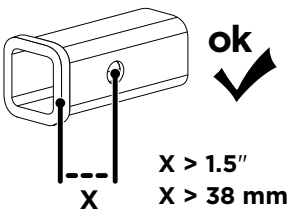
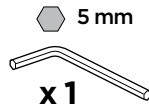
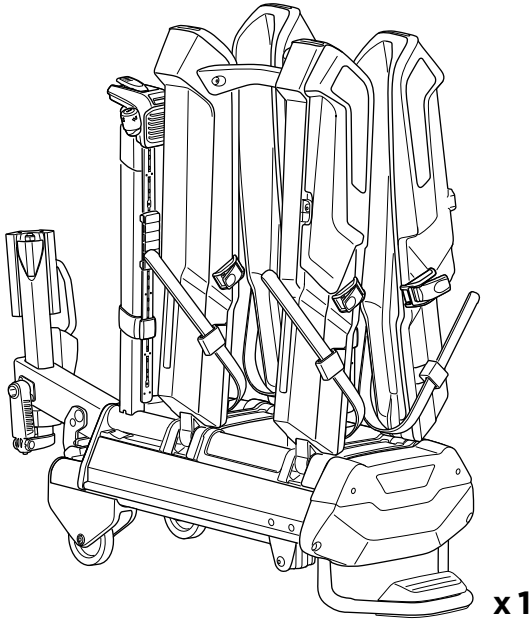

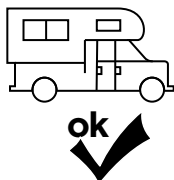
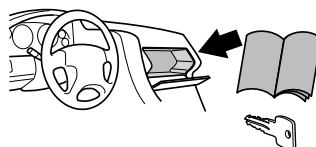
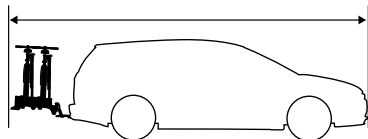
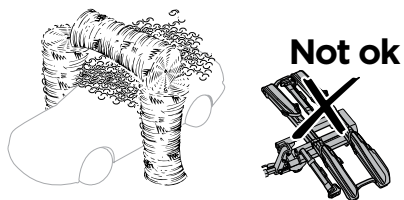
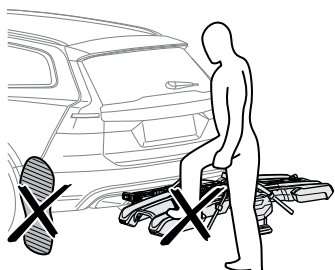
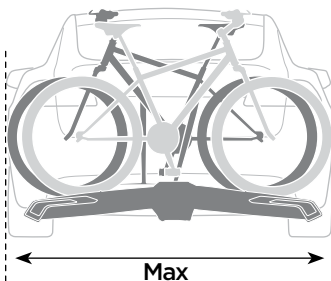
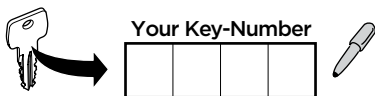
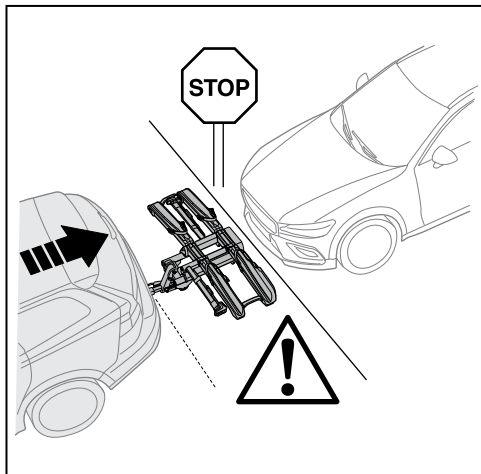

Load capacity
Capacité
Capacidad de carga
Capacidade de carga



Max 75 lbs. (34 kg)



Max 140 lbs. (64 kg)



38.1 lbs. (17.3 kg)



ok



ok



Not ok



Not ok



16" min and 29" max

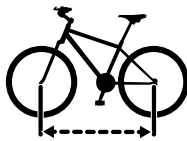

Max 53" wheelbase



3" max

Thule XXL Fatbike Wheel Straps 9851

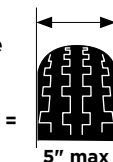

5" max

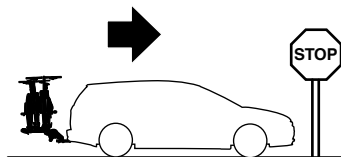

300 miles
500 km

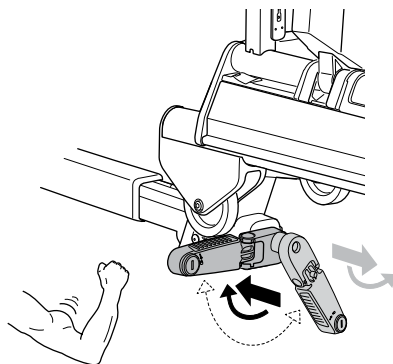

7.5 lb ft
10 Nm

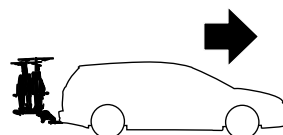

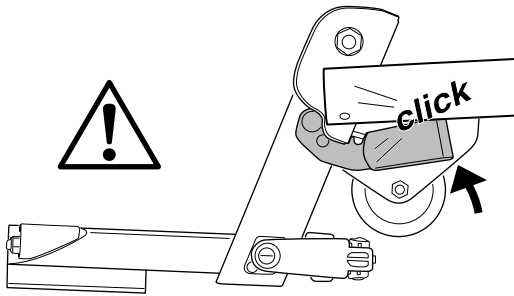
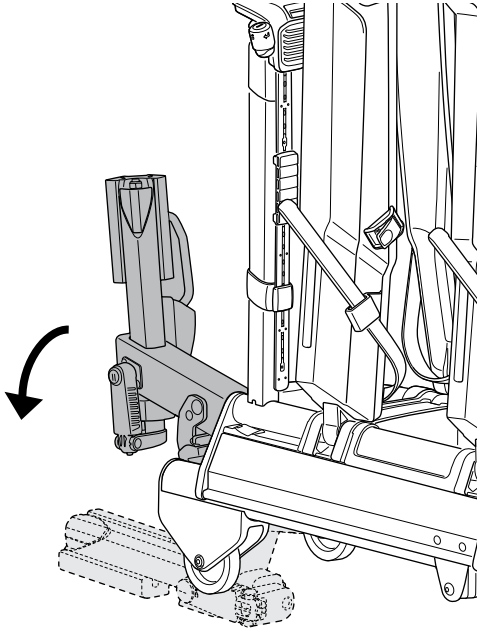

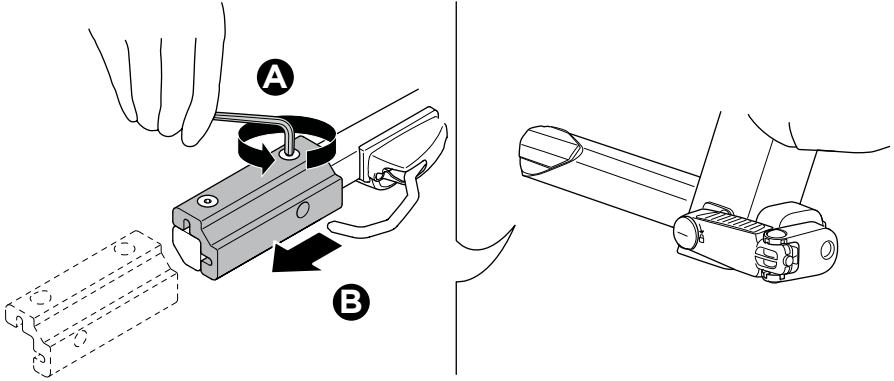
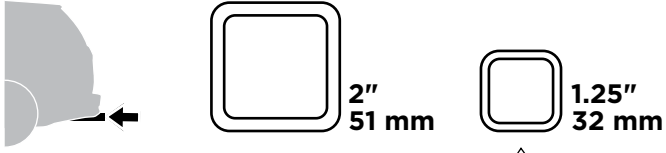

2

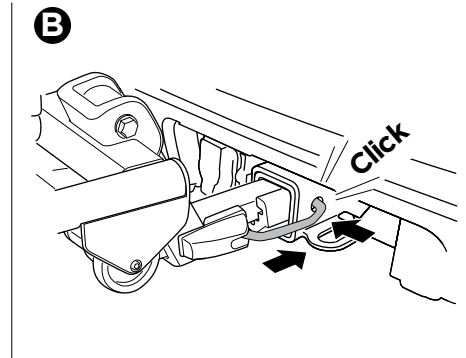
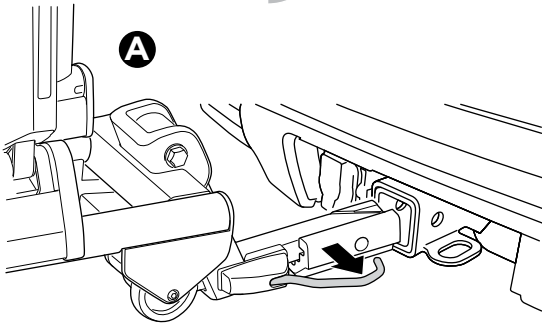
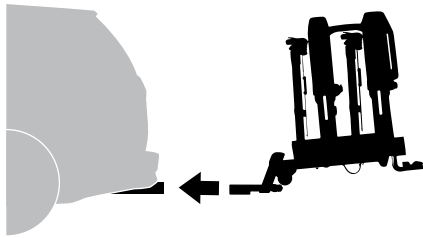

3

A

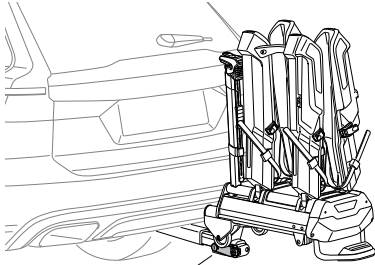

B

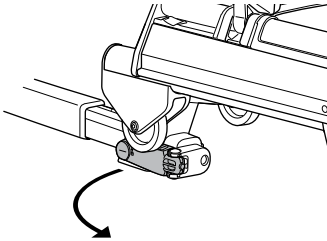

C

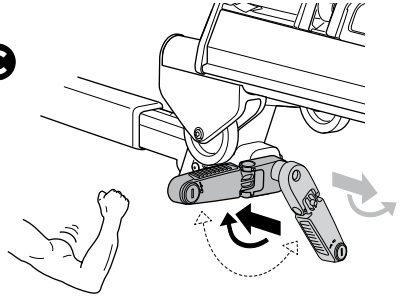

7.5 lb ft
10 Nm

D

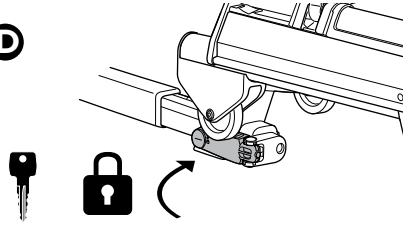

4

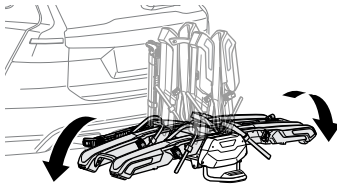

Not ok



3

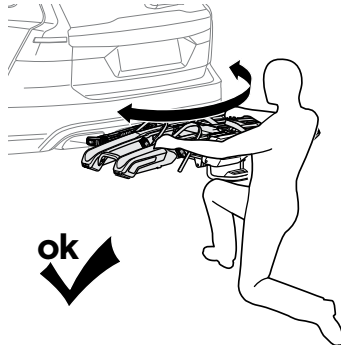

ok

5

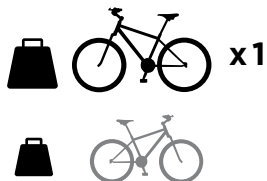
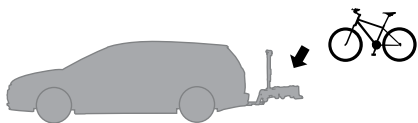
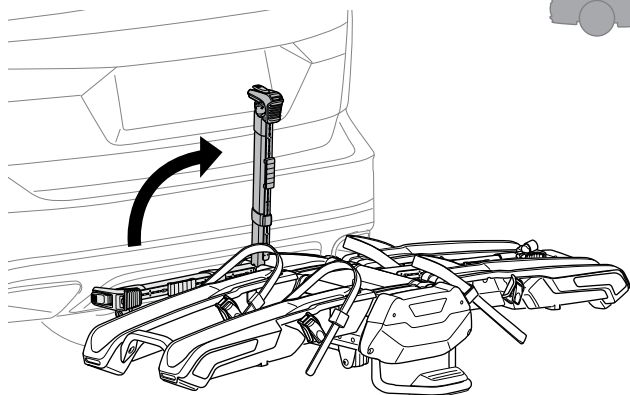

0.8-3.5"
20-90mm

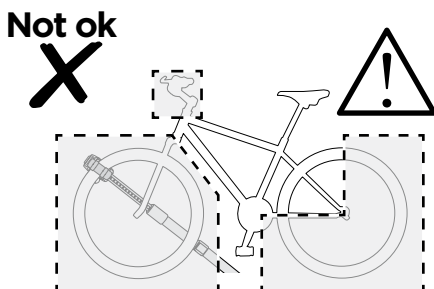
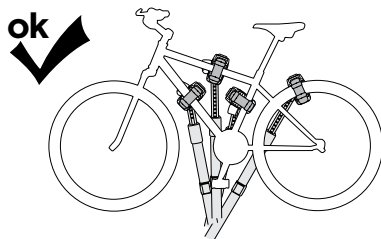
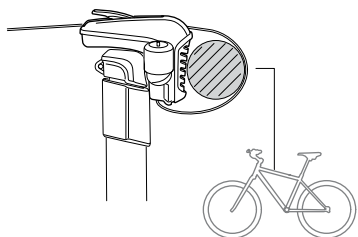

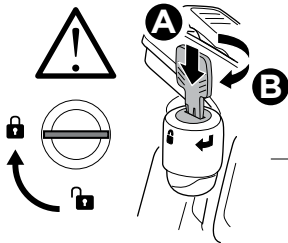
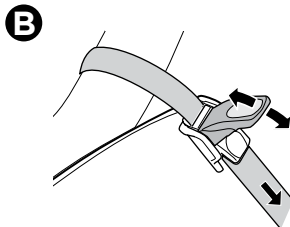
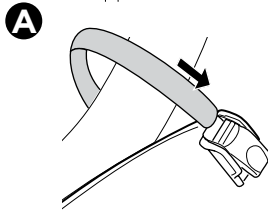
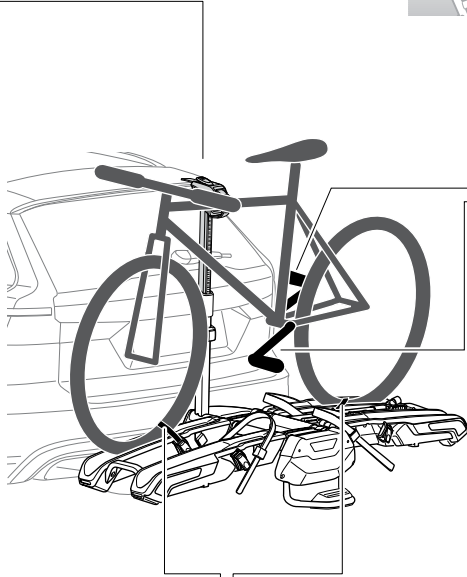
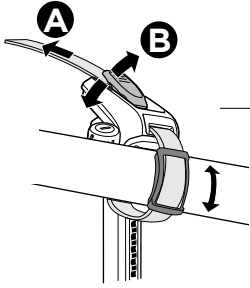
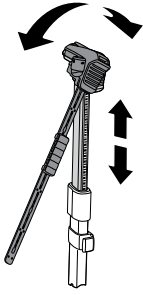
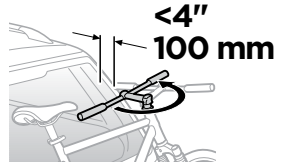

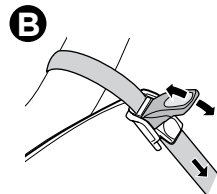
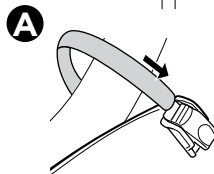
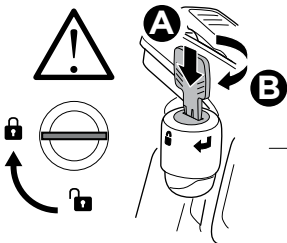
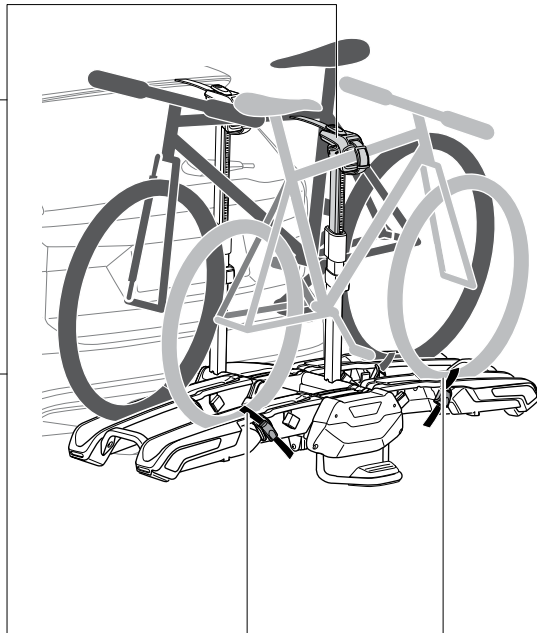
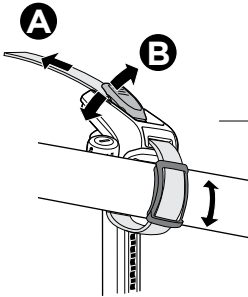
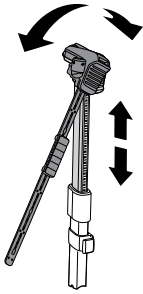
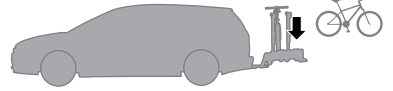
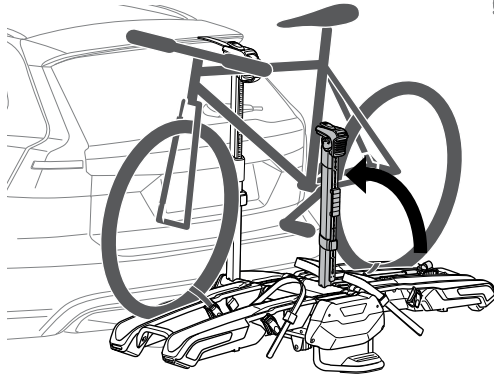

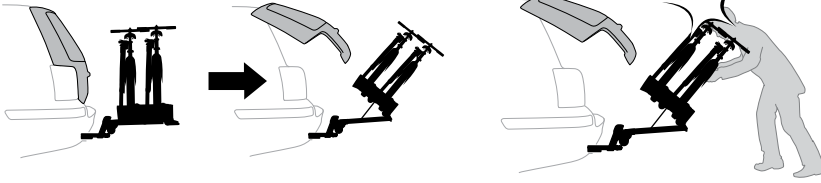

7

ok
✓

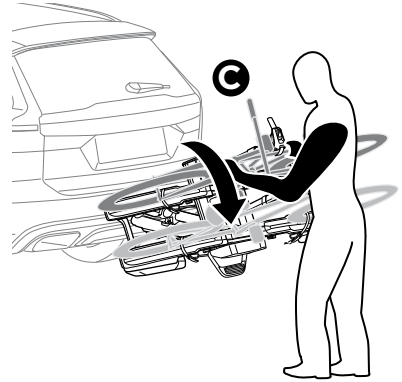
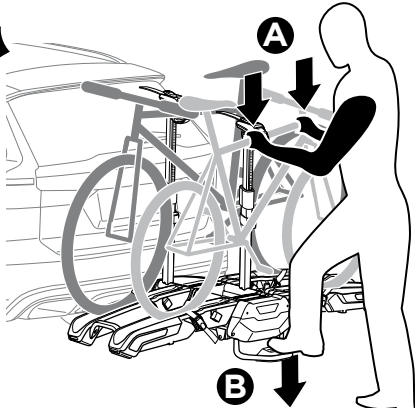

Not ok
✗

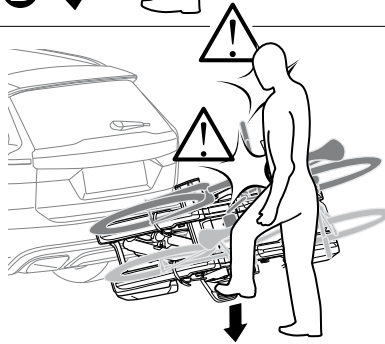

8

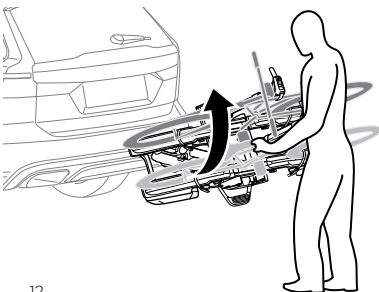

Click

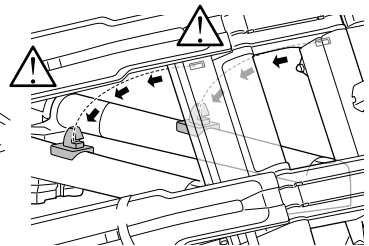

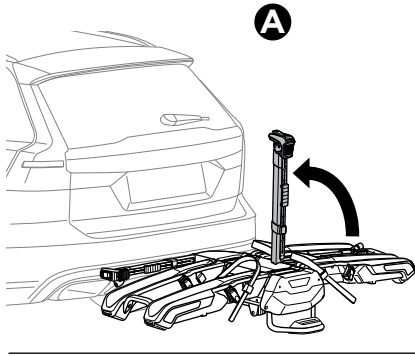

ok ✓

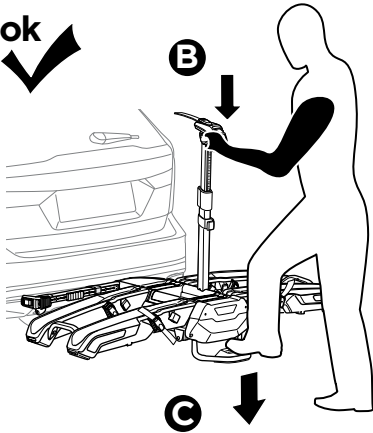

Not ok ✗

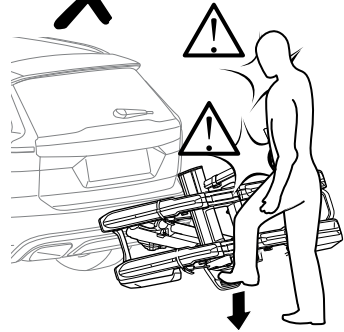

ok ✓

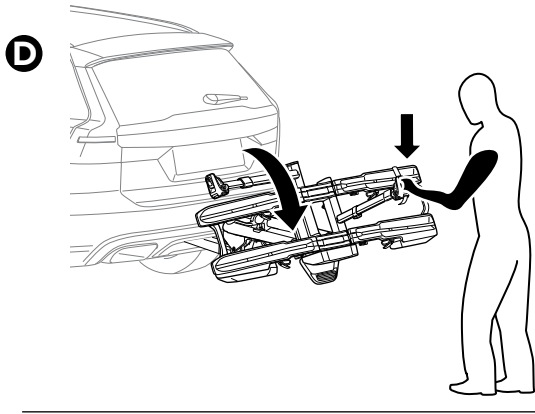



Not ok



ok

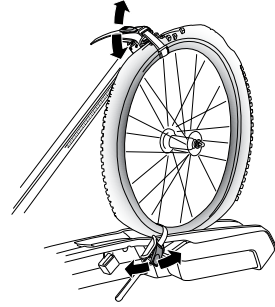

i

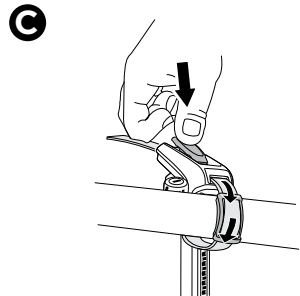
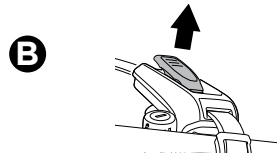
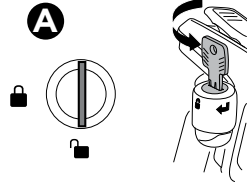
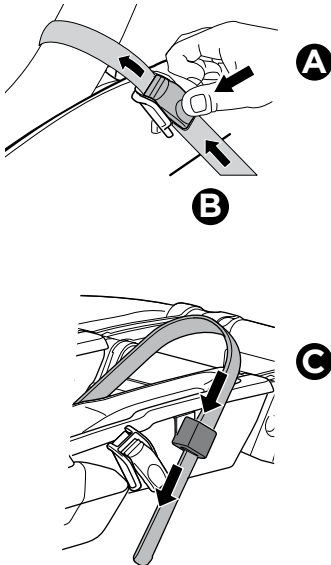
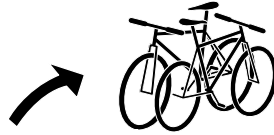
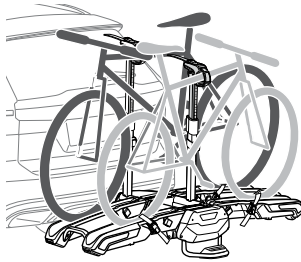

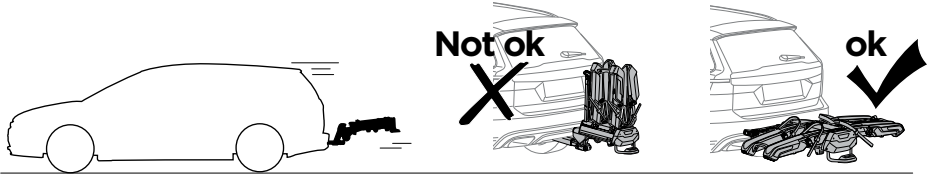

A

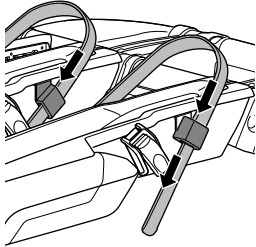

B

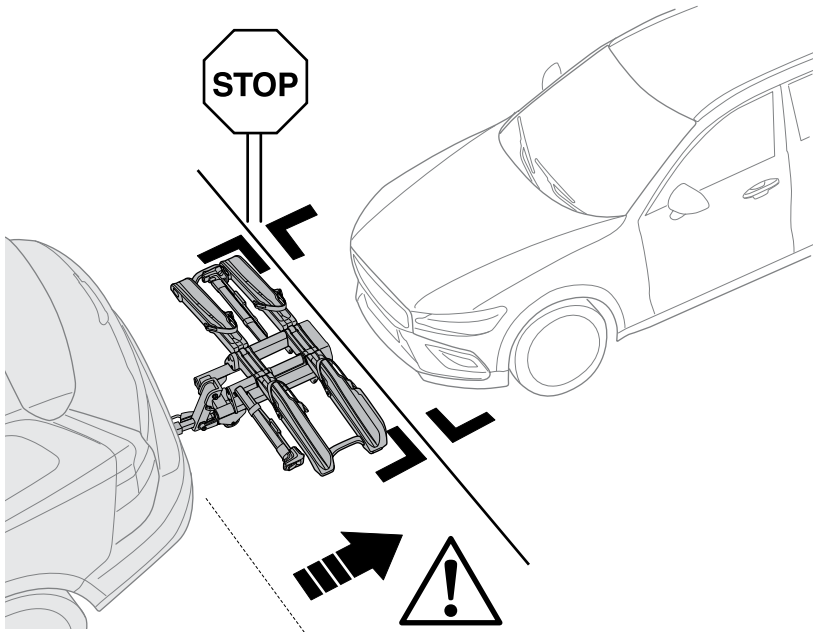
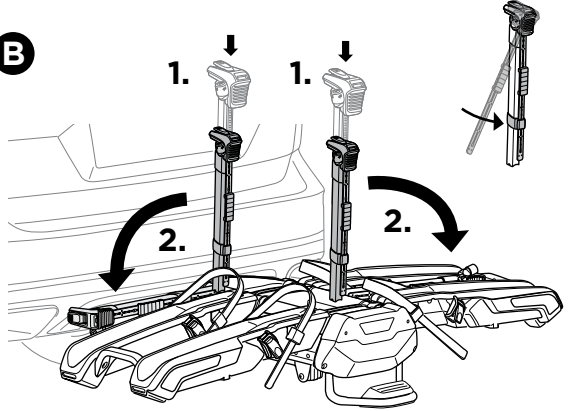

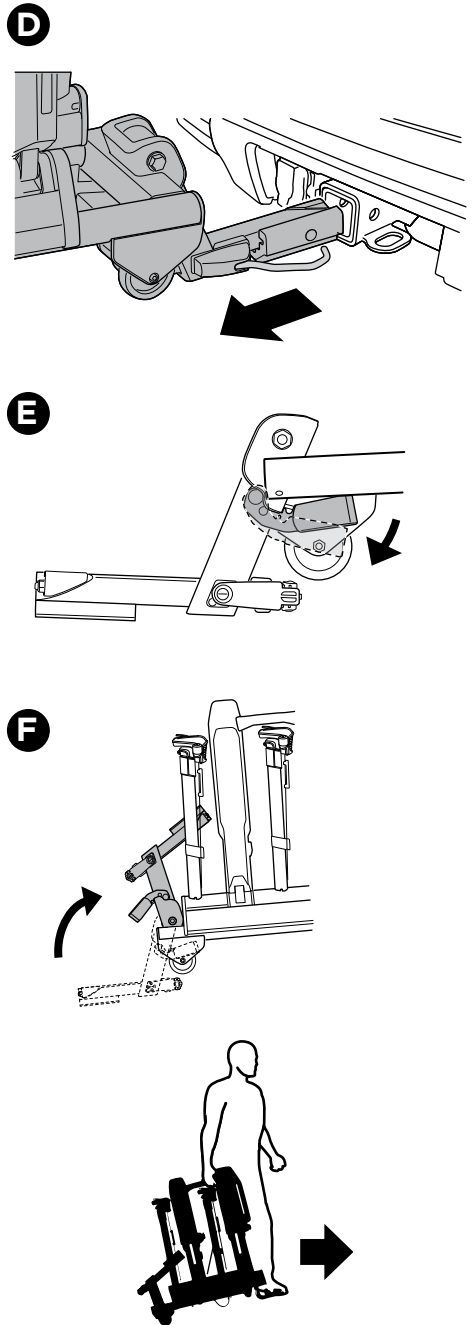
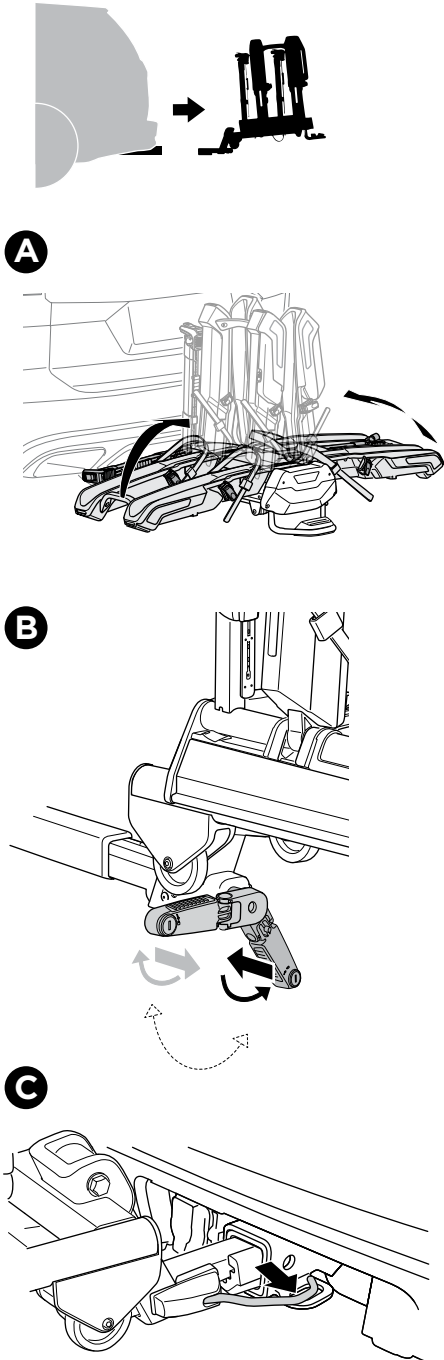

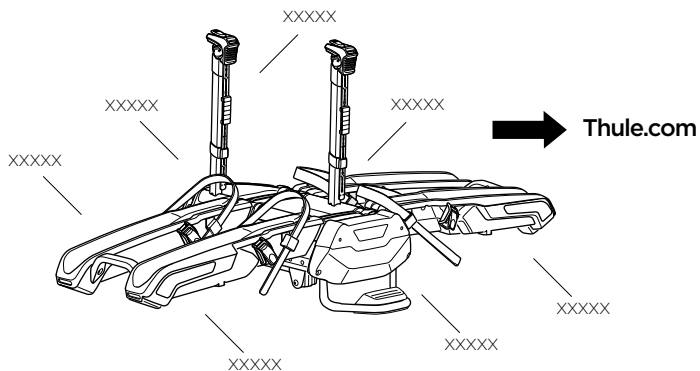

EN Accessoires
FR Accessoires

ES Accesorios
PT Acessórios

Thule Epos Light & Plate Kit
90332

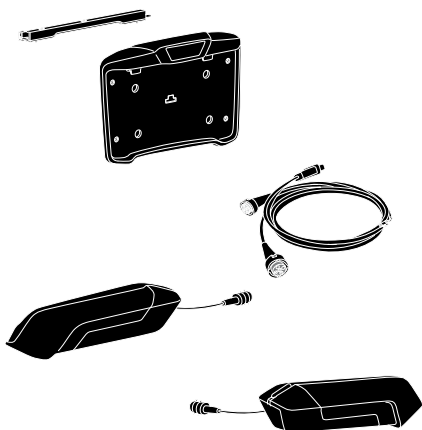

Thule High-Grade Lock
9785

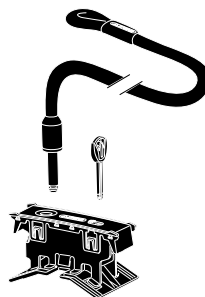

Thule XXL Fatbike Wheel Straps
9851

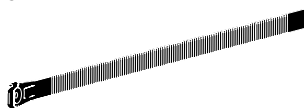

Thule Foldable Loading Ramp
9334

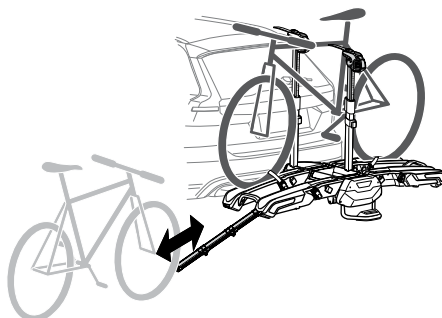
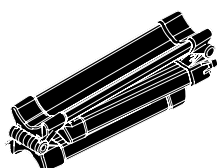

Thule One-Key System

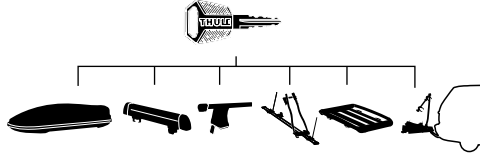

450200  (x2)

450400  (x4)

450600  (x6)

450800  (x8)

Thule Epos 2-bike Storage Bag 9786

A

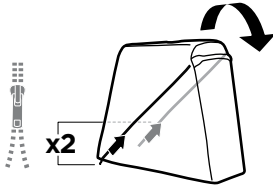

C

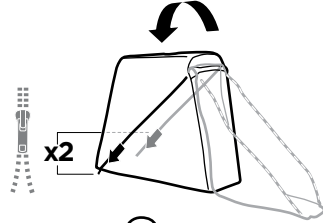

B

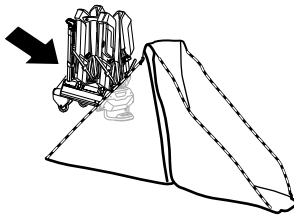

D



i

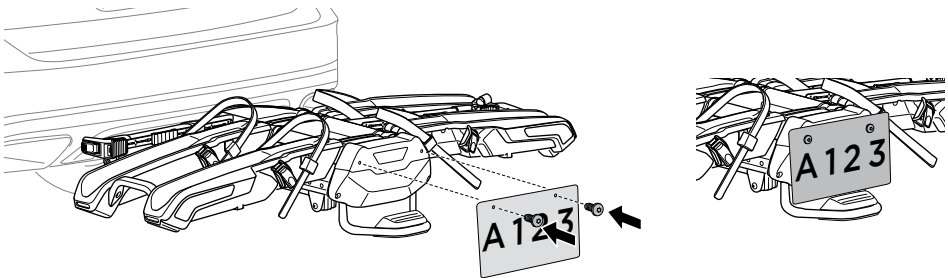

THULE[®]
SWEDEN

Register online at
www.thule.com/register

Thule Inc. • 42 Silvermine Road • Seymour, CT 06483
Thule Canada Inc. • 710 Bernard • Granby QC J2J 0H6
North American Consumer Service: Toll Free 800-238-2388 / Fax 450-777-3615 • www.thule.com