

1

Kit 145366

TOYOTA Crown Crossover, 4-dr Sedan, 23-

ISO 11154-E

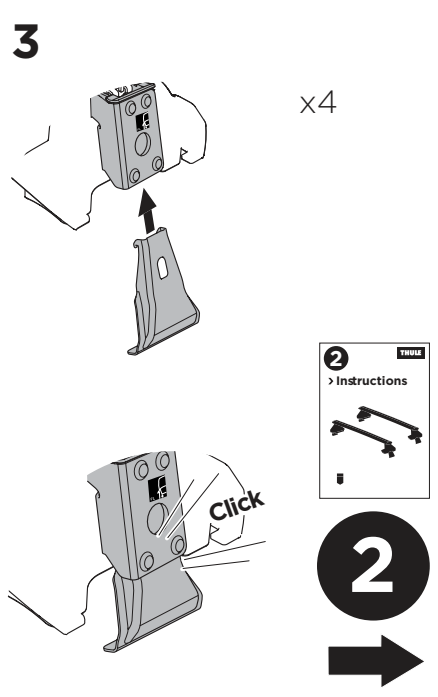
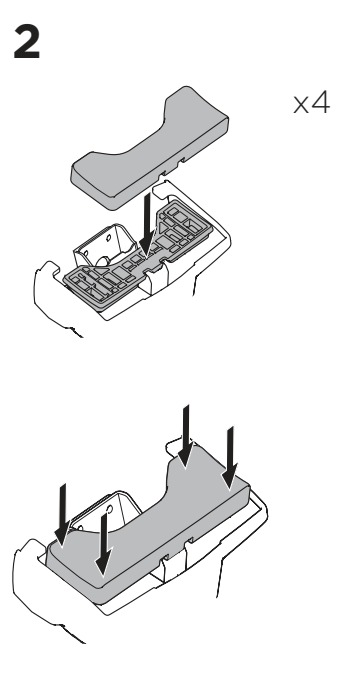
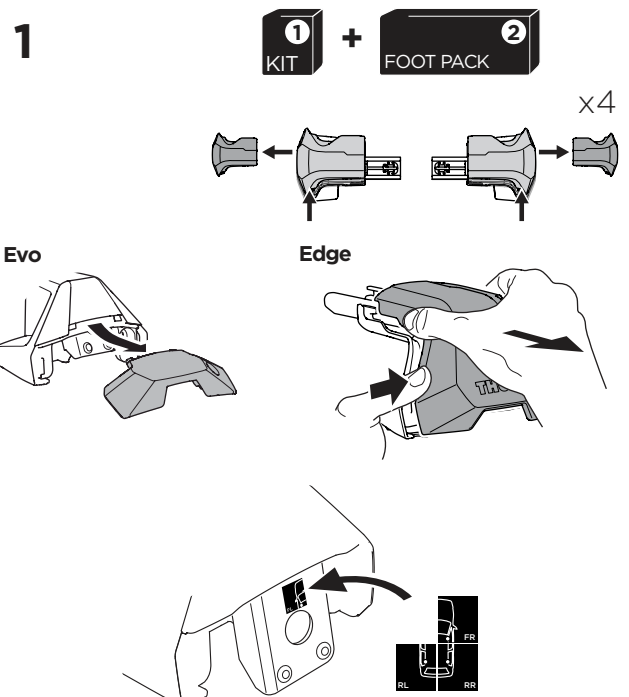
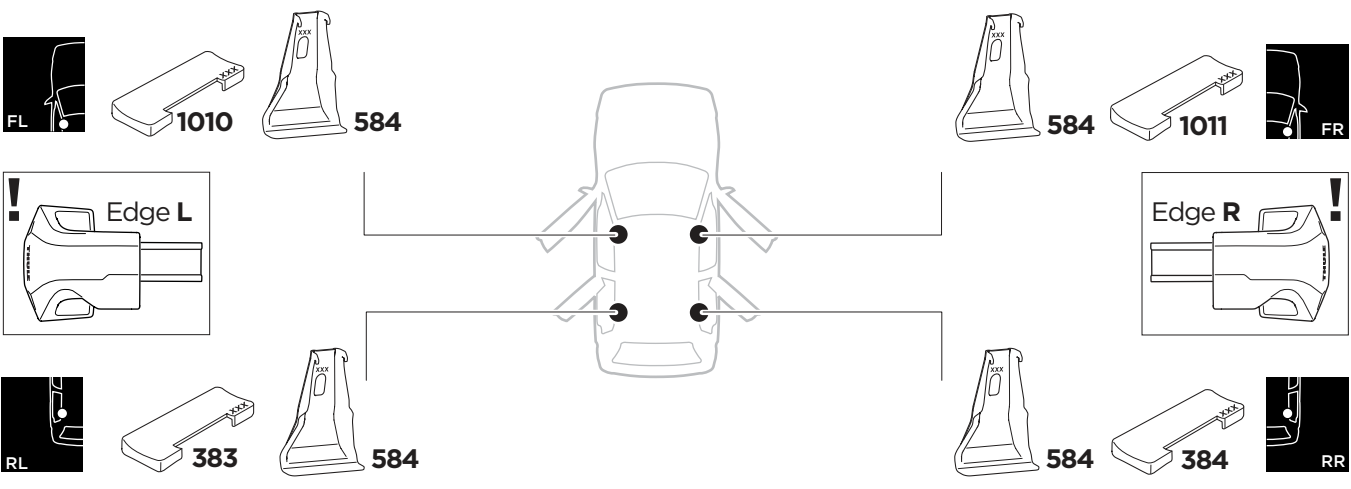
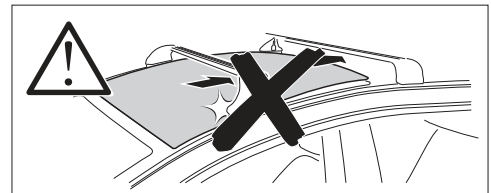
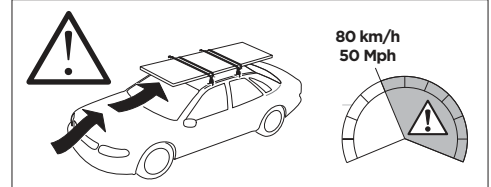
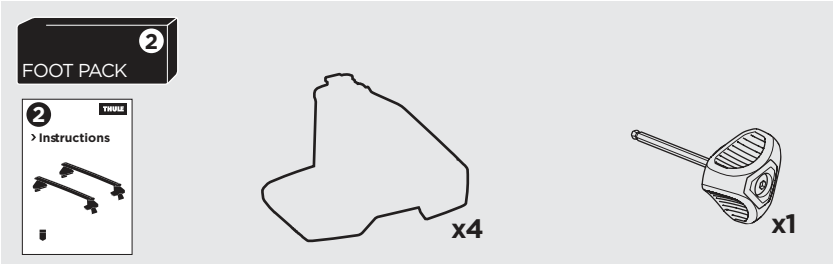
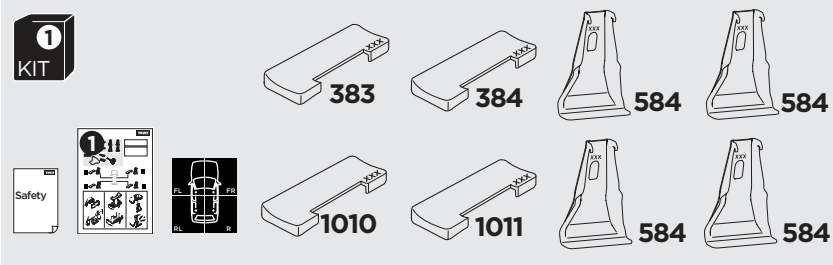

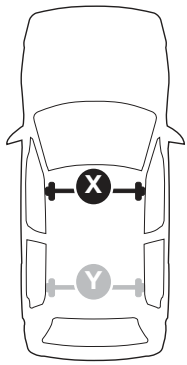

| | | | | | |
|--|--------------------|---------------|---------------------|----------------------|-----------------------|
| THULE WingBar Evo | THULE WingBar Edge | THULE WingBar | THULE SquareBar Evo | Evo X (scale) | Edge X (scale) |
| TOYOTA Crown Crossover, 4-dr Sedan, 23- | | | | 39 | A |
| THULE ProBar Evo | THULE SlideBar Evo | | | | X (mm/inch) |
| TOYOTA Crown Crossover, 4-dr Sedan, 23- | | | | 1041 mm / 41" | |

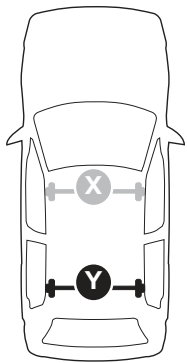

| | | | | | |
|--|--------------------|---------------|---------------------|--------------------------|-----------------------|
| THULE WingBar Evo | THULE WingBar Edge | THULE WingBar | THULE SquareBar Evo | Evo Y (scale) | Edge Y (scale) |
| TOYOTA Crown Crossover, 4-dr Sedan, 23- | | | | 37 | E |
| THULE ProBar Evo | THULE SlideBar Evo | | | | Y (mm/inch) |
| TOYOTA Crown Crossover, 4-dr Sedan, 23- | | | | 1021 mm / 40 1/4" | |

| | W (mm/inch) | Z (mm/inch) |
|--|-------------------------|--------------------|
| TOYOTA Crown Crossover, 4-dr Sedan, 23- | 700 mm / 27 1/2" | 230 mm / 9" |

