

**TOWER**<sup>®</sup>  
over 100 YEARS of quality

**XpressPro**  
COMBO



MODEL: T17076

**11 LITRE**  
**10-IN-1 DIGITAL AIR FRYER OVEN**  
*with rotisserie*



**USER MANUAL**



GREAT BRITISH DESIGN, INNOVATION AND EXCELLENCE **SINCE 1912**

# Table of contents

---

<b>THIS BOX CONTAINS</b>	1
<b>SPECIFICATIONS</b>	1
<b>IMPORTANT SAFETY INFORMATION</b>	2
• Key safety points	2
• General safety	2
• Whilst air frying	3
• Plug and cord	3
• Wiring safety	3
<b>GETTING TO KNOW YOUR AIR FRYER OVEN</b>	5
• Control panel and display	6
<b>BEFORE FIRST USE</b>	7
• Setting up	7
• Trial run	7
<b>USING YOUR AIR FRYER OVEN</b>	8
• Using the accessories	8
• Cooking with the air fryer oven	11
• Settings and pre-set programs	12
• Pre-heating	16
• Getting the best results from your air fryer oven	16
• Weights and measures	17
• Additional functions	17
<b>ACCESSORIES / SPARE PARTS</b>	18
<b>CLEANING AND CARE</b>	19
<b>TROUBLESHOOTING</b>	20
<b>DISPOSAL OF THE UNIT</b>	21
<b>CUSTOMER SUPPORT</b>	21

# This box contains

*Instruction manual*

*Recipe book*

*Air fryer oven*

*Air flow racks x 3*

*Rotisserie fork and handle*

*Oil drip tray*

*Reversible grill plate*

*Wire rack*

*10 skewers plus  
rotating wheels*

*Heat-proof silicone  
finger mitts*

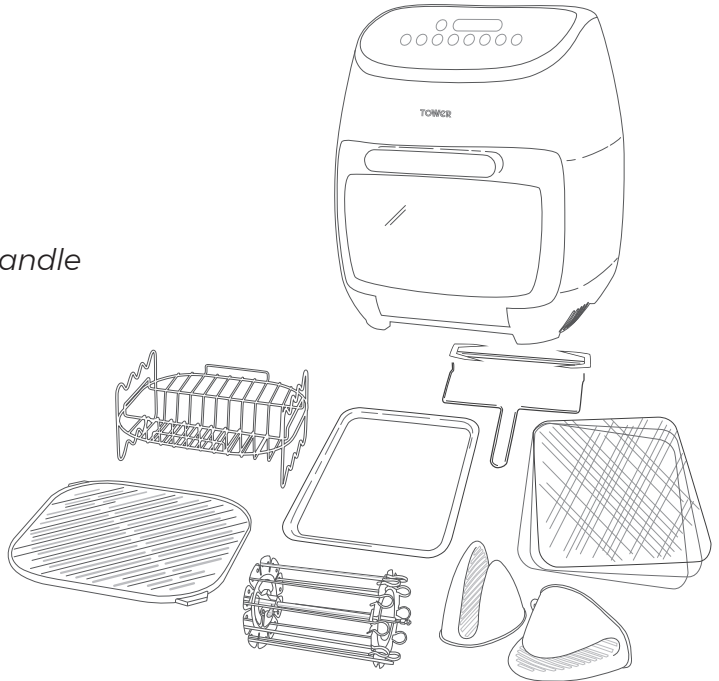

# Specifications

<b>RATED VOLTAGE</b>	AC 220 - 240V
<b>FREQUENCY</b>	50/60Hz
<b>POWER CONSUMPTION</b>	2000W
<b>CAPACITY</b>	11L
<b>TEMPERATURE RANGE</b>	30°C - 200°C
<b>TIME RANGE</b>	1-60 minutes
<b>DIMENSIONS (CM)</b>	H38.2 x W32.4 x D33.9
<b>WEIGHT</b>	5Kg

# Important safety information

## Please read these safety NOTES carefully BEFORE using your Tower appliance

These warnings have been provided in the interest of safety. Basic safety precautions should always be followed including the following:

### KEY SAFETY POINTS

**CAUTION:** During operation:

- Surfaces are hot. **DO NOT** touch the hot surfaces.
- Hot steam is released through the air outlet openings. Keep your hands and face at a safe distance from the steam and from the air outlet openings.
- Hot steam and air may escape when the appliance door is opened.

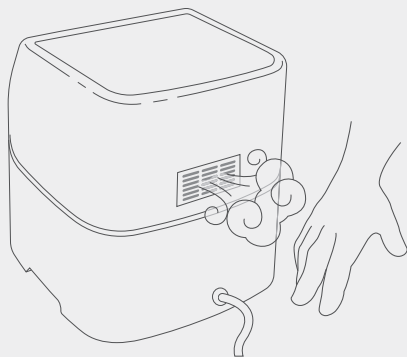

*It is important that this instruction manual is retained for future reference. If the appliance is given to someone else, it should always be accompanied by these operating instructions, as they form an integral part of the appliance.*

## GENERAL SAFETY

- **DO NOT** immerse cords, plugs or any part of the appliance in water or any other liquid.
- Close supervision is necessary when any appliance is used by or near children.
- Children should not play with the appliance.
- This appliance is not to be used by children or persons with reduced physical, sensory or mental capabilities or lack of experience and knowledge, unless they have been given supervision or instruction concerning use of the appliance in a safe way and understand the hazards involved.
- Cleaning and user maintenance should not be undertaken by children without supervision.
- Take care when any appliance is used near pets.
- Switch off and unplug before fitting or removing accessories, after use and before cleaning.
- Allow the appliance to cool down for approximately 30 minutes before fitting or removing accessories or cleaning.
- If the supply cord or appliance is damaged, stop using the appliance immediately and seek advice from the manufacturer, its service agent or a similarly qualified person.
- The use of accessory attachments is not recommended by the appliance manufacturer, apart from those supplied with this product.
- **DO NOT** use the appliance outdoors.
- **DO NOT** place the appliance on or near a hot stove top or heated oven.
- Take care when moving the appliance, or removing accessories and food as hot oil or other hot liquids may be present.
- **DO NOT** clean the appliance with metal kitchen utensils, caustic or abrasive cleaning agents or scouring sponges.

- **DO NOT** place anything on top of the appliance.
- **DO NOT** use this appliance for anything other than its intended use.
- This appliance is for household use only.

## WHILST AIR FRYING

- Please ensure that the appliance is used on a stable, level, and heat resistant surface.
- **DO NOT** place the appliance on or near combustible materials such as a tablecloth or curtain.
- **DO NOT** place the appliance against a wall or against other appliances. Leave at least 10cm free space on the back and sides and 10cm free space above the appliance.

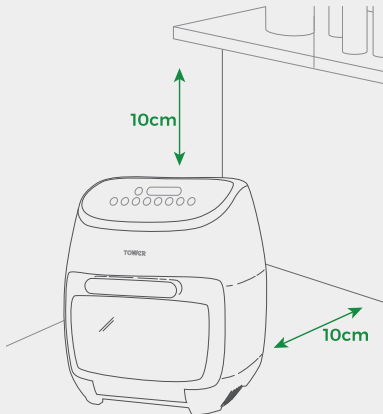

- **DO NOT** place the appliance in the presence of explosive and/or flammable fumes.
- **DO NOT** cover the air inlet and outlet during operation.
- Any accessories, baking trays or oven dishes used in the appliance will become hot. Always use oven gloves or the heat-proof silicone finger mitts when handling or removing anything from the appliance.
- **DO NOT** place food that is still packed in plastic wrap or plastic bags in the appliance.
- **DO NOT** allow food to come into contact with the heating element of the appliance.

- If the appliance begins to emit smoke, unplug it immediately. Only open the door once the smoke has cleared. Remove burnt remnants.
- **DO NOT** leave this appliance unattended whilst operating.

## PLUG AND CORD

- Check that the voltage of the main circuit corresponds with the rating of the appliance before operating.
- **WARNING: DO NOT** let the cord hang over the edge of a table or counter, serious burns may result from the air fryer being pulled off the counter where it may be grabbed by children or become entangled with the user.
- **DO NOT** let the supply cord touch hot surfaces.
- **DO NOT** carry the appliance by the power cord.
- **DO NOT** use any extension cord with this appliance.
- The appliance is not intended to be operated by means of an external timer or separate remote-control system.
- **DO NOT** pull the plug out by the cord as this may damage the plug and/or the cable.
- **DO NOT** plug and unplug with wet hands.

## WIRING SAFETY FOR UK USE ONLY

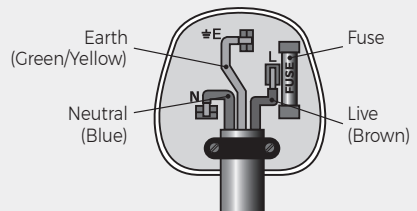

## IMPORTANT

As the colours in the mains lead of this appliance may not correspond with the coloured markings identifying the terminals in your plug, please proceed as follows:

The wires in the mains lead are labelled in accordance with the following code:

Blue neutral [N] Brown live [L] Green/  
Yellow [EARTH] 

## PLUG FITTING DETAILS (WHERE APPLICABLE)

- The wire labelled blue is the neutral and must be connected to the terminal marked [N].
- The wire labelled brown is the live wire and must be connected to the terminal marked [L].
- The wire labelled green/yellow must be connected to the terminal marked with the letter [E].
- On no account must either the brown or the blue wire be connected to the [EARTH] terminal.
- Always ensure that the cord grip is fastened correctly.
- The plug must be fitted with a fuse of the same rating already fitted and conforming to BS 1362 and be ASTA approved.
- If in doubt consult a qualified electrician who will be pleased to do this for you.

## NON-REWIREABLE MAINS PLUG

If your appliance is supplied with a non-rewireable plug fitted to the mains lead and should the fuse need replacing, you must use an ASTA approved one (conforming to BS 1362 of the same rating).

If in doubt, consult a qualified electrician who will be pleased to do this for you.

If you need to remove the plug - disconnect it from the mains - then cut it off of the mains lead and immediately dispose of it in a safe manner. Never attempt to reuse the plug or insert it into a socket outlet as there is a danger of an electric shock.

### **WARNING:**

**This appliance MUST be earthed!**

***In the unlikely event the appliance develops a fault, stop using it immediately and seek advice from the Customer Support Team. +44 (0) 333 220 6066***

# Getting to know your air fryer oven

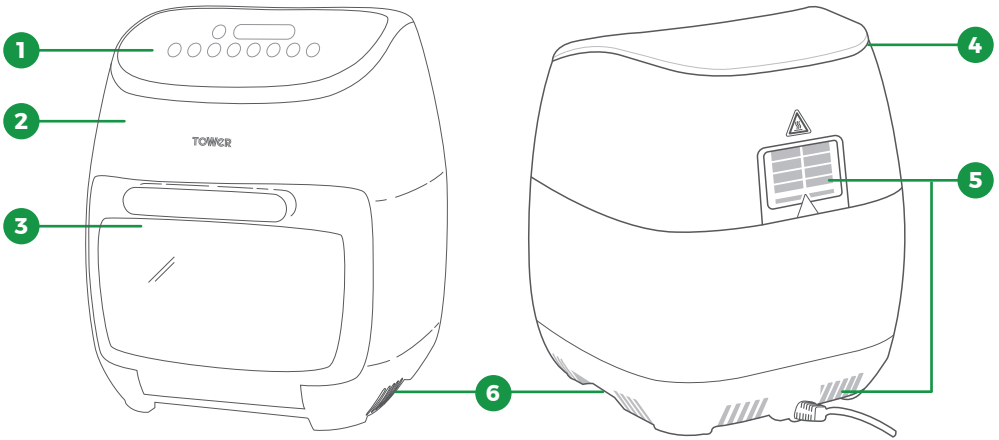

1. Control panel
2. Oven housing
3. Removable door
4. Air inlet
5. Air outlet
6. Carry handles
7. Oil drip tray
8. Rotisserie fork and handle
9. Air flow racks
10. Reversible grill plate
11. Wire rack
12. 10 skewers plus rotating wheels
13. Heat-proof silicone finger mitts

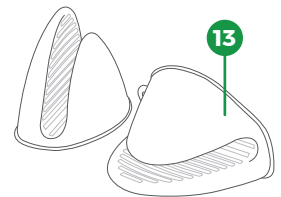
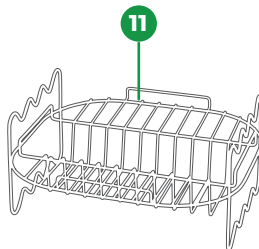
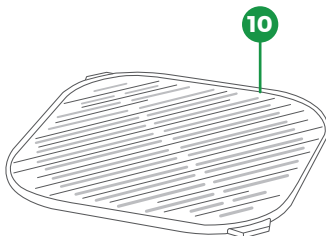
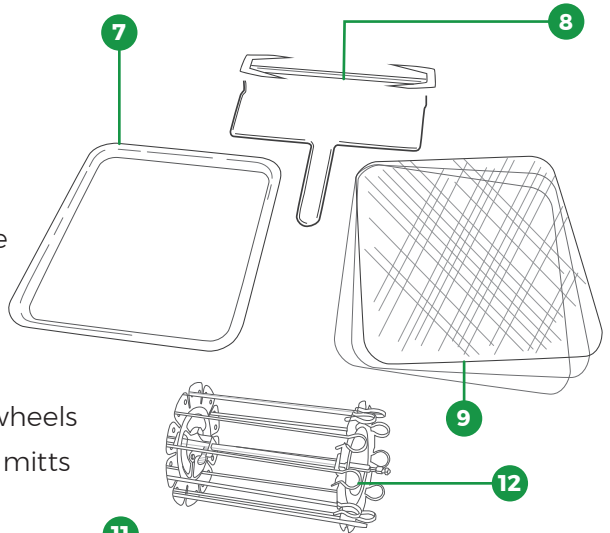



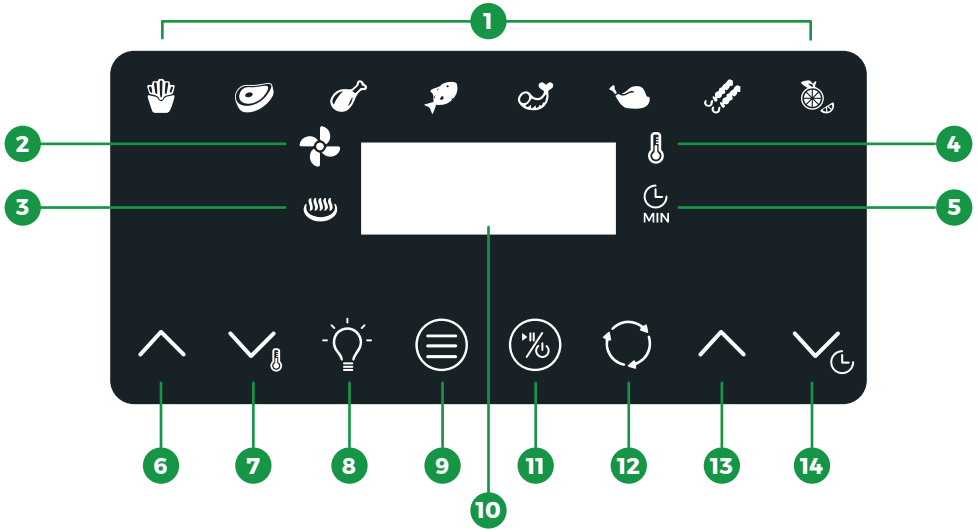





# CONTROL PANEL AND DISPLAY



1. Pre-set programs
2. Fan indicator
3. Heating indicator
4. Temperature indicator
5. Timer indicator
6. Temperature up key
7. Temperature down key
8. Light ON/OFF key
9. Mode key
10. LCD screen
11. ON/Pause key
12. Rotisserie ON/OFF key
13. Timer up key
14. Timer down key

## PRE-SET PROGRAMS

-  Fries
-  Steak / cutlets
-  Chicken fillets / drumsticks
-  Fish
-  Prawns
-  Roast chicken
-  Rotisserie
-  Dehydrate

**NOTE:** During operation, the heating indicator will turn on and off automatically, indicating that the heating element is switching on and off to maintain the set temperature.

**NOTE:** The time will increase/decrease in increments of 1 minute, from 1 to 60 minutes.

The temperature will increase/decrease in increments of 5 degrees, from 30°C to 200°C.

**NOTE:** Press and hold the timer/temperature arrow keys to change the time/temperature more quickly.

# Before first use

---

## SETTING UP

1. Remove your appliance from the packaging.
2. Check that there is no damage to the cord or any visible damage to the body.
3. Check that all listed parts are present.
4. Remove any stickers or labels from the appliance. **DO NOT** remove the rating plate or any warnings.
5. Dispose of the packaging in a responsible manner.
6. Locate the appliance on a stable, horizontal, even and heat-resistant surface in accordance with the **Important safety information** section.
7. Wash and dry the accessories and air fryer oven, following the instructions in the **Cleaning and care** section.

## TRIAL RUN

The appliance should be used for the first time without any food in it, in order to remove any manufacturing coating residues. The appliance may produce some smoke or odours during this process.

Allow the appliance to heat up on the highest temperature setting for approx. 15 minutes, with no food inside.

1. Connect the plug to a mains wall socket.
2. Close the appliance door.
3. Press the  key to bring up the touch control panel.

**NOTE:** *The appliance will automatically enter standby mode after 90 seconds if no keys are pressed after the control panel has illuminated.*

4. Press the timer arrow keys to adjust the operating time to 15 minutes.
5. Press the temperature arrow keys to adjust the temperature setting to 200°C.
6. Press the  key.

The heating element and fan will begin to operate, the fan and heating indicators will illuminate and the timer will begin counting down.

7. When the set time has elapsed, the appliance will emit a series of beeps, the screen will display '00', and the screen and the  key will flash.
8. Remove the plug from the mains power socket.
9. Allow the appliance to cool down.

# Using your air fryer oven

The appliance is suitable for frying, roasting, baking, grilling, drying or warming food.

## USING THE ACCESSORIES

### Oil drip tray:

Insert the oil drip tray into the bottom of the cooking space for food residues such as dripping fat or crumbs to collect in.

### Air flow racks:

1. The air flow racks are intended for drying. However, they can also be used for crisping, warming up etc.
2. Slide the air flow racks onto the rails in the cooking space.

The heating element is located at the top of the cooking space. Therefore, the higher up an air flow rack is placed the more intense the heat is from above.

- In the top section, the food is cooked faster and crispier.
- The middle position should be chosen to achieve even heating from all sides.
- The bottom rails are suitable for gentle cooking.

### Rotisserie:

The rotisserie fork consists of the shaft and two rotisserie fork heads. The rotisserie is suitable for grilling large pieces of meat, e.g. chicken, pork with a maximum weight 1.3Kg.

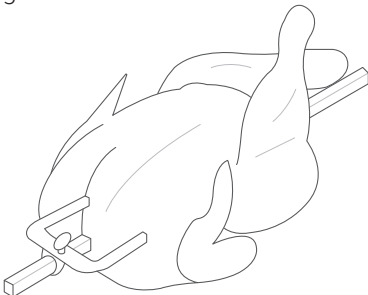

Assemble the rotisserie fork and insert it into the appliance:

1. Slide one of the rotisserie fork heads onto the shaft and secure in place with the locking screw.
2. Slide the food for grilling onto the shaft.
3. Slide the other rotisserie fork head onto the shaft and food and secure in place with the locking screw.
4. Push one end of the shaft into the round holder on the side of the cooking space. Then hang the other end of the shaft into the support on the opposite side of the cooking space.
5. Check that it fits securely. The rotisserie fork must not be able to rotate about its own axis when the appliance is switched off. If this is not the case, push the shaft deeper into the round holder.
6. Once the rotisserie fork is installed, press the  key on the unit's control panel to activate the rotation function. If the rotisserie has been installed correctly, it will begin to rotate.

If the rotisserie fork does not begin to rotate once the key has been pressed, pull it out of the air fryer and repeat the steps detailed above, taking care to ensure the shaft is pushed all the way into the slot on the body of the appliance.

7. After use, remove the hot rotisserie fork from the cooking space using the handle (see the **Rotisserie handle section**).

**CAUTION:** Wear oven gloves or the heat-proof silicone finger mitts to remove the rotisserie forks.

### Guidance notes:

- The shaft contains a small round notch for the tip of the locking screw. In the case of smaller pieces of food, the rotisserie fork heads can be secured more centrally on the shaft. (see *illustration A*)

### illustration A



- The shaft contains two small round notches marking the outermost position of the locking screws. The locking screws must not be attached any further than the outer ends of the shaft to ensure smooth operation.
- **DO NOT** place any pieces of meat that are too large onto the rotisserie fork as this could hinder rotation. It may be necessary to truss a chicken.
- The  key can be pressed at any time during cooking to stop rotation, if required.

### Rotisserie handle:

Use the rotisserie handle to remove the rotisserie from the cooking space:

1. Place the ends of the rotisserie handle under the shaft.
2. First lift the shaft from the support and pull it forwards a little until the other end of the shaft is released from the holder.
3. Carefully lift the rotisserie out of the cooking space and place down on a heat-resistant surface.

### Kebab skewers

Assemble the skewer rack:

1. Place the skewer rack discs onto the shaft, ensuring the flat faces of the discs face inwards.
2. Thread food onto the separate skewers and place onto the skewer rack by slotting the sharp end of the skewer into the narrow slot and the hooked end of the skewer into the shaped slots. Squeeze and tilt the hook downwards to lock into place.
3. Place the rack into the oven. Insert the shaft end with just one notch into the holder on the side of the oven walls. Push into the holder as far as it will go.

4. Hang the other end of the shaft (with two notches) into the support on the opposite side of the oven.
  5. Check that the rack fits securely. It must not be able to rotate about its own axis when the appliance is switched off. If this is not the case, push the shaft deeper into the holder.
  6. After use, remove the rack using the handle (see the **Rotisserie handle** section).
- CAUTION:** Wear oven gloves or the heat-proof silicone finger mitts to remove the rack and the grilled items.
7. Squeeze and tilt the hook upwards to remove the skewers from the rack.

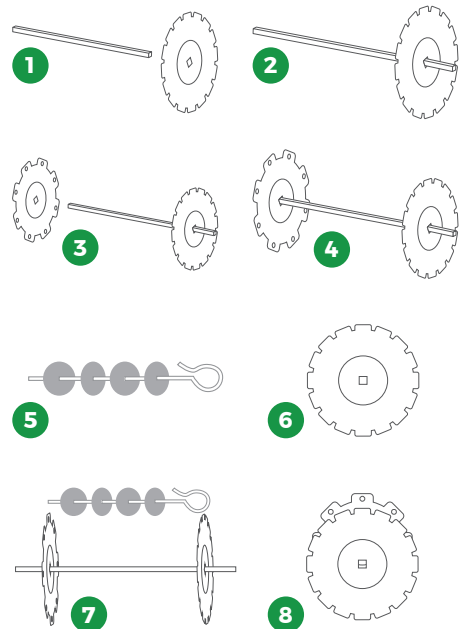

### Heat-proof silicone finger mitts

Use the flexible silicone finger mitts to protect from burns when putting food into and removing food from a hot oven.

## Frying basket (optional accessory):

The rotating basket turns during cooking to ensure that the food crisps on all sides. The rotating basket is particularly suitable for preparing chips or other potato products, small pieces of vegetables and meat as well as frozen products, such as chicken nuggets or onion rings.

1. Place the shaft through the basket so that the shaft end with one notch exits the side of the basket with the L shaped metal attachment.
2. Open the rotating basket.
3. Place food into the rotating basket. To ensure food is cooked evenly, the basket should be no more than  $\frac{3}{4}$  full with food.
4. Close the basket, ensuring that the catch is shut.
5. Insert the side of the rotating basket with the L shaped metal attachment and the shaft end with just one notch into the holder on the side of the oven walls. Push into the holder as far as it will go.
6. Hang the other end of the shaft (with two notches) into the support on opposite side of the cooking space.
7. Check that the rotating basket fits securely. It must not be able to rotate about its own axis when the appliance is switched off. If this is not the case, push the shaft deeper into the holder.
8. After use, remove the hot rotating basket from the cooking space using the handle (see the **Rotisserie handle** section).

**CAUTION:** Wear oven gloves or the heat proof silicone finger mitts to open and empty the rotating basket.

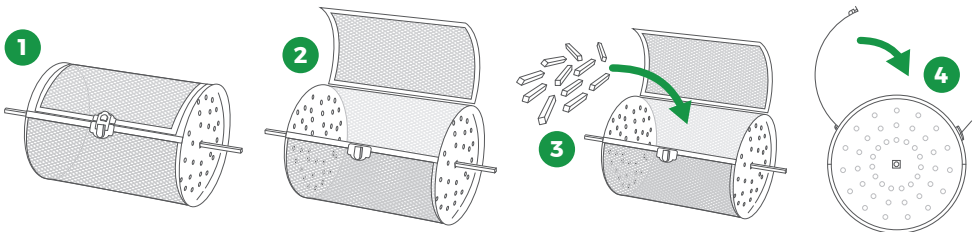

## Reversible grill plate:

The grill plate is flat on one side and is ideal for cooking fresh or frozen pizzas. The reverse side of the grill plate is ridged, allowing food to be griddled for chargrill style steaks, burgers, fish etc. Place the grill plate on to the wire rack and stand on the drip tray. Lay the food on top of the plate.

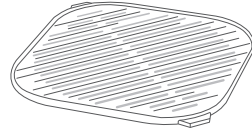

**NOTE:** Do not use metal objects to remove food from the grill plate as you may damage the non-stick coating

**CAUTION:** Wear oven gloves or the heat-proof silicone finger mitts to remove the wire rack and grill plate. And place on a heat proof surface Allow the grill plate to cool before handling and washing.

## Wire rack:

Use the wire rack as a:

- Stand for the reversible grill plate
- Toast rack. Stand the bread in the slots of the rack.
- Grill. Lay food directly on to the wire rack.

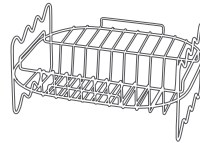

Stand the wire rack on the drip tray.

**CAUTION:** Wear oven gloves or the heat-proof silicone finger mitts to remove the wire rack and place on a heat proof surface. Allow the rack to cool before handling and washing.

## COOKING WITH THE AIR FRYER OVEN:

**DO NOT** put anything on top of the appliance, as this will disrupt the airflow and the hot air frying will be affected as a result

- This air fryer oven operates using hot air and requires very little to no oil.
- Rapid Air technology instantly reheats the air inside the appliance therefore opening the door briefly during hot air frying barely disturbs the process.

**NOTE:** The appliance door must be closed for keys to be active.

1. Connect the plug to a mains wall socket.
2. Slide the oil drip tray into the bottom of the cooking space.
3. Select a suitable accessory for the food that is to be prepared, such as a small cooking dish to place on an air flow rack or a chosen appliance accessory.
4. Place the food into the air fryer oven.
5. Close the door. The air fryer oven will emit an audible sound and all the indicators will light up momentarily.
6. The  key will remain illuminated to indicate the appliance is turned on but in Standby mode. Press this key at any time while the air fryer oven is in stand-by mode to bring up the touch control panel.

**NOTE:** The air fryer oven will automatically enter standby mode after 90 seconds of inactivity, if no keys are pressed or selections made after the control panel has illuminated.

7. Determine the required cooking time for your desired ingredients (refer to the **Settings and pre-set programs** section).

Use the timer arrow keys to adjust the cooking time accordingly.

**NOTE:** Cooking times can be changed or adjusted, even while the air fryer oven is in operation.

8. Determine the required cooking temperature (refer to the **Settings and pre-set programs** section).

Use the temperature arrow keys to adjust the temperature accordingly.

**NOTE:** The temperature can be adjusted or changed at any time, even while the air fryer oven is in operation.

9. Once the correct pre-set program/ time/temperature have been set, press the  key.

The heating element and fan will begin to work, the fan and heating indicators will illuminate and the timer will start counting down the remaining cooking time.

**CAUTION:** During the frying process, food will get very hot and steam may escape from the appliance.

10. When the set cooking time has elapsed, the air fryer oven will emit a series of beeps, the screen will display '00', and the screen and the  key will flash.
11. Open the air fryer oven door and check if the food is ready.

Always wear oven gloves or the heat-proof silicone finger mitts and use suitable accessories such as tongs or the rotisserie handle, as required.

**NOTE:** Always place the hot accessories on a heat-resistant surface.

**CAUTION:** Before serving, ensure meat and poultry are thoroughly cooked.

12. If the food is not ready, simply place it back into the air fryer oven, close the door, then set the timer for a few extra minutes.
13. Once food is cooked and the appliance is not required for further cooking, remove the plug from the mains power socket.
14. Allow the used accessories and appliance to cool down before cleaning them (refer to the **cleaning and care** section).

## SETTINGS AND PRE-SET PROGRAMS:

- The settings table will help you to select the basic settings for the ingredients.
- Settings and pre-set programs are indications; as ingredients differ in origin, size, shape and brand, we cannot guarantee the best settings for your ingredients.
- Settings can be adjusted to meet personal preference in the finished result. However, always ensure food is cooked and piping hot before serving.
- During cooking, it may be necessary to rotate the racks once, to ensure even cooking, if cooking food on more than one shelf.

## Settings

Food	Weight (g)	Cooking Time (mins)	Temp (°C)	Extra information
<i>Hamburger</i>	400-800	10-15	180	
<i>Homemade chips</i>	800	20	180	Add some oil to fresh potatoes for a crispy result. For best fluffy results, parboil the potatoes before air frying.
<i>Spring rolls</i>	500-800	8-10	200	
<i>Frozen chicken nuggets</i>	500-1000	6-10	200	
<i>Frozen fish fingers</i>	500-800	6-10	200	
<i>Stuffed vegetables</i>	400-800	10	160	Dependant on vegetable type e.g. a stuffed pepper will take longer than a stuffed mushroom
<i>Cake</i>	800	25-35	160	
<i>Quiche</i>	800	20-22	190-200	Dependant on the filling and whether the pastry has been pre baked. Pastry needs to be cooked at a slightly higher temperature.
<i>Muffins</i>	800	18-20	180	Dependent on the recipe
<i>Bread Dough</i>	800	25	190	
<b>TOAST</b> <i>Sliced bread, bagels, crumpets, muffins, teacakes.</i>	Min 1 slice Max 8 slices of bread	8-10 minutes Do not pre heat the wire rack	190 - 200	Adjust the cooking time and temperature depending on the thickness of the bread or bakery product and how well browned you like it.  For best results and even toasting place up to 4 slices of bread in the wire rack.  The more pieces in the slots the longer the toasting process takes and the bread will require turning.  Thicker bread works better than pre-cut medium/ thin sliced bread. Thinner bread will produce very crisp toast.  For larger bread and bakery products place the item horizontally on the toast rack so that the bread or bakery product does not touch the top of the oven.  Sit the wire rack on the drip tray before inserting into the base of the air fryer.









Food	Weight (g)	Cooking Time (mins)	Temp (°C)	Extra information
<p><b>PIZZA</b></p> <p><i>Topped pre-cooked pizza bases, ready prepared fresh pizza</i></p> <p><i>Frozen ready prepared pizza</i></p> <p><i>Fresh pizza dough, topped</i></p>	<p>Max 1 x 20cm pizza</p>	<p>10 -12 minutes</p> <p>12 minutes</p> <p>12-15 minutes</p>	190	<p>Adjust the cooking time depending on the type and thickness of pizza and how well you like it cooked, e.g., fresh pizza dough will take longer to cook than a pre-cooked pizza base.</p> <p>Sit the wire rack and grill plate on the drip tray before inserting into the base of the air fryer.</p> <p>For best results preheat the flat side of the reversible grill plate for 3 minutes before cooking the pizza.</p> <p><b>NOTE:</b> <i>It is not necessary to grease the grill plate.</i></p>
<p><b>GRILL</b></p> <p><i>Steak, chicken, sausages, burgers, fish</i></p>	<p>E.g. max amounts</p> <p>2 x 227g steaks</p> <p>2 x butterflied chicken breasts</p> <p>6 sausages</p>	12-20 minutes	180	<p>Adjust the cooking time depending on the type and thickness of meat or fish and how well you like it cooked, e.g., fresh fish will take less time to cook than sausages.</p> <p>Sit the wire rack and grill plate on the drip tray before inserting into the base of the air fryer.</p> <p>For best results preheat the flat side of the reversible grill plate for 3 minutes before cooking food.</p> <p>Lightly oil the food with spray vegetable oil before placing on the hot grill plate.</p> <p>It may not be necessary to turn the food during cooking.</p> <p>Ensure that chicken is well cooked, and juices run clear, extend the cooking time if required.</p>
<p><b>GRIDDLE</b></p> <p><i>Chargrilled steak, burgers, fish, chicken, vegetables, halloumi</i></p>		12-20 minutes	180	<p>Adjust the cooking time depending on the type and thickness of meat or fish and how well you like it cooked, e.g., fresh fish will take less time to cook than chicken.</p> <p>Sit the wire rack and grill plate on the drip tray before inserting into the base of the air fryer.</p> <p>For best results preheat the ridged side of the reversible grill plate for 3 minutes before cooking food.</p> <p>Lightly oil the food with spray vegetable oil before placing on the hot chargrill plate.</p> <p>To achieve griddle marks on both sides of the food turn the food once halfway through cooking.</p> <p><b>NOTE:</b> <i>Chargrill lines are more visible on lighter coloured food items such as chicken and fish.</i></p> <p>Ensure that chicken is well cooked, and juices run clear, extend the cooking time if required.</p>

## Settings Continued

Food	Weight (g)	Cooking Time (mins)	Temp (°C)	Extra information
<b>KEBAB</b> <i>Chicken, meat, fish, prawns, vegetables, halloumi, paneer.</i>	10 skewer rotating wheel	20 minutes	200	Adjust the cooking time depending on the type and thickness of food and how well you like it cooked, e.g., fresh fish skewers will take less time to cook than chicken.  Lightly oil the kebabs with spray vegetable oil.  Ensure that chicken is well cooked, and juices run clear, extend the cooking time if required.

### Pre-set programs:

- This air fryer oven is equipped with 8 pre-programmed settings ideal for the most commonly air-fried meals. When one of these menus is selected, the air fryer oven will automatically default to that program's pre-set temperature and time, and operate accordingly.
- Each of these programs can be accessed by pressing the  key, followed by the key to the program required, on the unit's control panel. The corresponding indicator will illuminate to show the program selected.
- It is possible to change the pre-set temperature and time, as required, by using the temperature and timer increase/decrease keys.

	Programs	Weight (g)	Temp (°C)	Cooking time (mins)	Extra information
	<i>Frozen fries</i>	550	180	20	If fries are not golden brown or cooked to desired level, cook for a further 5 minutes.
	<i>Frozen chips</i>	550	180	20	If cooking more than 1 rack of chips, rotate the racks during cooking.
	<i>Steak / cutlets</i>	2 portions	180	20	Adjust the cooking time depending on the thickness of the meat and how well you like it cooked, e.g. rare will require less than the pre-set time. Example: 2 rump steaks - to produce a medium steak cook the meat from room temperature at 180C for 5 minutes each side, on the air flow tray on the top shelf. Then rest for 5-10 minutes covered with foil. If cooking four steaks rotate the racks to produce even cooking.
	<i>Chicken fillets/ drumsticks</i>	4 portions	180	30	Ensure the chicken is well cooked and juices run clear, extend the cooking time if required. To achieve even cooking when cooking 4 portions rotate the air flow racks. If cooking on a single shelf use the top shelf position if the chicken is uncoated and the middle shelf for coated chicken.
	<i>Fish</i>	4 salmon fillets	180	20	Cooking time can vary depending on the variety of fish and the thickness of the fillets. Use the top shelf.
	<i>Prawns</i>	1 tray	160	12	Without a crispy coating.
	<i>Roast chicken</i>	1.3Kg	200	40	If cooking the chicken on an airflow rack, after pressing the roast chicken function option, press the rotisserie button to cancel the rotisserie function. If using the rotisserie function with this setting it may be necessary to truss the chicken to prevent the legs/wings catching the sides of the oven. Ensure the chicken is well cooked and juices run clear, extend the cooking time if required.
	<i>Rotisserie</i>		200	20	Some meats may require the cooking time to be extended
	<i>Dehydrate</i> <i>Dried fruit</i> <i>e.g. apple, mango, peach, pineapple, banana, pineapple, strawberry</i>	A single, even layer of fruit	45	4 hours	Use an air flow rack. Keep a little space in the middle of the rack to facilitate the circulation of hot air. Cooking time will be dependent on the moisture level of the fruit. Cut into thin slices of about 5mm.

## PRE-HEATING:

Some food is best cooked once the air fryer oven has been pre-heated (until the heating indicator goes off):

Food Type	Pre-heat Temp (°C)	Pre-heat Time (approx.)
Cakes	160	2 minutes
Cookies/ muffins	180	2 minutes 30 seconds
Breads/ pastries	190/200	3 minutes

## GETTING THE BEST RESULTS FROM YOUR AIR FRYER OVEN:

### Cooking time:

- The cooking time will depend on the size of your ingredients. Smaller sizes may require a shorter cooking time.
- In general the cooking times are shorter than in a conventional oven. Start with shorter cooking times and then adapt the cooking times to your personal taste.
- Whilst becoming familiar with the appliance it is advisable to check the condition of the food during cooking to ensure that it does not burn. To do this, open the air fryer oven door or switch on the light using the  key.

### Turning and rotating food:

- “Flipping” or turning smaller sized foods halfway through the cooking process, assures that all the pieces are evenly fried.
- It may be necessary to rotate the air flow racks during the cooking process in order to ensure even cooking of all foods. **Air Flow Racks** in the **Using the Accessories** section details the heat variations within the appliance.

### Accessories:

- If using a cooking vessel on the air flow racks, non-stick coated or enamel coated ovenware is recommended in order to allow for greater heat transfer. **NOTE:** Using cooking vessels may affect the cooking due to the reduction in air flow.
- If using air flow racks without a cooking vessel keep in mind that food residues may drip on to food items on shelves below.

### Food tips:

- Snacks that can be prepared in an oven can also be prepared in the air fryer oven.
- There is no need to add any oil to frozen chips as most frozen products are generally pre-fried. When preparing frozen chips or other frozen convenience products, follow the manufacturer’s specifications on the packaging. Be cautious of using extremely greasy ingredients such as sausages in the air fryer oven.
- The air fryer oven can be used to reheat food; Set the temperature to 150°C for up to 10 minutes.

## WEIGHTS AND MEASURES

Check these charts for basic imperial to metric conversions of weights

Metric	Imperial	US cups
250ml	8 fl oz	1 cup
180ml	6 fl oz	3/4 cup
150ml	5 fl oz	2/3 cup
120ml	4 fl oz	1/2 cup
75ml	2 ½ fl oz	1/3 cup
60ml	2 fl oz	1/4 cup
30ml	1 fl oz	1/8 cup
15ml	1/2 fl oz	1 tablespoon

Imperial	Metric
1/2 oz	15g
1 oz	30g
2 oz	60g
3 oz	90g
4 oz	110g
5 oz	140g
6 oz	170g
7 oz	200g
8 oz	225g
9 oz	255g
10 oz	280g
11 oz	310g
12 oz	340g
13 oz	370g
14 oz	400g
16 oz	425g
1 lb oz	450g

## ADDITIONAL FUNCTIONS

### Pausing:

Press and hold the  key while the air fryer oven is in operation to pause the cooking cycle.

The fan and heating element will stop working and the corresponding indicators in the touch control panel will go out to indicate operation has been paused.

Press this key again while the air fryer oven is in this state to resume cooking.

### Automatically resume cooking:

If the door is opened during cooking, the screen and power light will go off, and the heating element and fan will stop working.

When the door is closed again, the air fryer oven will resume operation in its latest settings. The cooking time countdown will not be affected, as the air fryer oven has a memory backup of up to 2 hours.

### Turning the light on and off:

Press the  key to turn the appliance's inner light ON or OFF at any time.

### Automatic switch off:

The air fryer oven has a built in timer, which will automatically shut off the appliance when the timer reaches zero. The air fryer oven can be manually switched off by pressing the  key until the timer reaches zero.

# Accessories/Spare Parts

Spare part replacements and accessories are available to purchase via:

 **+44 (0) 333 220 6066**

 **[www.towerhousewares.co.uk](http://www.towerhousewares.co.uk)**

PART NO	DESCRIPTION	IMAGE
T1707601	Air Flow Rack	
T1707602	Oil Drip Tray	
T1707603	Rotisserie Fork	
T1707604	Rotisserie Handle	
T1707605	Reversible Grill Plate	
T1707606	Toasting Rack	
T1707608	Rotating Basket	
T1707609	Rotating Kebab Skewers	
T17038009	Heat-proof Silicone Finger Mitts	

# Cleaning and care

**Warning!** Do not immerse the appliance in water or any other liquid.

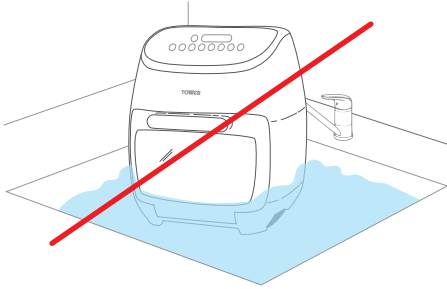

Clean the main unit and the used accessories after each use. **DO NOT** allow food residues to dry on. Food residue could start to burn and possibly cause faults.

1. Unplug the appliance from the mains and allow it to cool down.

**NOTE:** Open the air fryer oven door to let it cool down more quickly.

2. Wipe the main unit clean with a damp cloth and a little detergent.
3. Clean all other used accessories with detergent and warm water. In the case of stubborn dirt, soak the accessories in warm water and detergent beforehand.

**NOTE: DO NOT** clean the appliance with metal kitchen utensils, caustic or abrasive cleaning agents or scouring sponges.

**NOTE:** Allow all parts to air dry completely or dry with a tea towel before reusing or storing.

## Removing the Door

The air fryer oven has a removable door, which can be detached from the appliance for easier cleaning.

### To separate the door from the air fryer oven:

1. Push the door as far down as it will go (about 70 degrees).
2. Push the grooved latch on the right-hand side of the hinge horizontally to release the door.
3. Once the door has been released, pull it downward to separate it from the body of the appliance.

### To reinstall the door:

1. Push the locking tab to the side to unlock the pins on either side of the door.
2. Position the door underneath the air fryer oven and bring it up and inwards, aligning the pin on the left-hand side of the door in first.
3. Once the left pin is securely slotted into place, insert the right-hand pin into its corresponding hole in a similar manner.
4. Release the locking tab to secure the door into place.

**NOTE: ALWAYS** take care to come in from the bottom of the unit and move from left to right when installing the door. Attempting to install the door from the top down or moving from right to left will cause it to be incorrectly fitted, and may cause damage to the hinge mechanism.

## Storage

- Once cool, clean and dry store the appliance upright, in a cool, dry place.



# Troubleshooting

PROBLEM	POSSIBLE SOLUTION
The air fryer does not work	Plug the appliance into an earthed wall socket
	Press the  to switch on the appliance
The air fryer is emitting smoke	White smoke is caused by grease heating up inside the appliance. Clean the appliance properly after each use.
	Dark smoke suggests food is burning. Immediately unplug the appliance. Wait for smoke to clear before opening the oven door.
Foods are overcooked or burned	Decrease cooking temperature or time
	Ensure food items are not too large and are not touching the heating elements
The fried ingredients are not done	Put smaller batches of ingredients in the air fryer. Smaller batches are fried more evenly
	The set temperature is too low. Adjust the temperature. Refer to the <b>Settings and Pre-set Programs</b> section under <b>Cooking with the Air Fryer Oven</b> for a temperature reference guide
	The cooking time is too short. Adjust the cooking time (Refer to the <b>Settings and Pre-set Programs</b> section under <b>Cooking with the Air Fryer Oven</b> for a timer reference guide)
French fries are fried unevenly in the air fryer	Use fresh starchy potatoes and make sure they stay firm during frying
	Rinse the potato sticks properly to remove starch from the outside
French fries are not crispy when they come out of the air fryer	The crispiness of the fries depends on the amount of oil and water in the fries.
	Dry the potato sticks properly before you add the oil.
	Cut the potato sticks smaller for a crispier result.
	Add slightly more oil for a crispier result.

# Disposal of the unit

---

Appliances bearing the symbol shown here may not be disposed of in domestic rubbish. You are required to dispose of old electrical and electronic appliances like this separately.

Please visit [www.recycle-more.co.uk](http://www.recycle-more.co.uk) or [www.recyclenow.co.uk](http://www.recyclenow.co.uk) for access to information about the recycling of electrical items.

Please visit [www.weeeireland.ie](http://www.weeeireland.ie) for access to information about the recycling of electrical items purchased in Ireland.

The WEEE directive, introduced in August 2006, states that all electrical items must be recycled, rather than taken to landfill.

Please arrange to take this appliance to your local Civic Amenity site for recycling, once it has reached the end of its life.



# Customer support

---

If you have any questions or concerns about your new product, please contact our helpful Customer Support Team:



**+44 (0) 333 220 6066**



**[www.towerhousewares.co.uk](http://www.towerhousewares.co.uk)**

Please have your Model No. available. This can be found on the front cover of this instruction manual and on the appliance's rating label.

**TOWER**<sup>®</sup>  
over 100 YEARS of quality

**XpressPro**  
COMBO



*Thank you!*



*We hope you enjoy your appliance for many years...*

This product is guaranteed for 12 months from the date of original purchase.

If any defect arises due to faulty materials of workmanship, the faulty products must be returned to the place of purchase.

Refund or replacement is at the discretion of the retailer.

**THE FOLLOWING CONDITIONS APPLY:**

The product must be returned to the retailer with proof of purchase or a receipt.

The product must be installed and used in accordance with the instructions contained in this instruction guide.

It must be used only for domestic purposes.

It does not cover wear and tear, damage, misuse or consumable parts.

Tower has limited liability for incidental or consequential loss or damage.

This guarantee is valid in the UK and Eire only.

**The standard one year guarantee is only extended to the maximum available for each particular product upon registration of the product within 28 days of purchase. If you do not register the product with us within the 28 day period, your product is guaranteed for 1 year only.**

To validate your extended warranty, please visit **[www.towerhousewares.co.uk](http://www.towerhousewares.co.uk)** and register with us online.

Please note that length of extended warranty offered is dependent on product type and that each qualifying product needs to be registered individually in order to extend its warranty past the standard 1 year.

Extended warranty is only valid with proof of purchase or receipt.

Your warranty becomes void should you decide to use non Tower spare parts.

Spare parts can be purchased from **[www.towerhousewares.co.uk](http://www.towerhousewares.co.uk)**

Or call our Customer Support Team on:

**+44 (0) 333 220 6066**

