

Owners Manual

Product Code: 1032T

**MADE FOR THE
TRADE**

TQ TRADEQUIP
the trusted brand in equipment

**PORTABLE INDUSTRIAL
SPOT COOLING AIR
CONDITIONER**



Specifications:

- Cooling Capacity: 4.5KW / 15300Btu
- Power Unit: 240V 50Hz
- Rated Power: 2120W
- Rated Current: 9.2A
- Max. Air Flow: 800m³ per hour
- Noise Level: 60dB(A)
- Operating Temperature: 18° - 45°C
- Suction Pressure: 2.5Mpa (Max.)
- Discharge Pressure: 4.5Mpa (Max.)
- Speed Control: 2-speed
- Refrigerant: R410/800g
- Condensation Tank Capacity: 8 Litres
- Castor Wheels: 75mm Dia (2 with brakes)
- Dimension: 1035(H) x 520(W) x 480(D)
- Nett Weight 67kg
- Carton 1of2: 1100 x 610 x 570mm
- Carton 2of2: 370 x 350 x 260mm
- Gross Weight 72kg

About the **TradeQuip** brand

The '**TradeQuip**' brand of workshop equipment, is designed for use in a demanding workshop environment by professional users. With proven and trusted "**Made for the Trade**" reliability, '**TradeQuip**' branded products offer the very best in performance for an affordable price. All backed by a 1year trade guarantee across 1,000+ distributors Australia wide.

TQ TRADEQUIP
the trusted brand in equipment

TQPRO
Trusted by serious professionals

BORUM
INDUSTRIAL WORKSHOP EQUIPMENT





WARNING**IMPORTANT: READ ALL INSTRUCTIONS BEFORE USE** **WARNING**

The instructions and warnings contained in this manual should be read and understood before using or operating this equipment. Do not allow anyone to use or operate this equipment until they have read this manual and have developed a thorough understanding of how this equipment works. Failure to observe any of the instructions contained in the manual could result in severe personal injury to the user or bystanders, or cause damage to the equipment and property. Keep this manual in a convenient and safe place for future reference.

Whilst every effort has been made to ensure accuracy of information contained in this manual, the TQB Brands Pty Ltd policy of continuous improvement determines the right to make modifications without prior warning.





Safety Signs and Precautions















- Meaning and identification of signs
- Please read the safety signs and precautions carefully before using the machine











 Danger	Incorrect use while ignoring the sign may cause casualty accident, fire and other property losses.
 Warning	Incorrect use while ignoring the sign may cause casualty accident, fire and other property losses.
 Forbidden	The sign indicates actions that are forbidden.
 Constraint	The sign indicates constraint and instruction.
 Attention	The sign indicates and urges to notice the contents.

The points raised in the below table may lead to serious consequences under varying circumstances

We encourage you to carefully review all records and take note of the details

	If the supply cord is damaged, it must be replaced by a special cord or assembly available from the manufacturer or its service agent.
	This appliance can be used by children aged from 8 years and above and persons with reduced physical, sensory or mental capabilities or lack of experience and knowledge if they have been given supervision or instruction concerning use of the appliance in a safe way and understand the hazards involved
	Children shall not play with the appliance
	Cleaning and user maintenance shall not be made by children without supervision

	This appliance is intended to be used by expert or trained users in shops, in light industry and on farms, or for commercial use by lay persons
	Disconnect the appliance from its power source during service and when replacing parts
	Please do not use the spot cooler in the places where the use or storage of volatile substances (such as diluents, gasoline, kerosene, liquefied gas and other volatile liquids, volatile dust and steam of magnesium, aluminum, lead and other metals) in case of ignition, explosion, fire, burn or other dangers.
	Please do not modify it, or it will lead to machine damage and even fire and other dangers.
	Except for professional maintenance personnel, other personnel are not allowed to assemble or disassemble to avoid fire, electrocution, injury and other safety accidents. If repair is needed, please contact the after-sales service department at the place of purchase.
	Please do not use it in places with rain and snow water. Do not operate with wet hands.
	Please use 220-240V~ 50Hz, power supply; Otherwise there might be machine breakdown or safety accident.
	Please separately use socket of 10A rated current. Use of socket with other electrical appliances may cause error.
	Please do assign professionals to operate according to equipment standard and wiring upon installation; Otherwise there may be safety accident.
	Please keep any required ventilation openings clear of obstruction.
	To prevent deformation of the machine, No open flames, cigarettes or other possible sources of ignition should be used in the vicinity of the machine.
	Please equip safe and reliable ground lead and use leakage protector.
	Please use it in specified range of 18°C~45°C; otherwise there may be machine breakdown.
	Do not move air cooler when the machine is running and set the brake of trundle to locked status.
	Please immediately stop using it in case of error (stopped rotation, strange noise, improper vibration and unusual odor).

	<p>To prevent disaster and damage, air cooler cannot be used in the following places:</p> <p>Vibrating floor Gradient floor Stairway, emergency exit and house exit and entrance, etc Place with unstable articles piled around Windy and moist place or place with floating metal powder</p>
	<p>Please grip the plug when pulling it off instead of pulling the power line directly. Otherwise it may damage the plug, or cause sparkle or safety accident.</p>
	<p>Please pull the power plug off the socket if the machine is not used for long terms.</p>
	<p>To prevent electrocution, please pull the power plug off the socket upon installation and maintenance.</p>
	<p>Please use dry and clean cloth to rub down the dust on power plug on schedule. Dusty or moist plug may cause poor contact or electric leakage, leading to safety accident.</p>
	<p>Do not haphazardly bend, drag, twist, pinch or change the power line. Do not overload the power line. Otherwise there may be fire, electrocution and other accidents.</p>
	<p>Please do not use it as air conditioner for boat and vehicle, etc. Otherwise there may be safety accident.</p>
	<p>Please do not stick finger or hand in the vent.</p>
	<p>This unit uses a flammable refrigerant. If refrigerant leaks and comes in contact with fire or heating part, it will create harmful gas and there is risk of fire.</p>
	<p>Read the USER MANUAL carefully before operation.</p>
	<p>Service personnel are required to carefully read the USER MANUAL and SERVICE MANUAL before operation.</p>

WARNING

Do not use means to accelerate the defrosting process or to clean, other than those recommended by the manufacturer.

The appliance shall be stored in a room without continuously operating ignition sources (for example: open flames, an operating gas appliance or an operating electric heater).

Do not pierce or burn.

Be aware that refrigerants might not contain an odour.



Warning on Refrigerant R32

- The machine is designed only for use with R32 gas as the designated refrigerant.
- **THE REFRIGERANT LOOP IS SEALED. ONLY A QUALIFIED TECHNICIAN SHOULD ATTEMPT TO SERVICE!**
- Component parts are designed non-incident and non-sparking. Component parts shall only be replaced with identical repair parts.

SAFETY REGULATIONS FOR SERVICE AND REPAIR WORK

Repairs must only be carried out by authorized service personnel and only using genuine spare parts.

1. Checks to the Area

Prior to beginning work on systems containing flammable refrigerants, safety checks are necessary to ensure that the risk of ignition is minimised. For repair to the refrigerating system, the following precautions shall be complied with prior to conducting work on the system.

2. Work procedure

Work shall be undertaken under a controlled procedure so as to minimise the risk of a flammable gas or vapour being present while the work is being performed.

3. General work Area

All maintenance staff and others working in the local area shall be instructed on the nature of work being carried out. Work in confined spaces shall be avoided. The area around the workspace shall be sectioned off. Ensure that the conditions within the area have been made safe by control of flammable material.

4. Checking for presence of refrigerant

The area shall be checked with an appropriate refrigerant detector prior to and during work, to ensure the technician is aware of potentially flammable atmospheres. Ensure that the leak detection equipment being used is suitable for use with flammable refrigerants, i.e. non-sparking, adequately sealed or intrinsically safe.

5. Presence of fire extinguisher

If any hot work is to be conducted on the refrigeration equipment or any associated parts appropriate fire extinguishing equipment shall be available to hand. Have a dry powder or CO₂

fire extinguisher adjacent to the charging area.

6. No ignition sources

No person carrying out work in relation to a refrigeration system which involves exposing any pipe work that contains or has contained flammable refrigerant shall use any sources of ignition in such a manner that it may lead to the risk of fire or explosion. All possible ignition sources, including cigarette smoking, should be kept sufficiently far away from the site of installation, repairing, removing and disposal, during which flammable refrigerant can possibly be released to the surrounding space. Prior to work taking place, the area around the equipment is to be surveyed to make sure that there are no flammable hazards or ignition risks. "No smoking" signs shall be displayed.

7. Ventilated area

Ensure that the area is in the open or that it is adequately ventilated before breaking into the system or conducting any hot work. A degree of ventilation shall continue during the period that the work is carried out. The ventilation should safely disperse any released refrigerant and preferably expel it externally into the atmosphere.

8. Checks to the refrigeration equipment

Where electrical components are being changed, they shall be fit for the purpose and to the correct specification. At all times the manufacturer's maintenance and service guidelines shall be followed. If in doubt consult the manufacturer's technical department for assistance. The following checks shall be applied to installations using flammable refrigerants:

- The charge size is in accordance with the room size within which the refrigerant containing parts are installed;
- The ventilation machinery and outlets are operating adequately and are not obstructed;
- If an indirect refrigerating circuit is being used, the secondary circuit shall be checked for the presence of refrigerant;
- Marking to the equipment continues to be visible and legible. Markings and signs that are illegible shall be corrected;
- Refrigeration pipe or components are installed in a position where they are unlikely to be exposed to any substance which may corrode refrigerant containing components, unless the components are constructed of materials which are inherently resistant to being corroded or are suitably protected against being so corroded.

9. Checks to electrical devices

Repair and maintenance to electrical components shall include initial safety checks and component inspection procedures if a fault exists that could compromise safety, then no electrical supply shall be connected to the circuit until it is satisfactorily dealt with. If the fault cannot be corrected immediately but it is necessary to continue operation, an adequate temporary solution shall be used. This shall be reported to the owner of the equipment so all parties are advised.

Initial safety checks shall include :

- That capacitors are discharged: this shall be done in a safe manner to avoid possibility of sparking;
- That there no live electrical components and wiring are exposed while charging, recovering or purging the system;
- That there is continuity of earth bonding.

TECHNICAL PARAMETERS

PORTABLE AIR CONDITIONER	
Cooling Capacity	15300BTU/4500W
Power Supply	220-240V~50Hz
Rated Power	2120W (35/24)
Rated Current	9.2A
Max Power	3000W (45/30)
Max Current	12.8A
Max Suction Pressure	2.5MPa
Max Discharge Pressure	4.5MPa
Refrigerant	R32/840g
Operating Temperature	18~45 °C
Net Weight	67kg
Product Size	520x480x1035 (mm)
Serial Number	1032T
	

ELECTRICAL SCHEMATIC DESIGN

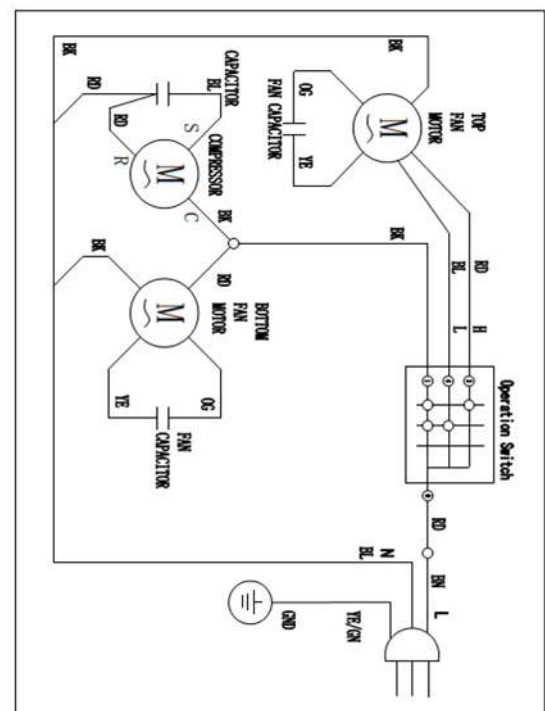

CONTENT

WARNING 2

CONTENT 7

STANDARD OPERATING PROCEDURE..... 8

OPERATION, PREVENTITIVE MAINTENANCE 9

TROUBLESHOOTING..... 12

PARTS DIAGRAM & PARTS LIST 13

PRODUCT INFORMATION TOP TIPS 14

WARRANTY 15

INTENDED USE

This appliance is intended for air conditioning industrial or trade workshop/office environments. It is not suitable for any other purpose (such as drying clothes, cooling food, etc.) This product is an Industrial Product and not suitable for household use.

STANDARD OPERATING PROCEDURE

DO NOT use this equipment unless you have been trained and assessed to a competent level in its safe use and operation, and have been given permission to use this



DO NOT tilt the unit



DO NOT operate the unit with wet or damp hands

PRE-OPERATIONAL SAFETY CHECKS

- Do not use this Portable industrial spot cooling Portable industrial spot cooling air conditioners in areas that use or store volatile substances (gasoline, kerosene, liquefied gas and other volatile liquids; magnesium, aluminium, lead and other volatile dust and/or vapours) to avoid possible ignition, explosion or fire.
- Servicing must be carried out by a qualified service technician. Use only TradeQuip identical replacement parts. Use of any other parts will void the warranty. Ensure the Portable industrial spot cooling Portable industrial spot cooling air conditioners is disconnected from power before servicing.
- Use the right product for the job. There are certain applications for which the Portable industrial spot cooling Portable industrial spot cooling air conditioners was designed. Do not modify the Portable industrial spot cooling Portable industrial spot cooling air conditioners and do not use the Portable industrial spot cooling Portable industrial spot cooling air conditioners for a purpose for which it was not intended.
- Always disconnect the Portable industrial spot cooling Portable industrial spot cooling air conditioners when moving it from one location to another.
- Transport and store the unit in an upright position only. Leave unit in an upright position for at least 3 hours before first use.
- Always place the unit on an even, level surface.
- Ensure the unit is connected to a grounded power supply of the correct rating / capacity.
- The unit will cool when the room temperature is between 18°C (64.4°F) ~ 45°C(113°F) depending on the thermostat setting.
- DO NOT use this unit for functions other than those described in this instruction manual.
- DO NOT tilt the unit. Only use in the upright position on an even, flat surface. Unit must be positioned at least 600mm from the nearest object in any direction
- Ensure 240V mains power supply.
- Use within temperature range of 18°C ~45°C
- This Portable industrial spot cooling Portable industrial spot cooling air conditioners is intended for indoor use only.
- DO NOT cover or obstruct the unit's inlet and outlet grills or ducting.
- DO NOT use the unit in areas where it will be exposed to rain or water.
- NEVER unplug the unit while it is operating.
- DO NOT place any foreign objects on the unit.
- DO NOT operate the unit with wet or damp hands.
- DO NOT allow chemical substances to come into contact with the unit.
- DO NOT operate the unit in the presence of flammable substances or vapours such as alcohols, pesticides, gasoline, etc. DO NOT use the plug to start and to stop the unit. Always use the control panel to start and to stop the unit.
- Always turn off the unit when it is not in use and unplug the power plug from the electrical outlet.
- Always turn the unit off and unplug the main power plug from the electrical outlet before cleaning, moving or performing maintenance.
- AVOID the use of adaptor plugs or extension cords. If it is necessary to use an extension cord or an adaptor plug to operate the unit, ensure that they are correctly rated for the application. Consult a local qualified electrician and all local electrical codes to ensure proper setup. Any extension cord used with this device must be rated for a minimum of 30A.
- DO NOT unplug the unit by pulling on the electrical cord. Keep electrical cord away from heat sources and always completely unroll the cord to avoid overheating. If the power cord becomes damaged, a qualified service agent, qualified electrician, or similarly qualified person must replace it, in order to avoid a hazard or shock.
- The filters must be used with the product at all times. When the filters are removed for cleaning, always ensure that the unit has been turned off and unplugged from the electrical outlet.
- DO NOT operate the unit with a damaged power cord or plug, after it malfunctions, has been dropped or damaged.
- Regularly clean the filters to maintain efficiency. If the filters are not cleaned regularly, the unit's output performance and efficiency will decline and energy consumption will increase.
- Stop operation immediately if abnormal noise or odour is noticed. Contact a local service centre.
- This appliance is not to be used by children or persons with reduced physical, sensory or mental capabilities, or lack of experience and knowledge, unless they have been given supervision or instruction.
- This appliance must be installed in accordance with state and/or national wiring regulations.
- If the power supply cord is damaged, it must be replaced by the manufacturer, its service agent or similarly qualified electrician in order to avoid a hazard.

OPERATION, PREVENTITIVE MAINTENANCE

1. FEATURES

TradeQuip Portable Industrial Portable industrial spot cooling Portable industrial spot cooling air conditioners are designed for economical spot cooling in workshops, service rooms, warehouses and offices especially where other electrical equipment creates a heat load. TradeQuip Portable Industrial Portable industrial spot cooling Portable industrial spot cooling air conditioners are completely self-contained and housed within an insulated cabinet. The unit's exterior is constructed of galvanized steel and protected with a tough powder-coated, polyester finish. All models are equipped standard with heavy-duty castors for easy portability. TradeQuip Portable Industrial Portable industrial spot cooling Portable industrial spot cooling air conditioners bring in air from an outside source to cool its condenser, cycling hot air to an outside source. This provides a fresh cool air room temperature with high efficiency. Just wheel it in, plug it in and it goes to work immediately, giving high cooling capacity to help wherever and at whatever point you require it.

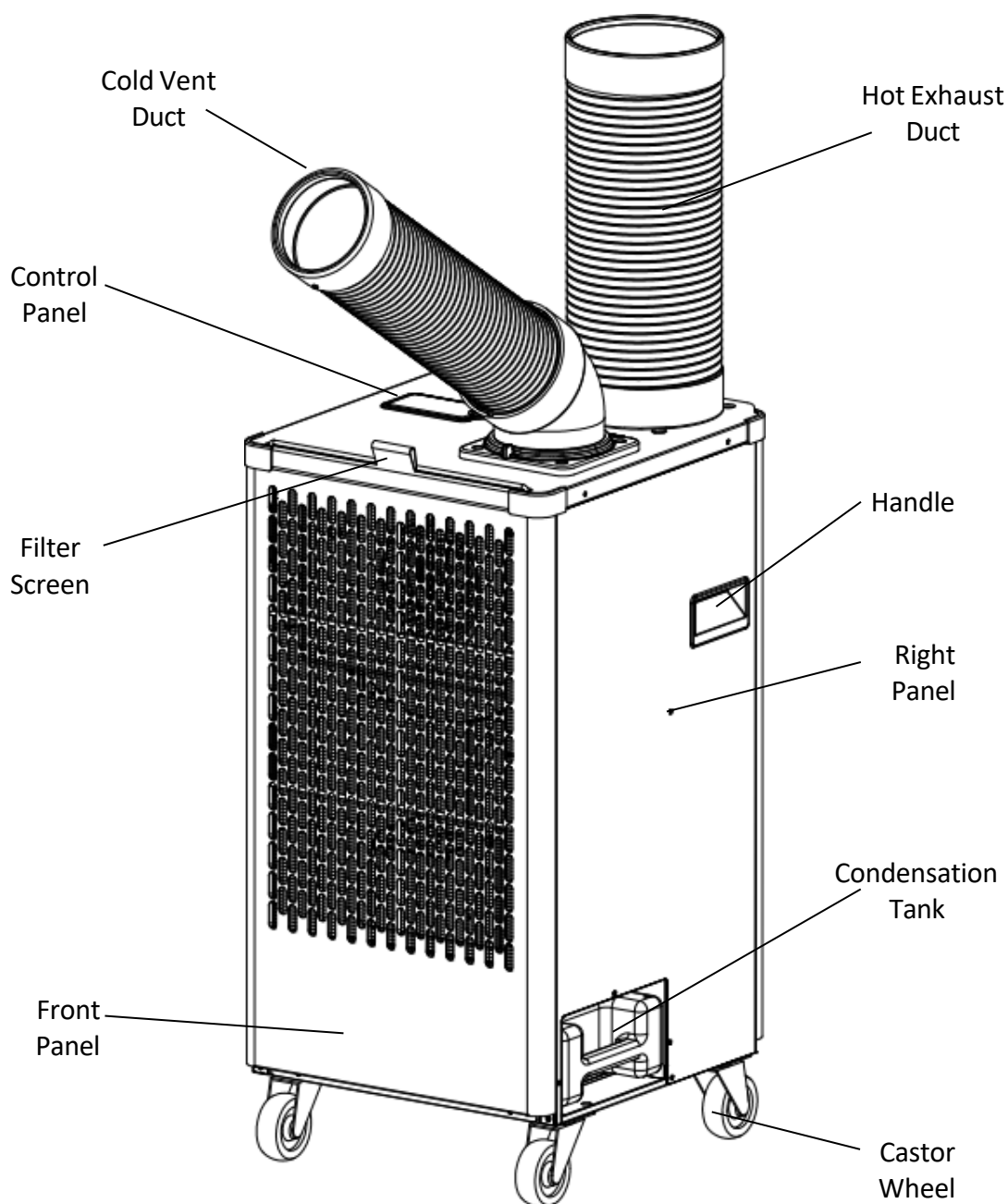

2. BEFORE USE

Prior to each use conduct a visual inspection by checking for abnormal conditions, such as cracked joins and damaged, loose, or missing parts. If the supply cord is damaged, it must be replaced by the manufacturer, service agent or similarly qualified persons in order to avoid a hazard.

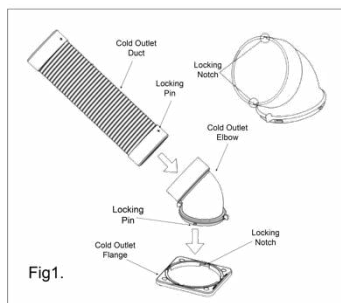

Installation of Elbow

Insert the elbow by aligning the notches in the detachable elbow base on the machine, insert and rotate anti clockwise until it locks into place (Fig1).

Installation of Cold Vent Duct



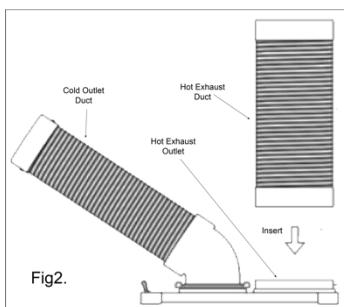

Insert the cold vent duct pipe by aligning the notches into the detachable elbow, insert and rotate left until it locks in place (Fig1).



Installation of Hot Exhaust Duct

Insert the hot exhaust duct pipe into the heat vent. Do not install it in place to guarantee stable and firm exhaust pipe (Fig.2).

3. OPERATION

1. Unlock the castors wheels and push the unit using the side handles to a flat, level surface and set the castor brakes to the locked position.
2. Check the prongs and surface of the power cord plug for dust/dirt. If dust and/or dirt are present, wipe off with a clean, dry cloth.
3. Check the power cord, plug and prongs for damage or excess play.
4. If any damage or excess play is found, contact a qualified repair technician or a qualified electrician to perform replacement or repair of the power cord, plug or prongs. Rotate the dial to  or  and the compressor immediately launches refrigeration.
5. Start the fan by rotating the control switch to Low  and/or increase the airflow by rotating to High .
6. When the dial is rotated to "0" the appliance is switched off.
7. When the appliance is running, ensure the filter screen and the cold air ducting are 300mm minimum from the wall or other obstacles, and the hot exhaust pipe is 900mm minimum from the ceiling or other obstacles.(Fig12)
8. Ensure the appliance is on a level, solid surface.
9. Ensure the filter screen and air outlets are clear of obstacles.
10. Ensure the hot air exhaust pipe is not pointing towards poor heat resistant items.



WARNING – Always turn the machine off before moving – Wait 3minutes before restarting the machine.

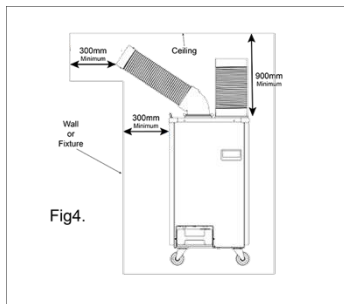

Minimum Clearance

When the appliance is running, ensure the filter screen and the cold air ducting are 300mm minimum from the wall or other obstacles, and the hot exhaust pipe is 900mm minimum from the ceiling or other obstacles.

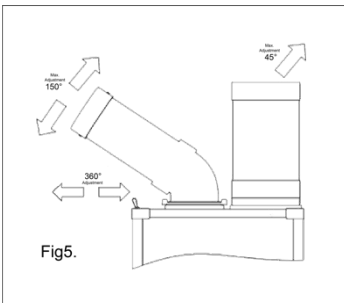

Adjustment Air Range

The cold air duct can rotate left or right to 360degrees (hot air exhaust duct is installed)

The cold air duct may be moved up or down to 150degrees

The range of adjustment angle for the hot air exhaust duct is 45degrees



WARNING -Adjust the cold air duct prior to use and adjust the air out direction of the hot exhaust duct later. When adjusting the flow angle of the cold air duct, grip the elbow for adjustment – do not hold on to the cold air duct directly.



Condensation Tank

A 5Litre polyethylene condensation tank in the lower-front compartment of the unit collects evaporator-coil condensation moisture. When full, simply remove, drain, replace, and restart. Do not move the machine if the condensation tank is full of water.

To empty the water in the condensation tank, ensure the end face on the tank handle is parallel. Rotate the control switch to 0. Empty the water in a resourceful manner and reinstall the condensation tank before restarting Portable industrial spot cooling Portable industrial spot cooling air conditioners.

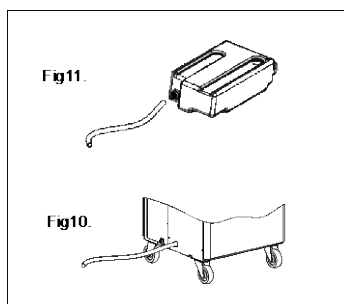

Pipe Drain (optional)

Condensation water may be discharged directly from the Portable industrial spot cooling Portable industrial spot cooling air conditioners drain pipe.

Remove the water tank and empty, push the optional drain pipe on to the appliance outlet inside the tank recess. Then locate the drain pipe through the round hole in the corresponding side plate. Ensure the end of the pipe is below the Portable industrial spot cooling Portable industrial spot cooling air conditioners.

Compressor Overload/Overheat Protection

The compressor overload protector will be activated to cut the power of the compressor to “Off” in the event of overly high or low voltage and/or overly high temperatures.

When the overload protector is activated, the machine will only blow non-refrigerated air.

Contact a qualified service technician if the overload protector is activated frequently.

4. MAINTENANCE

Disconnect power prior to any maintenance

Inspect the general condition of the Portable industrial spot cooling Portable industrial spot cooling air conditioners checking:

- for loose hardware
- cracked, bent, or broken parts, and
- any other condition that may affect the Portable industrial spot cooling Portable industrial spot cooling air conditioners safe operation

Filter Screen

Clean the filter screen regularly using a vacuum cleaner to remove dust and dirt. When required the filter screen can be cleaned with a cloth and lukewarm water. Do not use chemicals. Leave to dry in a shaded area before reinstalling.

NOTE: For effective cooling clean the filter at least every 2 weeks.

5. STORAGE

This Portable industrial spot cooling Portable industrial spot cooling air conditioners should always be stored in a dry location on a level surface in an upright position.

When you stop using this Portable industrial spot cooling Portable industrial spot cooling air conditioners, you should clean the filter and keep it in a dry place, be careful not to damage the Portable industrial spot cooling Portable industrial spot cooling air conditioners or filter.

Shut Down

Prior to shut down ensure the water in the condensation tank is empty. Always store the Portable industrial spot cooling Portable industrial spot cooling air conditioners in the upright position.

6. SERVICE & REPAIR

Any Portable industrial spot cooling Portable industrial spot cooling air conditioners found damaged in any way, or found to be worn or operates abnormally should be removed from service until repaired by an authorised service agent. Owners and / or operators should be aware that repair of this product may require specialised equipment and knowledge. Only authorised parts, labels and decals shall be used on this equipment. Annual inspection of the Portable industrial spot cooling Portable industrial spot cooling air conditioners is recommended and can be made by an authorised repair facility to ensure that your equipment is in optimum condition and that the equipment has the correct decals and safety labels specified by the manufacturer.

TROUBLESHOOTING

Problem	Cause	Solution
Out-of-Operation	<ul style="list-style-type: none"> • Power Cable loose • Fuse is burnt 	<ul style="list-style-type: none"> • Insert Power Cable into power supply • Repair or replace fuse
Out-of-Operation	<ul style="list-style-type: none"> • Heat exchange surface is blocked • Hot exhaust blower fails • External temperature is too high • Compressor capacitor is damaged • Refrigerating system pipeline is clogged • Overly high or low input voltage • Compressor overheat & overload protection fails • Compressor motor fails 	<ul style="list-style-type: none"> • Clean heat exchange surface • Repair or replace hot exhaust blower • Unplug the heater and relocate • Replace compressor capacitor • Replace pipeline system • Ensure correct voltage • Wait 3 minutes and then restart the heater • Repair or replace compressor
Water Leakage	<ul style="list-style-type: none"> • Drain pipe opening is clogged • Water tank position is not in place • Filter screen is dusty • Water tank is full 	<ul style="list-style-type: none"> • Clean drain pipe • Adjust water tank to the correct position • Clean filter screen • Empty water

PARTS DIAGRAM & PARTS LIST

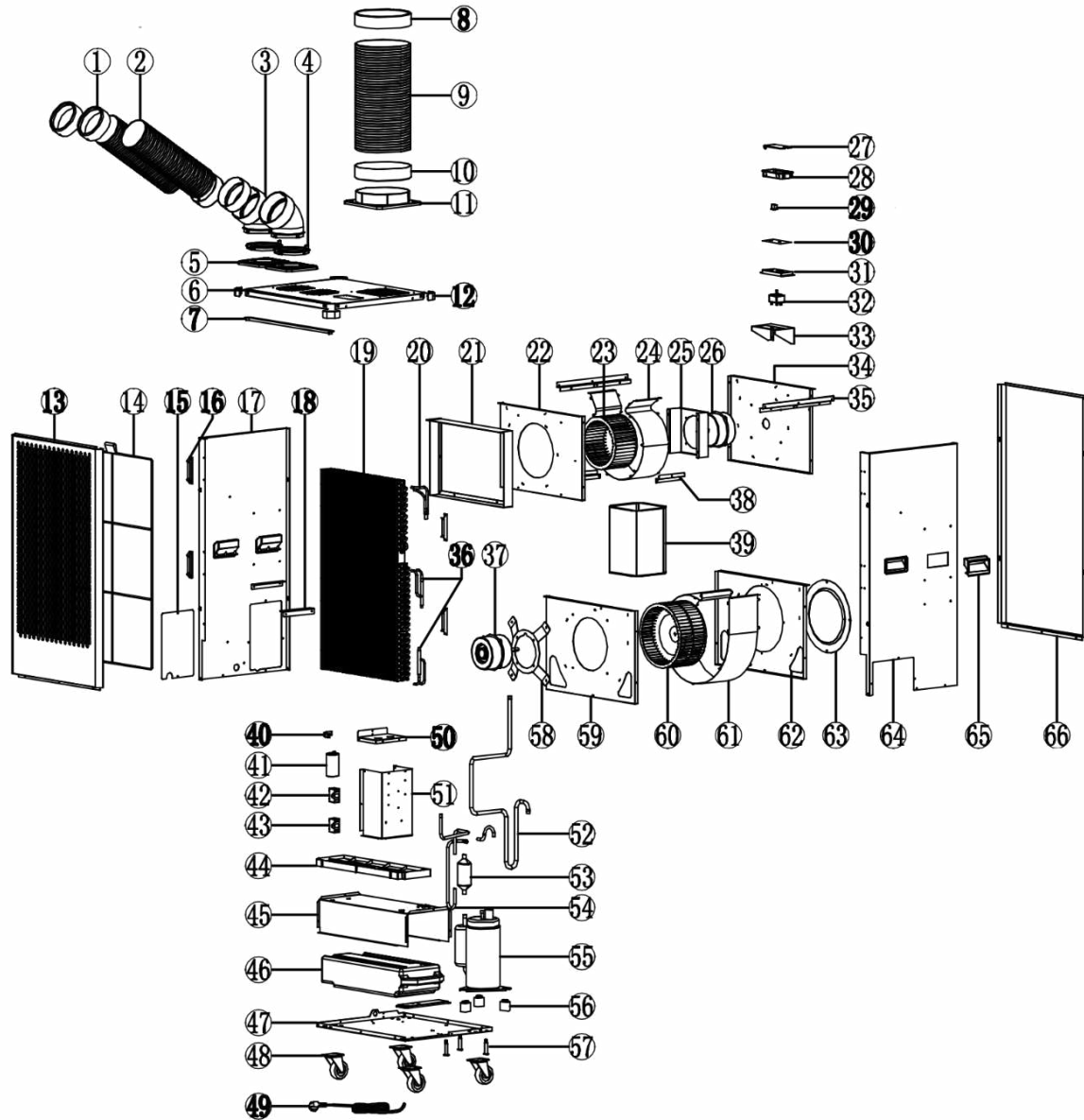

Part #	Description	QTY
1	Connector 1	6
2	Cooling Tube	3
3	Tube 1	3
4	Tube 1 Fix Frame	3
5	Tube 1 Fix Base	3
6	Top Cover	1
7	Top Cover Fix Plate	1
8	Tube Head	2
9	Tube 2	1
10	Tube Head	1
11	Hot Air Ring	1
12	Angle Protection	4
13	Front Shell	1
14	Filter Net	1
15	Control Cover Plate	1
16	Guide Groove	4
17	Left Side Plate	1
18	Side Plate Scaffold	2
19	Heat Exchanger Assy	1
20	Steaming Tube Assy	1
21	Anterior Spiral Case	1
22	Spiral Case Support	1

Part #	Description	QTY
23	Wind Mill 1	1
24	Cold Wind Spiral Case	1
25	Connect Bracket	1
26	Upper motor	1
27	Control Box Cover	1
28	Control Box Frame	1
29	Knob	1
30	Control Panel Label	1
31	Control Box	1
32	Rotate Switch	1
33	Switch Fix Plate	1
34	Spiral Case Bracket	1
35	Volute Connection Plate	5
36	Cold Inlet Pipe Assy	1
37	Lower Motor	1
38	Spiral Case Fixed Frame	2
39	Air Duct Components	1
40	Capacitor Bracket	1
41	Compressor Capacitor	1
42	Motor Capacitor 1	1
43	Motor Capacitor 2	1
44	Condensation Tray	1

Part #	Description	QTY
45	Tank Cover Plate	1
46	Condensation Tank	1
47	Chassis	1
48	Universal Castors	4
49	Power Cord & Plug	1
50	Control Box Cover	1
51	Control Box	1
52	Lower Pressure Tube	1
53	Muffler	1
54	High Pressure Tube	1
55	Compressor	1
56	Compressor Cushion	3
57	Pump Bolt	3
58	Hot Air Motor Support	1
59	Anterior Spiral Case	1
60	Wind Mill 2	1
61	Hot Air Volute shell	1
62	Posterior Spiral Case	1
63	Guide Plate	1
64	Right Side Plate	1
65	Handle	4
66	Back Shell	1

PRODUCT INFORMATION TOP TIPS

PRODUCT INFORMATION

How to extend the life of your Spot Cooling Air Conditioner

8 Top Tips

to extend the life of your TradeQuip Industrial Spot Cooling Air Conditioners

Includes Models:
1031T, 1032T,
1033T

- 1** Prior to any maintenance make sure the unit is switched off and unplugged from the mains electricity supply socket.

NOTE: The electricity supplies required per model are as follows.
1031T Runs on 240V 10A circuit
1032T Runs on 240V 15A circuit
1033T Runs on 240V 15A circuit



- 2** Emptying the Condensation Tank.

A 5 Litre polyethylene condensation tank in the lower-front compartment of the unit collects evaporator-coil condensation moisture.



When full, simply remove and drain.

- 3** During high humidity conditions the condensation tank will need to be emptied more frequently.

To alleviate this the Condensation Tank also comes with an optional Drain Pipe which can be installed. For information on installation instructions consult your owner's manual or at www.tqbbrands.com.au



- 4** Clean the filter screen regularly using a vacuum cleaner to remove dust and dirt.

When required the filter screen can be cleaned with a cloth and luke warm water. Do not use chemicals. Leave to dry in a shaded area before reinstalling.

NOTE: For effective cooling clean the filter at least every 2 weeks.



- 5** Lubricate the castor axles and ball race to ensure smooth movement when positioning your TradeQuip Spot Cooling Air Conditioner.



- 6** Correct positioning of your TradeQuip Spot Cooling Air Conditioner is crucial to providing adequate ventilation to prevent overheating and or restricted air flow.

When the appliance is running, ensure the filter screen and the cold air ducting are 300mm minimum from the wall or other obstacles, and the hot exhaust pipe is 900mm minimum from the ceiling or other obstacles.

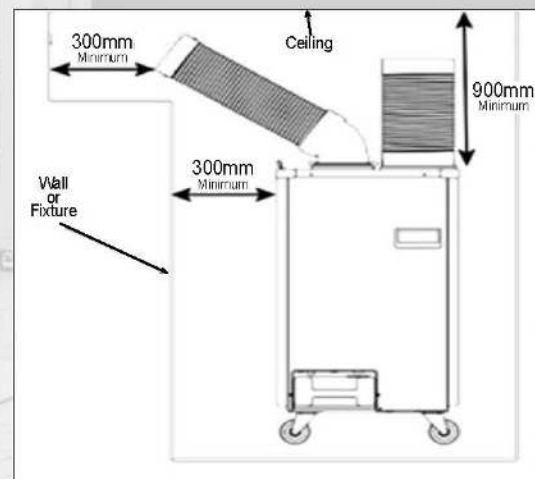

- 7** Always turn the machine off before moving it. If only moved over a very short distance ie within workshop, wait 3 minutes before restarting the machine. If transported for an extended period of time, or after first set up, allow 3 hours for the unit to settle prior to use.

- 8** Read the user Manual thoroughly and keep a copy easily accessible or visit our webpage www.tqbbrands.com.au for instructional documents & pre-start videos.

WARRANTY

TradeQuip products have been carefully tested and inspected before shipment and are guaranteed to be free from defective materials and workmanship for a period of 12 months from the date of purchase except where tools are hired out when the guarantee period is ninety days from the date of purchase.

Should this piece of equipment develop any fault, please return the complete tool to your nearest authorised warranty repair agent or contact TQB Brands Pty Ltd Warranty team – warranty@tqbbrands.com.au.

If upon inspection it is found that the fault occurring is due to defective materials or workmanship, repairs will be carried out free of charge. This guarantee does not apply to normal wear and tear, nor does it cover any damage caused by misuse, careless or unsafe handling, alterations, accident, or repairs attempted or made by any personnel other than the authorised TQB Brands Pty Ltd repair agent.

This guarantee applies in lieu of any other guarantee expressed or implied and variations of its terms are not authorised.

Your TQB Brands Pty Ltd guarantee is not effective unless you can produce upon request a dated receipt or invoice to verify your proof of purchase within the 12month period.

Consumer Guarantee

Our goods come with a guarantee that cannot be excluded under the Australian Consumer Law. You are entitled to a replacement or refund for a major failure and compensation for any other reasonably foreseeable loss or damage. You are also entitled to have the goods repaired or replaced if the goods fail to be of acceptable quality and the failure does not amount to a major failure.



All images and illustrations shown are for reference purposes only. All information, specifications and illustrations in this manual are based on the latest information available at the time of publication and are subject to change without notice. The information in this manual is periodically revised to ensure the latest information is included. Download the latest version of this manual and other related technical documentation from www.tqbbrands.com.au