

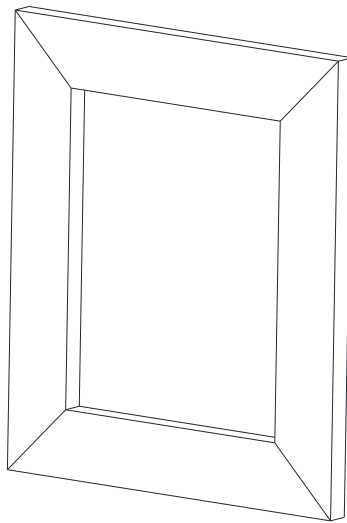

OWNER'S MANUAL



BARNWOOD MIRROR

Model # 20x27MIR-NAT (Natural) / 20x27MIR-WW (White)

Important / Important / Importante

FOR 3D ASSEMBLY INSTRUCTIONS
POUR DES DIRECTIVES D'ASSEMBLAGE 3D
PARA INSTRUCCIONES DE ENSAMBLAJE EN 3D



BILT.[®]

Intelligent Instructions
Directives intelligentes
Instrucciones Inteligentes



PARTS LIST

Your Barnwood Mirror should include the following parts. Please inspect box contents to ensure you have received all components.

If you are missing any parts, need assistance with assembly or have questions, please contact TRINITY Customer Service: 800.985.5506 or customerservice@trinityii.com. Parts can also be requested online via "Contact Us" section at www.trinityii.com.

You will need pencil, level, drill, 1/4-inch bit and Phillips bit for assembly. These are NOT included.

A

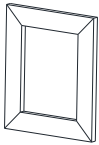

MIRROR
(1)

B



SCREW
(2)

C



DRYWALL ANCHOR
(2)

ASSEMBLY INSTALLATION

STEP 1

Place MIRROR (A) against wall. With a pencil, mark top of mirror at your desired mirror height.

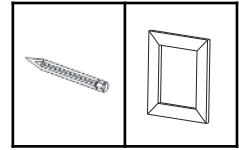

Pencil

A (1)

Note: Mounting screw height will be 1-inch lower than desired mirror height.

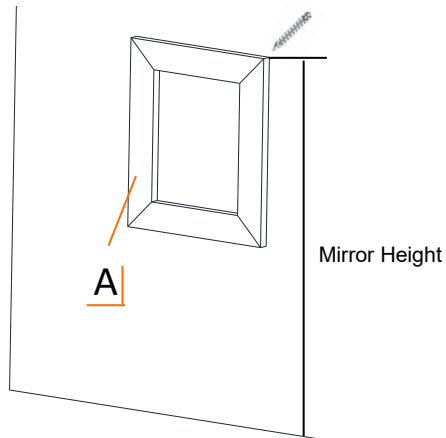

STEP 2

Position level 1-inch lower than desired mirror height marked in STEP 1. Using a pencil, mark a leveled horizontal line for mounting screw height.

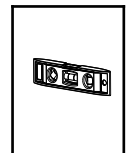

Level

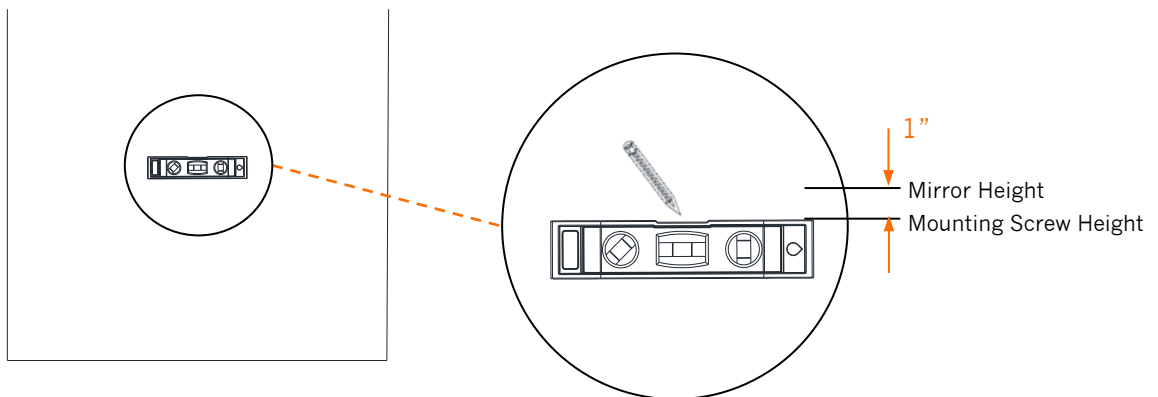

ASSEMBLY INSTALLATION

STEP 3

On mounting screw height line from STEP 2, mark 2 points 16-inch apart corresponding to the spacing of keyholes at back of mirror.



Pencil

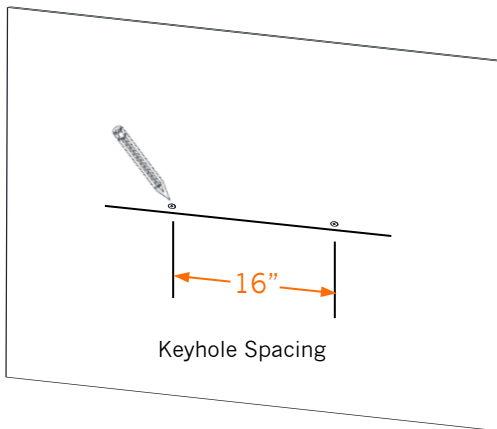

Keyhole Spacing

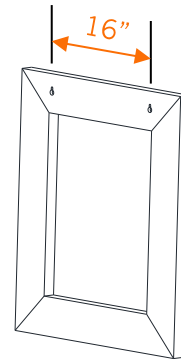

STEP 4

Using 1/4-inch Drill Bit, drill 2 pilot holes into wall through marked points.

Screw (2) DRYWALL ANCHORS (C) into pilot holes with Phillips Bit until they are flush with wall.

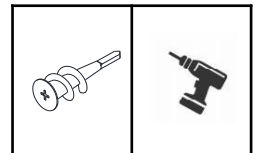

C (2)

Drill

Note: If mounting onto a surface other than drywall, you may need to purchase specialty screws and anchors for that type of surface. If unsure, please consult a local professional for proper tools and hardware needed.

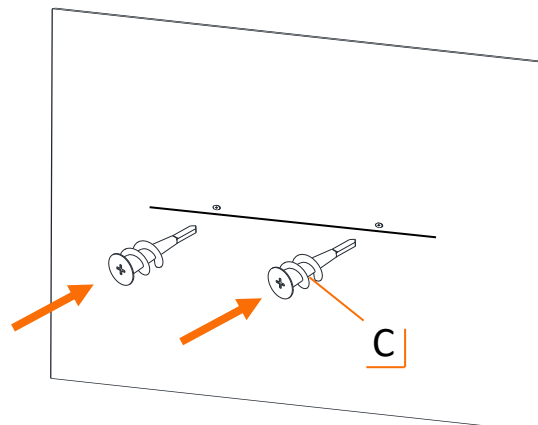

ASSEMBLY INSTALLATION

STEP 5

Insert SCREW (B) into DRYWALL ANCHOR (C) using Drill with Phillips Bit. Leave screw head 1/4" exposed so there is room to hang the mirror on the screws.

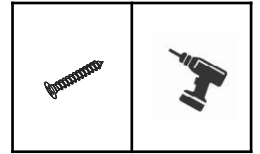

B (2)

Drill

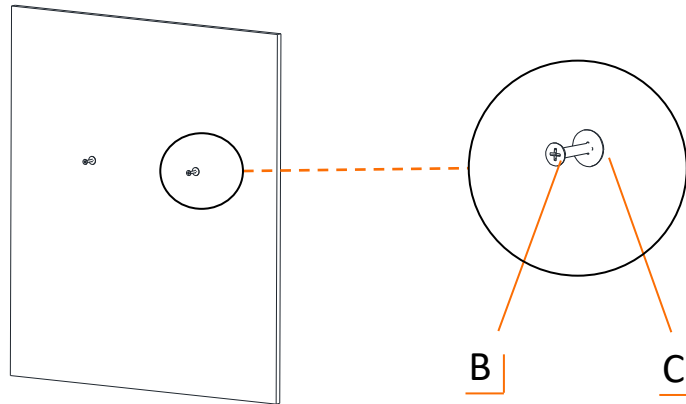

STEP 6

Slide MIRROR (A) over screws until they insert into keyholes. Lower MIRROR (A) onto screws until it locks into place.

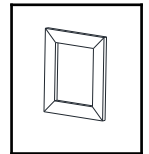

A (1)

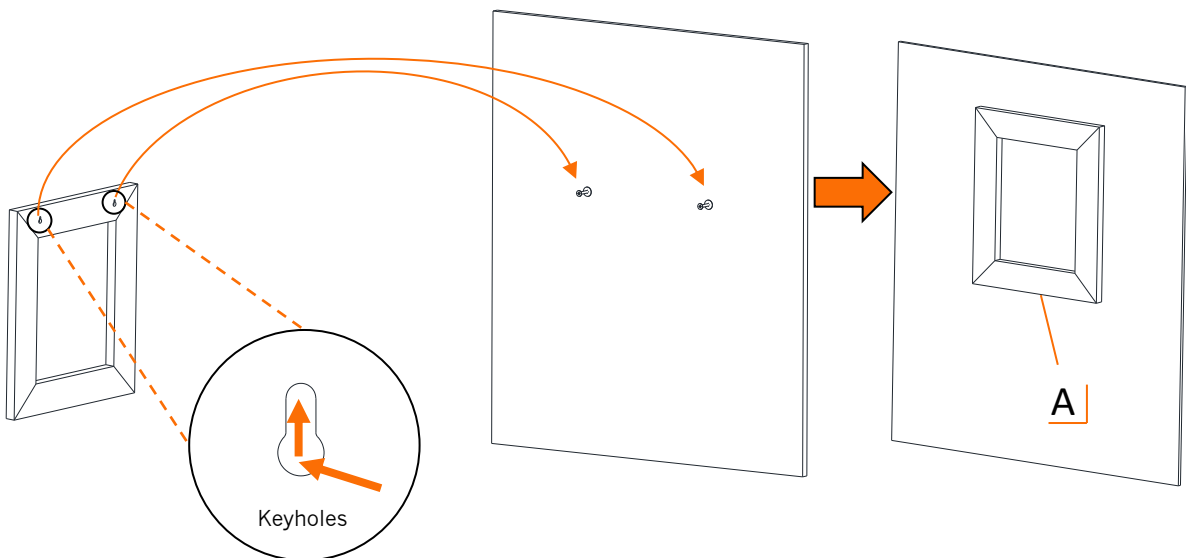

WARNINGS

1. **Read and understand all instructions.** Failure to follow all instructions may result in injury and/or damage.
2. **The warnings, cautions, and instructions discussed in this manual cannot cover all possible conditions or situations that may occur.** The user must always be aware of their environment and ensure that they use the product in a safe and responsible manner.
3. **Do NOT modify the product in any way.** Unauthorized modification may impair the function and/or safety of the product and may affect the life of the product. Any modifications will void warranty.
4. **Check for damaged parts.** Before using this product, carefully check that all parts are in good condition, and that the product will operate properly and perform its intended function. Replace damaged or worn parts and never use this product with a damaged part.
5. **Do NOT overload the product.**

CARE AND MAINTENANCE

- Avoid harsh, abrasive cleaners, and other corrosive chemicals.
- Do not use scouring pad for cleaning.
- Clean with damp cloth and/or mild dish soap.
- Dry completely with dry sponge or cloth.

1 YEAR LIMITED WARRANTY

BARNWOOD MIRROR Model # 20x27MIR-NAT/ 20x27MIR-WW

Trinity International Industries (“Trinity”) warrants to the original consumer purchaser (“Purchaser”) that Trinity’s products (each a “Product”) shall be free from defects in workmanship and materials for a period of one (1) year from the date of original purchase. Trinity’s obligation under this warranty shall be limited to repair or replacement of, or adequate compensation for the Product which shall not be greater than the amount of the purchase price of the Product, at the option of Trinity, during the warranty period. Repair or replacement of the Product will be performed within a reasonable time after notice of the defect has been provided to Trinity by the Purchaser. All replaced parts and Products become the property of Trinity and must be returned to Trinity.

This warranty excludes normal wear and tear of the Product and its parts or components, and damage arising from any of the following: negligent use or misuse of the Product, use contrary to this User’s Manual, or alteration by anyone other than Trinity. The warranty period of one (1) year shall not be extended or renewed by the repair or replacement of, or compensation for, the Product. Any warranty implied by applicable law is limited in duration to one year from the date of purchase and is subject to the same conditions and limitations as is provided for our express warranty.

No warranty or guarantee given by any person, firm, or corporation other than Trinity with respect to the Product shall be binding on Trinity.

If your Product is defective or otherwise requires service or parts, please call Trinity Customer Service toll-free at (800) 985-5506, between 5:00 a.m. and 5:00 p.m. PST. Please tell us which model you purchased, the date of the purchase, and the problem with your Product. A copy of your original purchase receipt must accompany your service request.

LIMITATION OF REMEDIES AND LIABILITY

Trinity (and its employees, officers, members, managers, affiliates and assigns) shall not be liable for any incidental, consequential, special, indirect, remote, special or punitive damages for breach of any warranty, express or implied, including, but not limited to, lost profits, lost savings, loss of anticipated benefits and attorneys’ fees, which arise out of the purchase, use or inability to use the Product, whether arising out of contract, negligence, strict tort, product liability, or any other legal theory on which a claim is based. As noted above, to the extent damages are allowed by our express warranty or by applicable law, those damages may not exceed the purchase price paid for the Product. Without limiting the foregoing, Purchaser assumes all risk and liability for loss, damage, or injury to Purchaser and Purchaser’s property and to others and their property arising out of the use, misuse, or inability to use the Product. This limited warranty shall not extend to anyone other than the original purchaser of the Product, is nontransferable, and states your exclusive remedy.

Some States do not allow limitations on how long an implied warranty lasts, so the above limitation may not apply to you. Some States do not allow the exclusion or limitation of incidental, consequential, special, or punitive damages, so the above limitation or exclusion may not apply to you. This warranty gives you specific legal rights, and you may have other rights which vary from State to State.

PRODUCT REGISTRATION

Thank you for purchasing our product. To receive streamlined customer service, please register your product online at trinityii.com/pages/product-registration

CONTACT US

**QUESTIONS? NEED PARTS?
WE ARE HERE TO HELP!**

Please feel free to contact us. There are no questions too small, or any problems too big. We're committed to providing our customers with the highest level of service.

TRINITY Customer Service

TEL: 800.985.5506

FAX: 310.347.4134

EMAIL: customerservice@trinityii.com

**Monday through Friday
5:00 AM – 5:00 PM (PST)**

www.trinityii.com