

## Chapter 04 Connecting

To get a more stable and better experience, please connect a 45W or higher power supply first. It is recommended to use our original power adapter.

### TYPE-C Connection

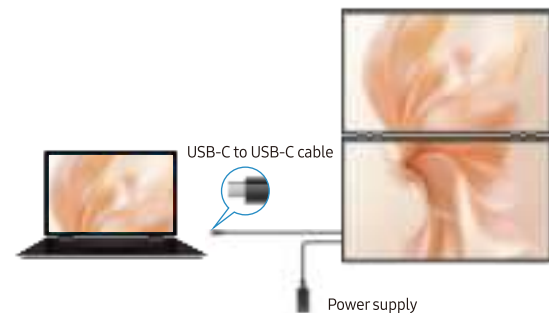

### HDMI Connection

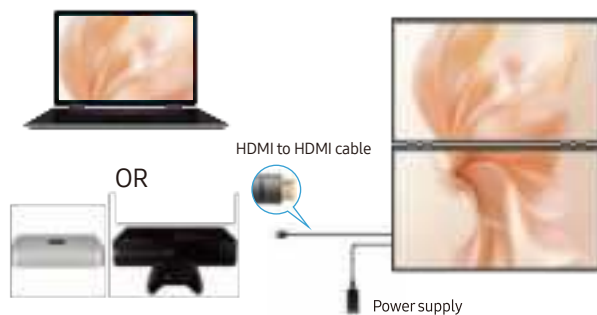

## Chapter 05 Display Mode

### Duplicate Mode

In the laptop's display settings, select "Duplicate", the monitor will display the same content as the laptop.

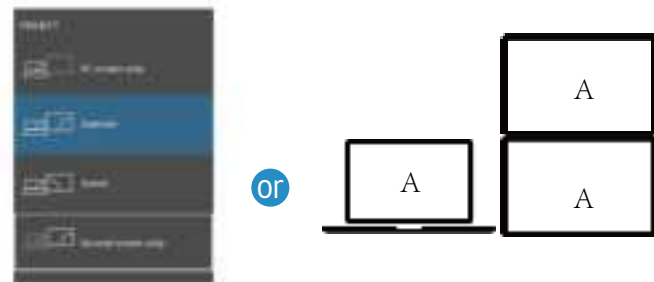

### Extend Mode

In the display settings of the laptop, select "Extend", the monitor can display different content from the laptop.

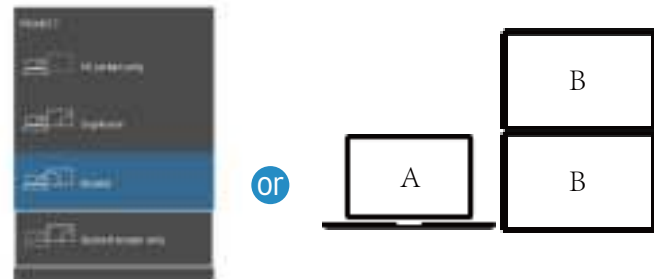

### Link Mode

Use the **Sixth button**  on the right side of the monitor to turn the link mode on or off. For the best experience, set your laptop to **Extend Mode**. This way, the monitor's two screens will combine into a single display with a resolution of **1920x2160**. If your laptop is set to Duplicate Mode, the monitor will only show a 1920x1080 resolution, with black bars appearing at the top and bottom of the screen. To fix this, simply check your display settings and switch to **Extend Mode**.

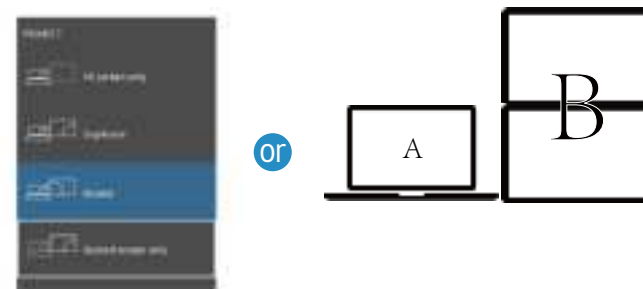

## Chapter 06 Q&A

### Important Tips:

If you find any issues with your monitor, please contact us at [help@uperfect.com](mailto:help@uperfect.com) before returning it. We will help you solve your problems and try our best to make you satisfied. We take full responsibility for our products. If there are any defects that cannot be solved, we will refund or send you a replacement.

### Q: Why does my monitor not turn on?

1. Make sure the cable you use is provided by us, or is compatible with your device and is not damaged.
2. Select the correct input source, such as HDMI, Type-C.
3. If you are using a Type-C signal source, please ensure that the Type-C port of your devices support both power and signal transmission; and make sure that the cable is connected to the monitor's second Type-C port, not the first.
4. This may be caused by insufficient power supply. It is recommended to use an external power supply above PD45w.

### Q: The screen flickers or goes black during use.

1. It is generally caused by an insufficient power supply. The monitor require high power support. Please use the original cable included to power the monitor.
2. If you use a power bank to power the monitor, please confirm whether the power of the power bank reaches 45W or above. In addition, if you need a power bank, please contact us at [support@uperfectmonitor.com](mailto:support@uperfectmonitor.com).
3. If there is external interference, please try to move speakers and other equipment away;
4. Please try to set the device refresh rate to 60Hz;
5. Cable is defective or damaged.

### Q: It says "no signal", what to do?

1. When connecting with a USB-C cable, make sure your device supports USB3.1/Thunderbolt 3. please add a Mini HDMI to HDMI cable for signal transmission.
2. Please make sure to use the original cables.
3. Please try another device. If it still fails, please tell us for a replacement.

Q: Touch operation on the monitor, but applied to the computer.

## 23.8" 100HZ Portable Monitor w/Stand User Manual



In order to ensure your safe use of this product, please read this manual carefully before using this product and keep it properly.

Email: [help@uperfect.com](mailto:help@uperfect.com)

## Chapter 01 Preparations

### Checking the Package Contents

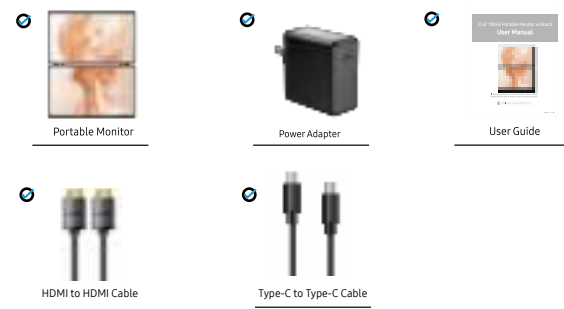

#### Note:

- If any of the above items is damaged or missing, please contact us immediately. ([help@uperfect.com](mailto:help@uperfect.com))
- The appearance of the components may differ from the images shown.

### 1.The Stand supports 180°opening up

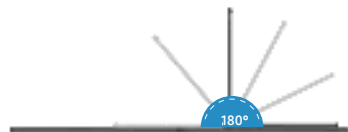

### 2.Dual screen supports 0-315° folding

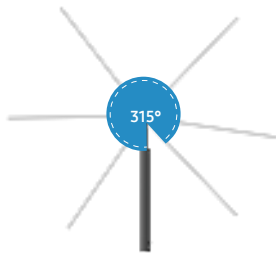

## Interface Function Introduction

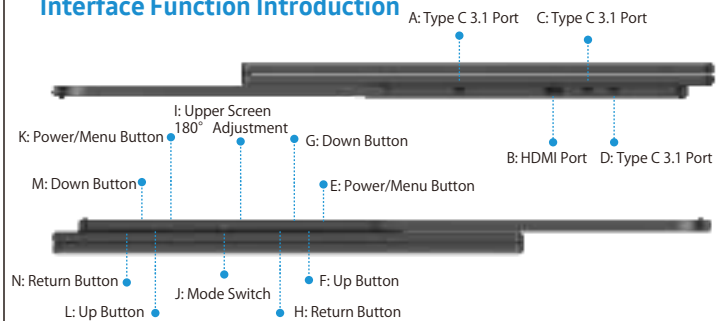

### A&C&D: USB Type-C Port

For power and signal transmission.

### B: HDMI Port

For signal transmission.

### E&K: Power&Menu Button

Short press to enter the menu, long press to turn on/off.

### F&L: Up Button

Quick enter the brightness adjustment interface, continue to increase brightness. On the menu page, you can scroll forward or upward.

### G&M

Quick enter the volume adjustment interface, continue to decrease volume. On the menu page, you can scroll backward or downward.

### H&N: Return

Step back through the previous menu until you return to the desktop.

### I: Screen Orientation Switching

180° orientation switching on the upper screen.

### J: Mode Switching

Press to switch extend mode, duplicate mode, link mode.

## Chapter 02 Specifications

Color	Black
Model	M238J11
Resolution	1920*1080
Aspect Ratio	16:9
Brightness	300 cd/m <sup>2</sup>
Color Gamut	120% sRGB
Display Color	16.7M(8bit)
VESA	100*100@M4*5mm
Interfaces	HDMI Prot
	Type C 3.1 Port * 3
Panel Type	IPS
Refresh Rate	100HZ
Contrast Ratio	1000:1

## Chapter 03 Screen Adjustment

### On-Screen Display Menu Introduction

#### PICTURE



#### Color Settings



#### Audio



#### Other



#### LowPowerMode

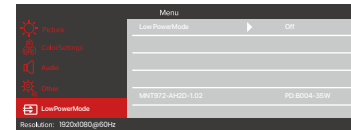

## Chapter 07 Service Support

### Dear Customer,

Thank you for purchasing the Portable USB Monitor! We offer 100% money back guarantee in 30 days and 90 days replacement, 12 month warranty for any issue, professional tech support to ensure no-worry service.

Any query or problem, please contact us via

[help@uperfect.com](mailto:help@uperfect.com)

