

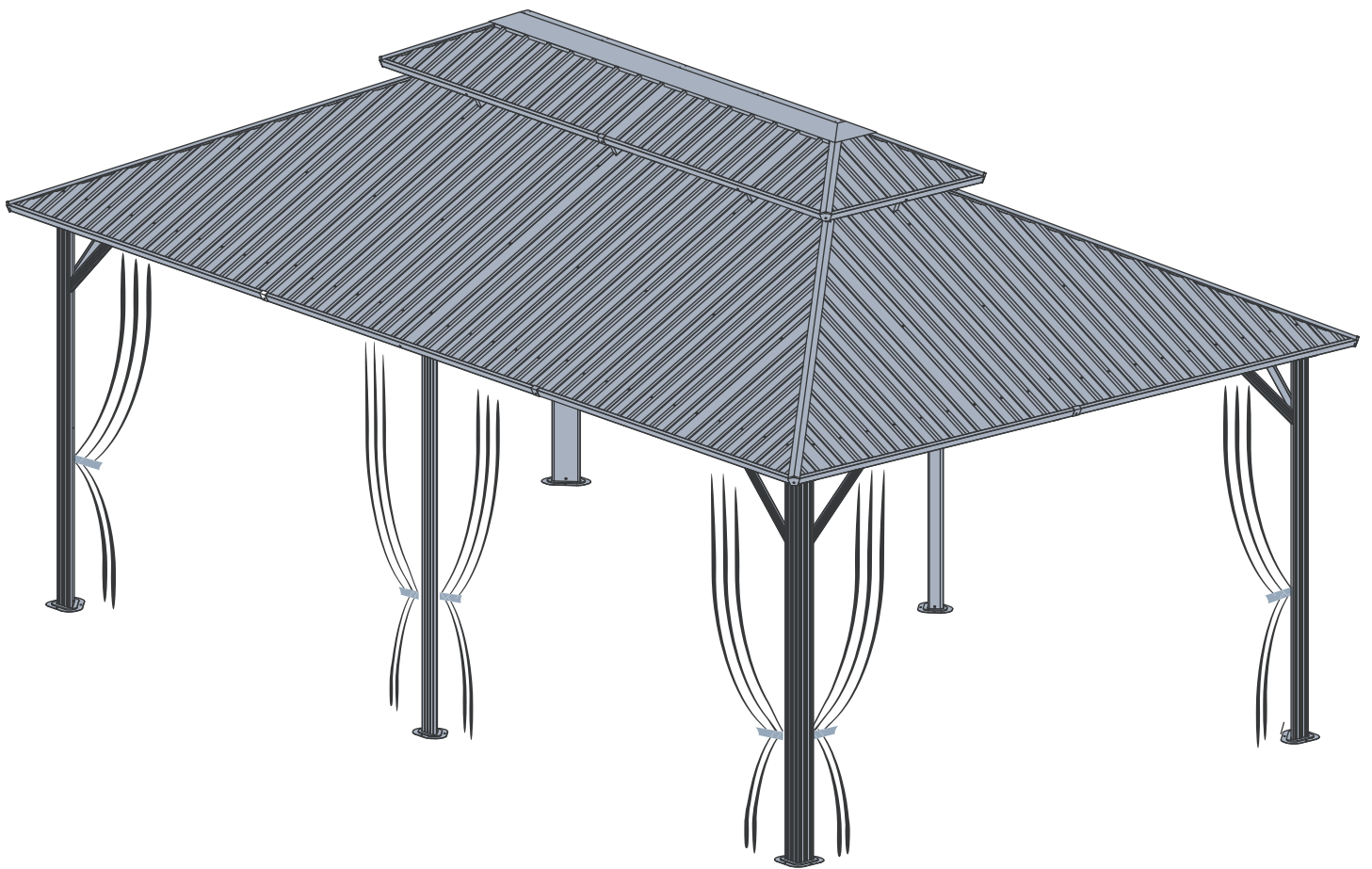

VEIKOUS



www.veikous.com



customerservice@veikous.com

STOP

**MISSING A PART?
CALL US BEFORE GOING
BACK TO THE STORE**

The store where you made your purchase
Does not stock parts for this item.

If you have assembly questions or you are missing or
have damaged parts, please call

1-858-324-1911

(Mon - Sun, 10:00 am to 7:00 pm EST)

you can also e-mail customerservice@veikous.com

or visit www.veikous.com

Please prefer email contact. Due to busy lines,
there may be a wait for calls to be answered.

**Please have the following information ready when you contact us,
so we can assist you promptly.**

- Order number or PO number (you can find the info on your invoice, receipt or platform account).
- The model number of the product (printed on the package box).
- Description of the part from the parts list.

-
- Read entire assembly manual, paying special attention to the important tips and safety information .
 - Ensure there are no missing pieces by first separating and identifying all parts.
 - Make sure to check packing material for small parts that may have fallen out during shipment.
 - Structures are not intended for public use. The Company does not warranty any of its residential structures subjected to commercial use such as: Daycare, Preschool, Nursery School, Recreational Park, or any similar Commercial Application.
 - This manual contains helpful information concerning assembly preparation, installation procedure and required maintenance.
 - Always keep safety in mind as your structure is being built.
 - Keep these instructions for future reference.

I TOOLS REQUIRED

EQUIPMENT REQUIREED(Not included in boxes)

**NOTE:Tools / equip ment are not shown to actual size and scale.*

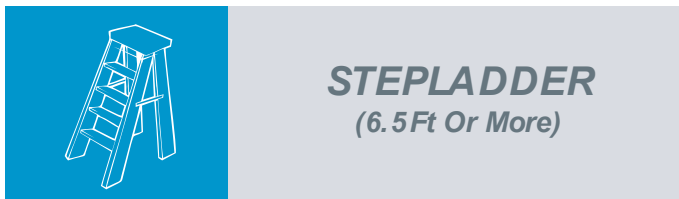
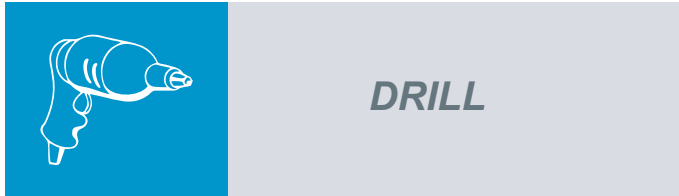

Matters needing attention

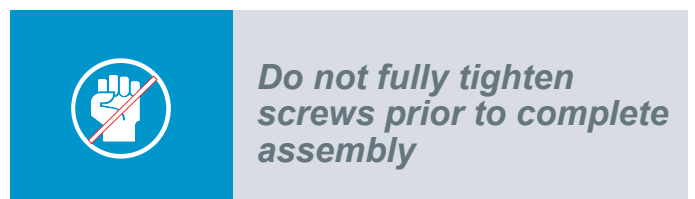
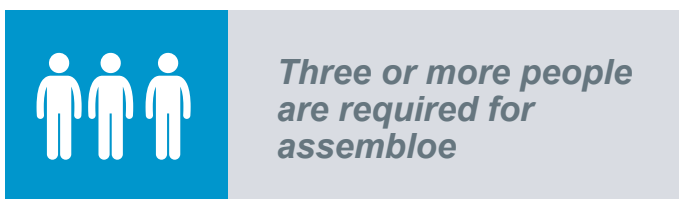

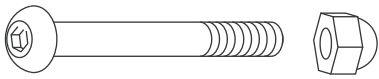

M6x47mm

S x 20+2



A x 4

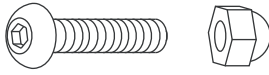

M6x23mm

T x 96+9



A1 x 2

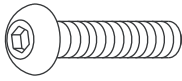

M6x23mm

U x 10+2



B x 2

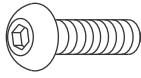

M6x15mm

V x 210+10



B1 x 2

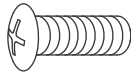

M4x12mm

V1 x 16+2



C x 2

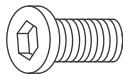

M6x12mm

V2 x 8+2



C1 x 2

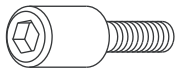

M6x10(D10x20)mm

X x 32+3



C2 x 2

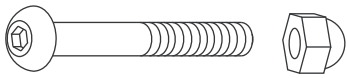

M6x42mm

X1 x 12+2

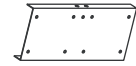

P x 6



M6x10(D10X38.5)mm

X2 x 8+1



E x 4

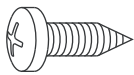

ST4.8x12mm

Y x 34+4



E1 x 4



D x 8

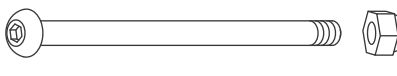

M6x85mm

S2 x 4+2



E3 x 2

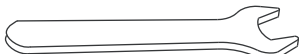

W2 x 1



F x 4

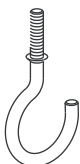

Wa x 5



Z x 1



F1 x 4

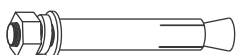





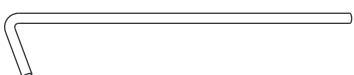



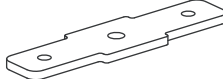

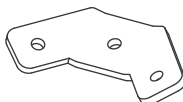

















M6x60mm

Z1 x 18

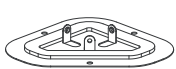

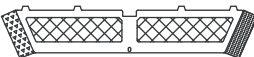
Z2 x 18

	G1 x 2		M3 x 8
	G2 x 2		M4 x 4
	G3 x 2		M5 x136+4
	G4 x 2		M6 x 8
	G5 x 2		M7 x 2
	H x 4		Q x 56+3
	G x 4		D4 x 8
	I x 4		R1 x 2
	J x 2		R2 x 2
	J3 x 2		R3 x 2
	J4 x 2		J1 x 4
	K x 1		J2 x 6
	K1 x 1		R x 76
	L x 4		D1 x 12
	M1 x 8		ZS3 x 2
	M2 x 12		ZS4 x 2

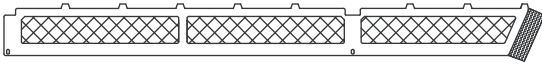

ZS5 x 2

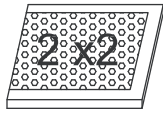
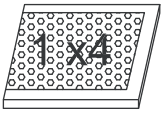

NET x 6

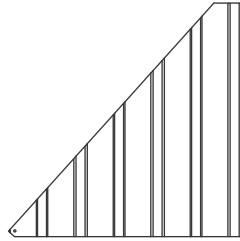

P0 x 2

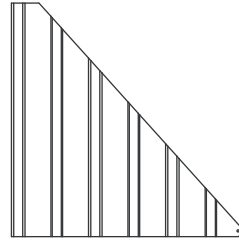

P1 x 2



P2 x 2

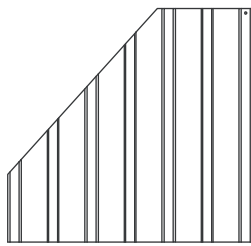

P3 x 2

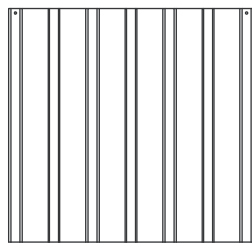

P4 x 8

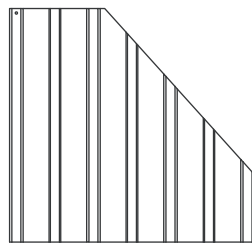

P5 x 2



P6 x 2



O1 x 2



O2 x 2

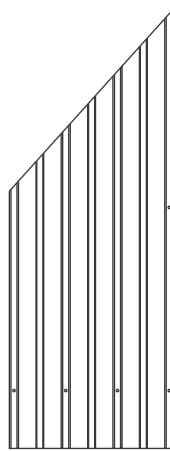

O3 x 2

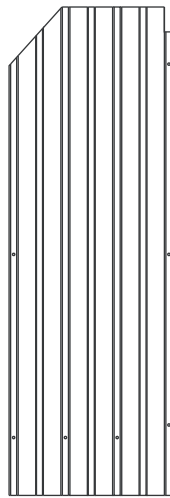

O4 x 2

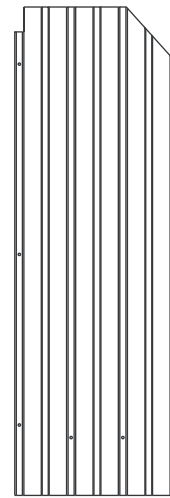

O5 x 2

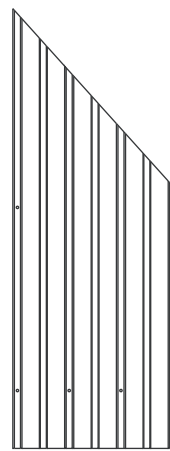

O6 x 2

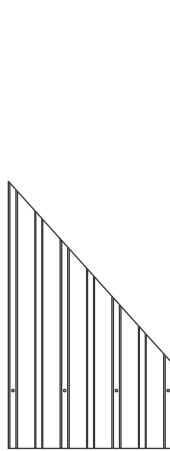

O7 x 2



O8 x 2



N1 x 2



N2 x 2

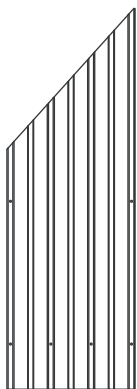

N3 x 2

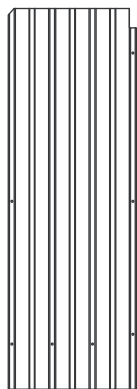

N4 x 2

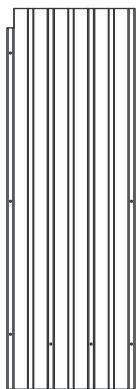

N5 x 4

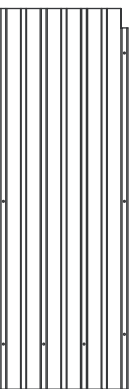

N6 x 4

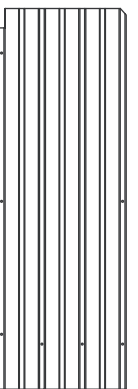

N7 x 2

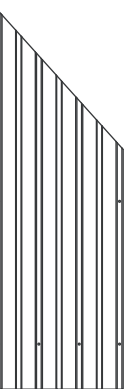

N8 x 2

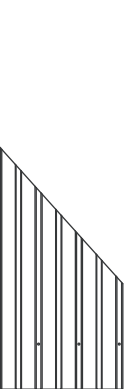

N9 x 2



N10 x 2

1



A x 4



L x 4

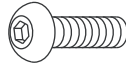

V x 12

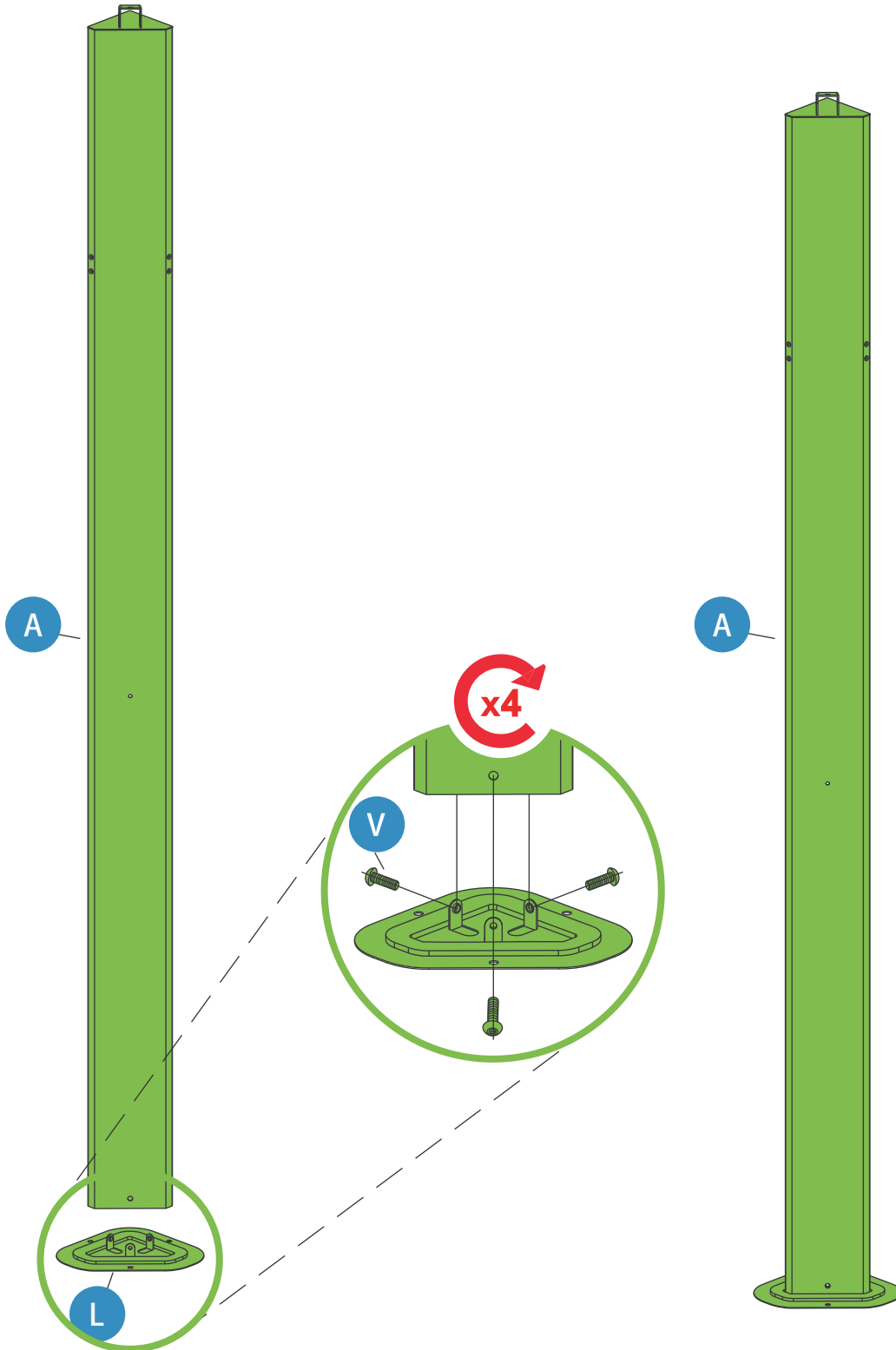

Attach part "L" to the bottom of part "A" and secure it with 3 screws "V".
Note: Repeat the above steps to connect the remaining sections.

2

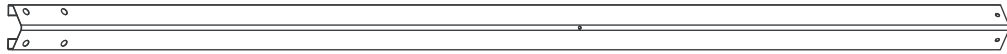

A1 x 2

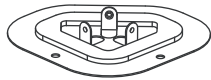

M7 x 2

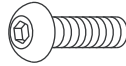

V x 6

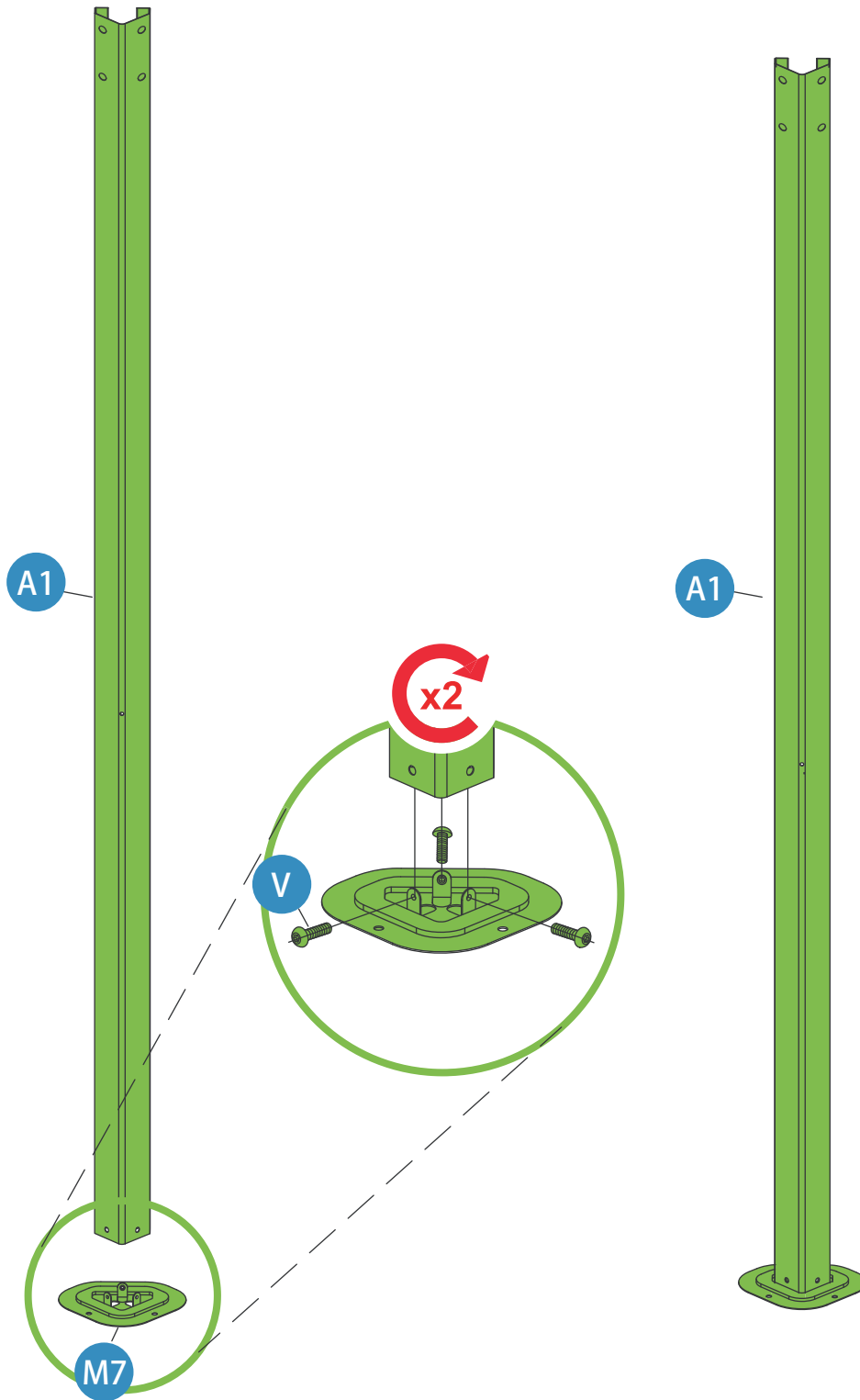

Attach part "M7" to the bottom of part "A1" and secure it with 3 screws "V".
Note: Repeat the above steps to connect the remaining sections.



Q x 56

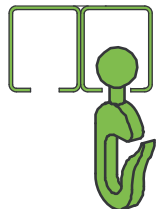
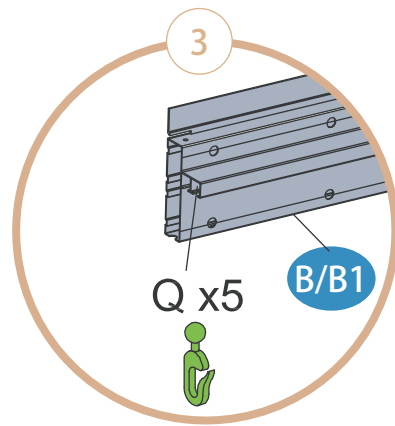
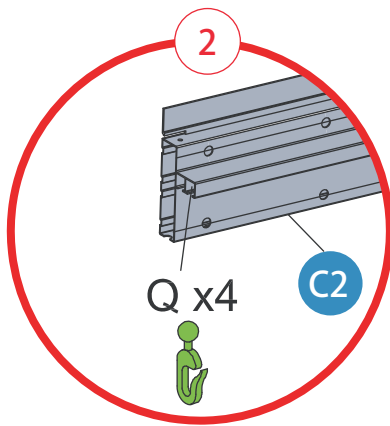
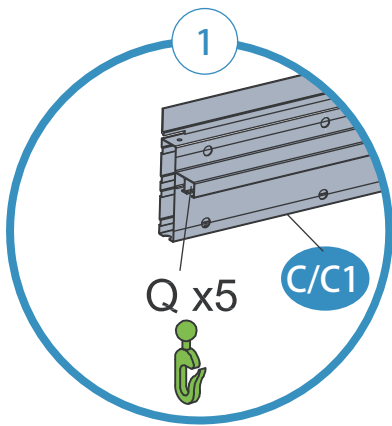
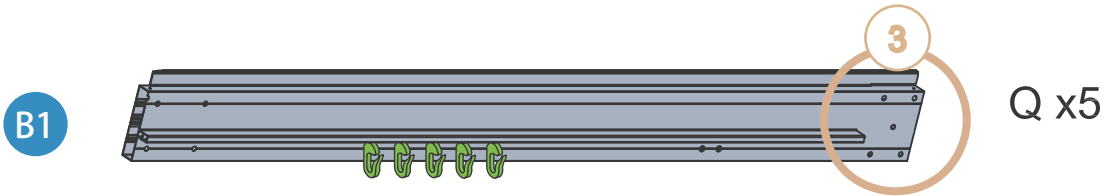
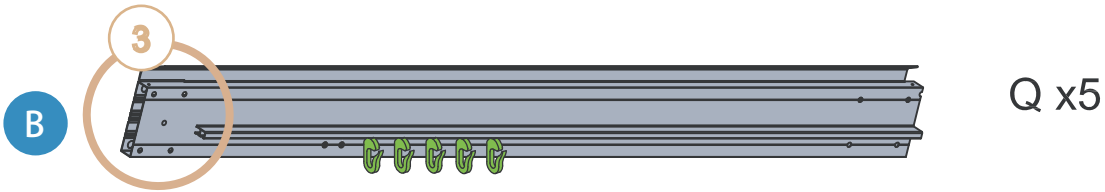
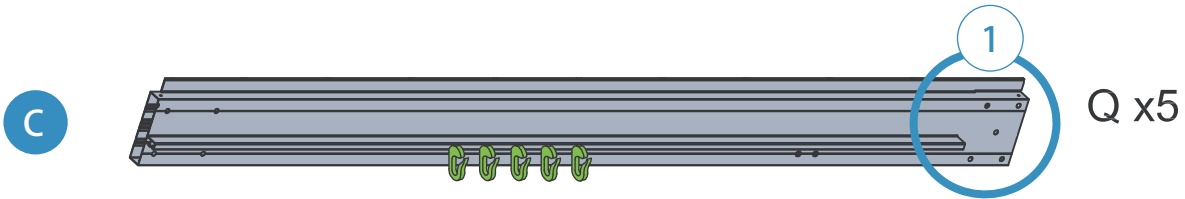
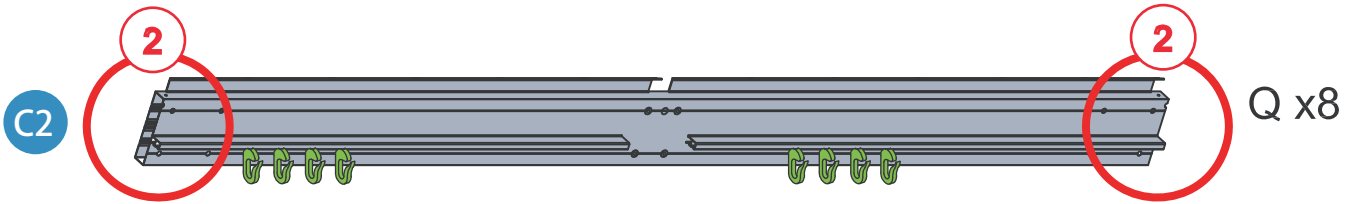
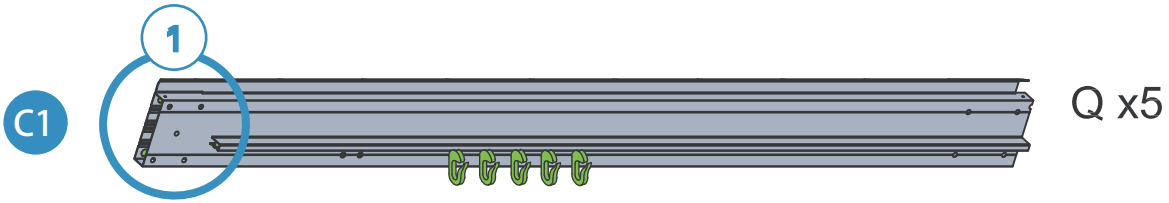



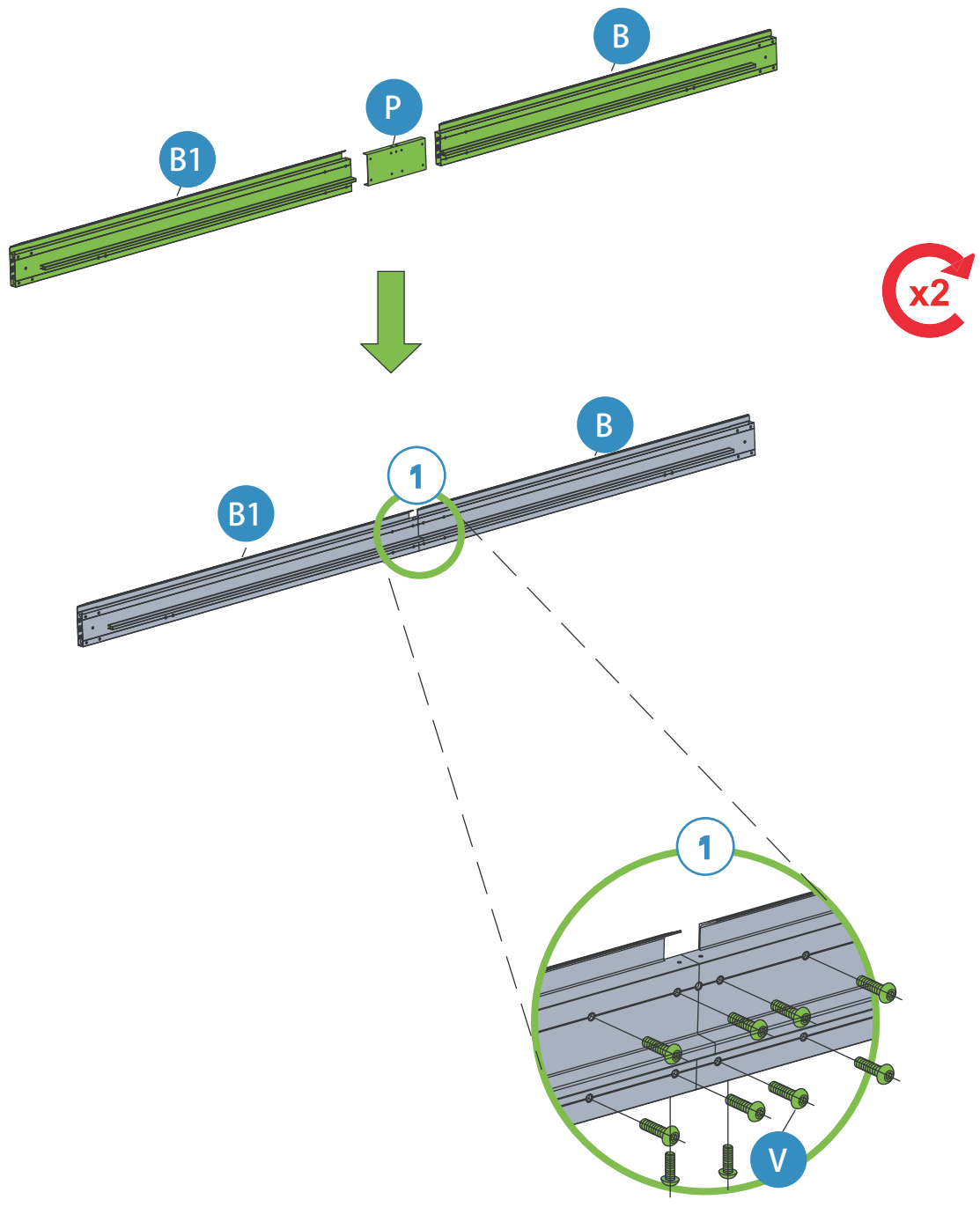
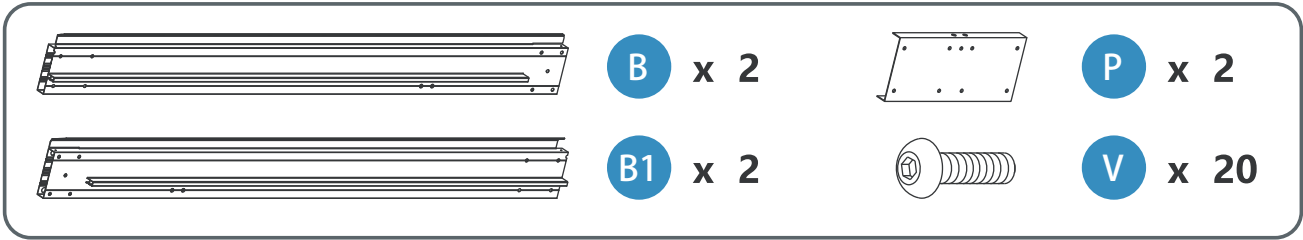

Install "Q" hooks in the quantity shown. Note: Insert all hooks into to the outer track.

4-1

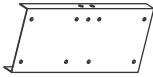

As shown in the diagram, use 10 "V" screws to connect parts B1/P/B. Note: Please ensure all screw holes are properly aligned before installation. Repeat the above steps for the remaining sections.

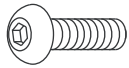
4-2

	C x 2		P x 4
	C1 x 2		V x 40
	C2 x 2		

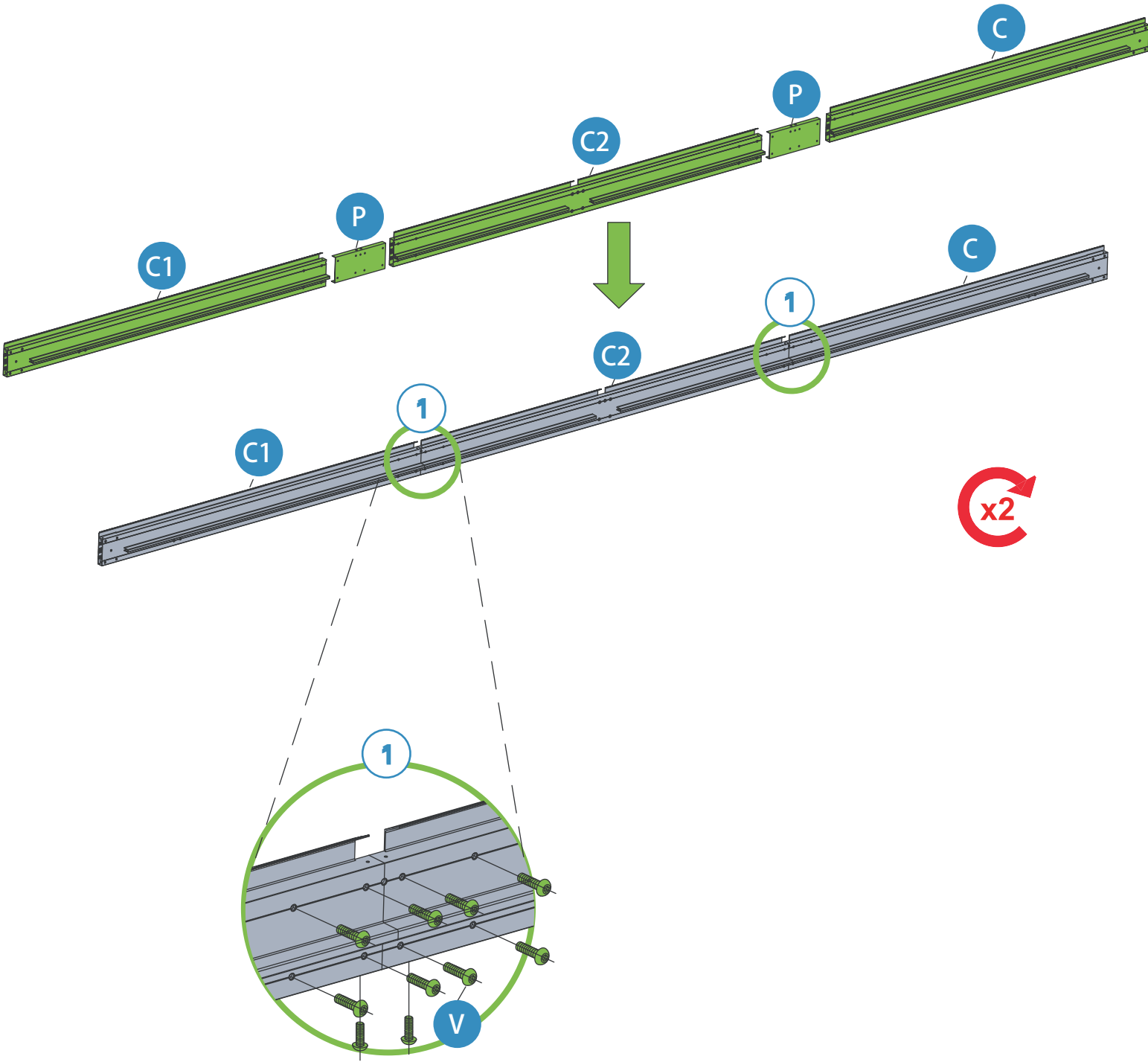

As shown in the diagram, use 20 "V" screws to connect parts C1/P/C2/P/C. Note: Please ensure all screw holes are properly aligned before installation. Repeat the above steps for the remaining sections.

5

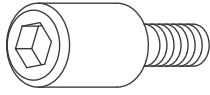

X x 32

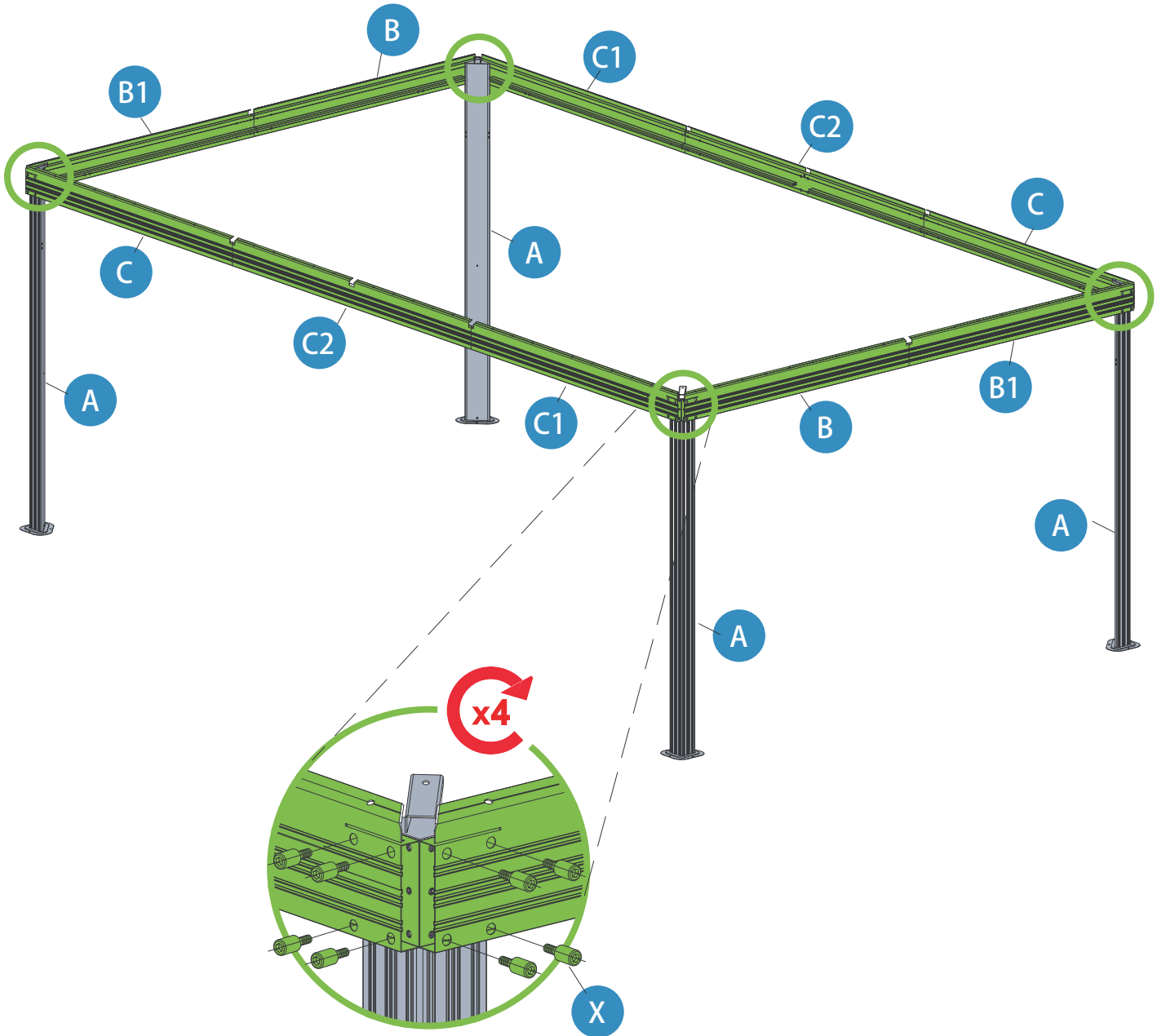

6

 **F** x 4

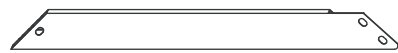
 **F1** x 4

 **M6** x 8

 **V1** x 16

 **V** x 16

 **V2** x 8

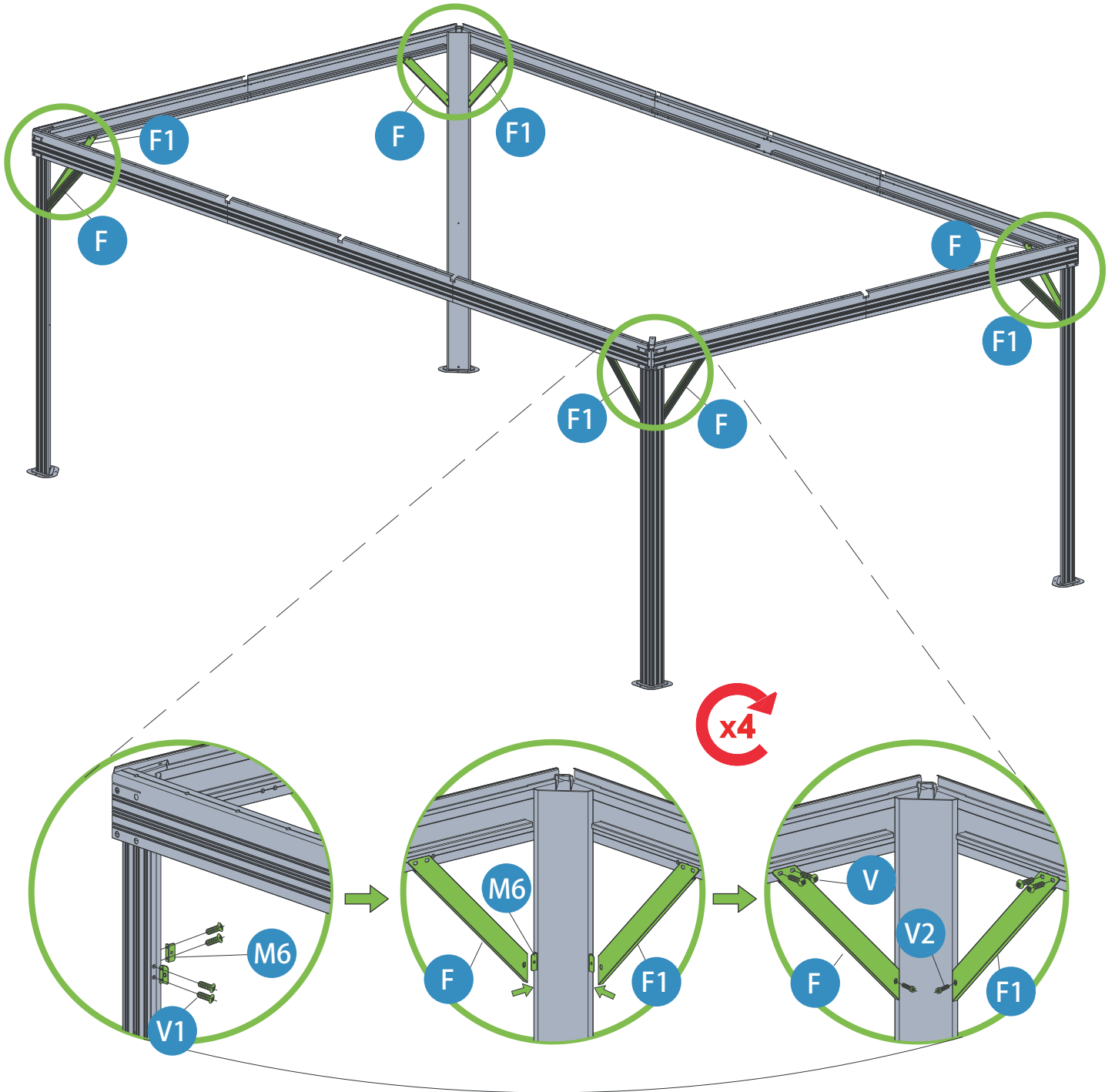

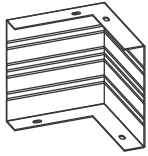

J1 x 4



J2 x 6

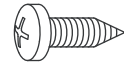

Y x 34

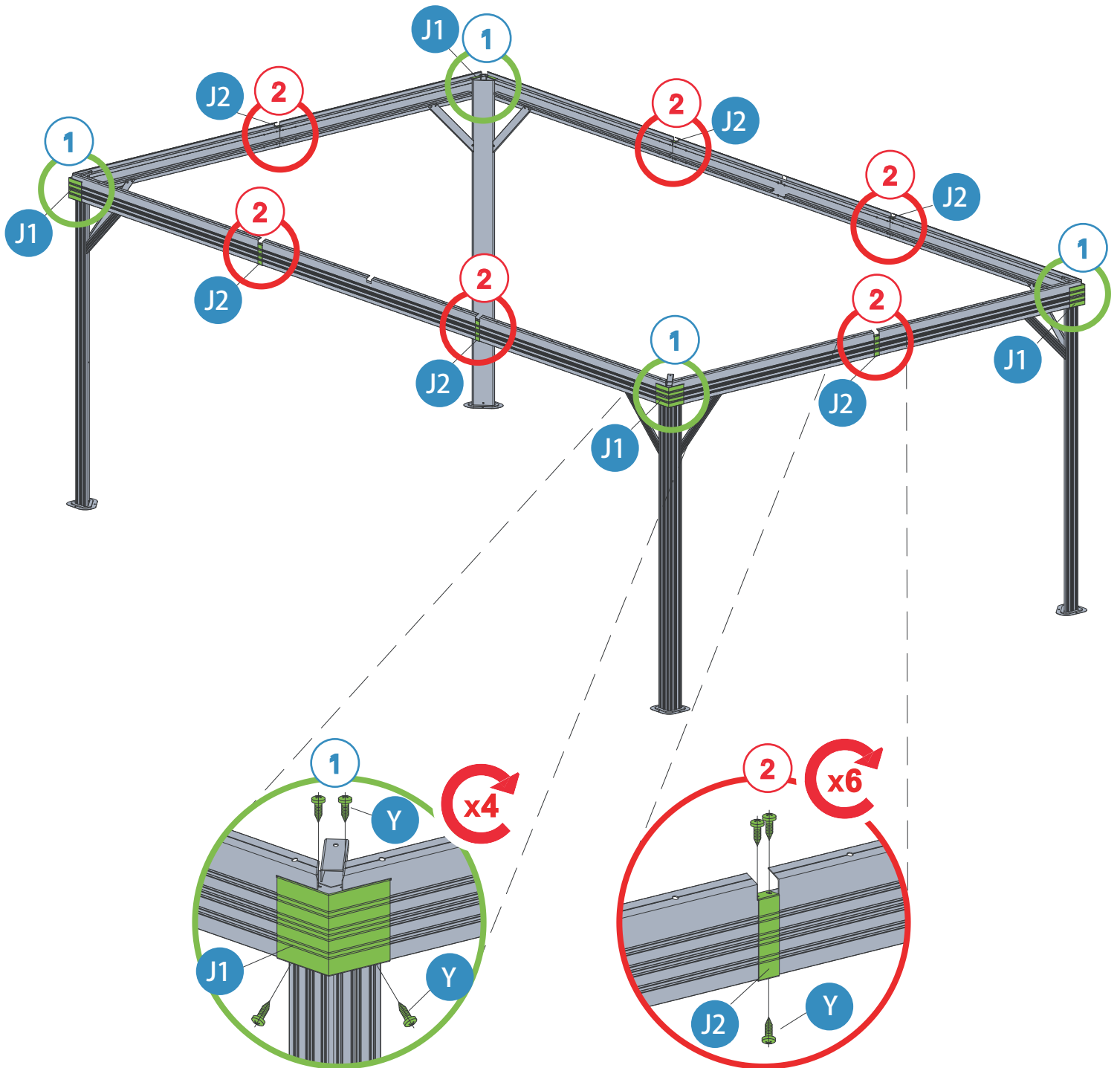

K1 x 1 D4 x 6
D x 6 V x 18

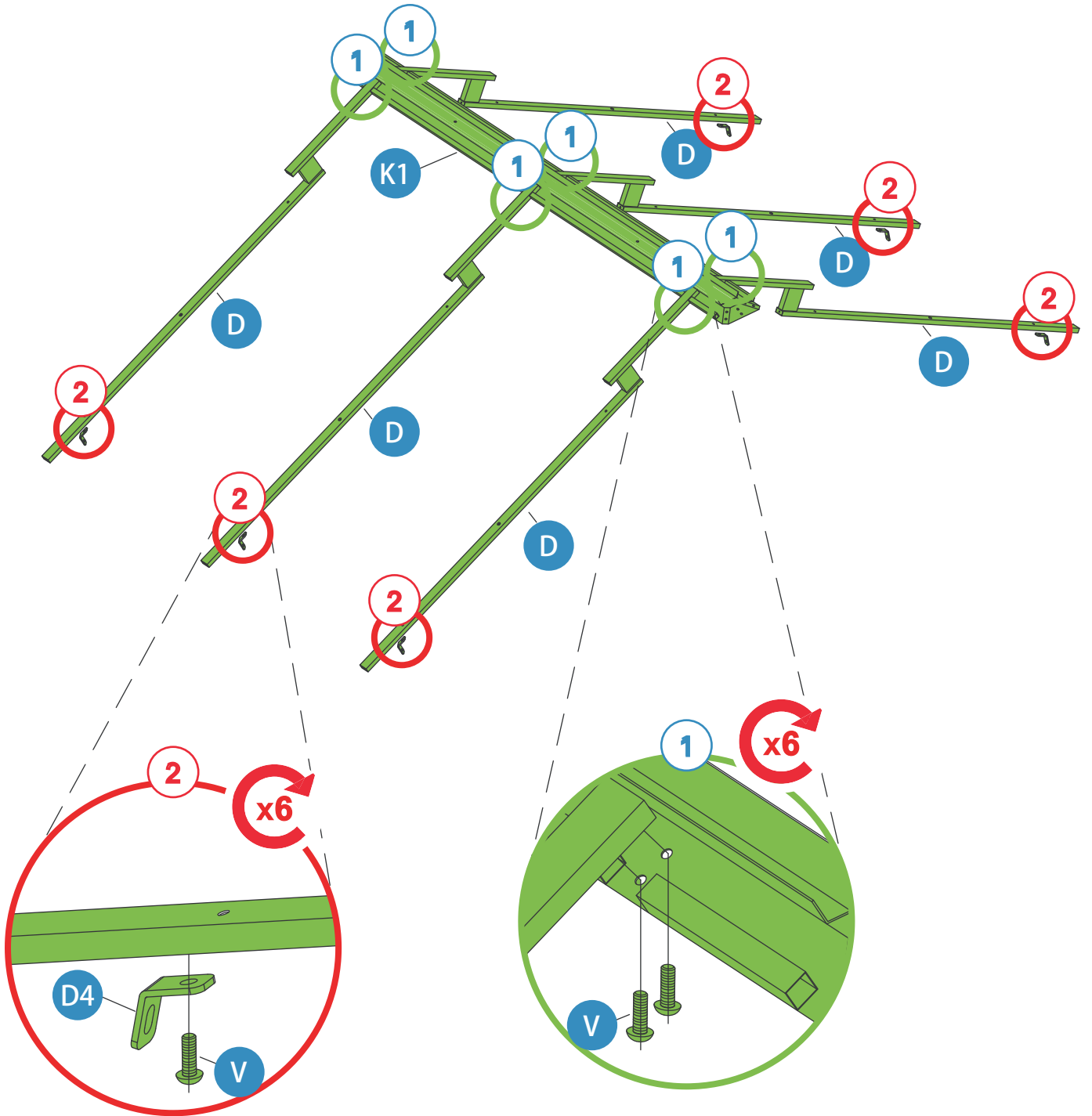

9

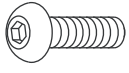

V x 6

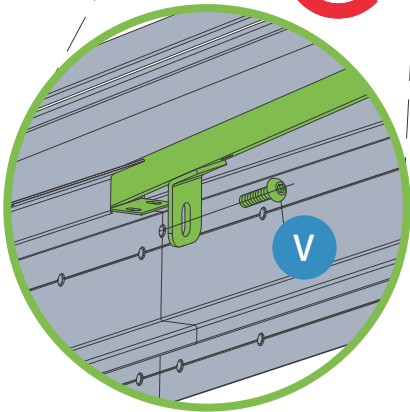
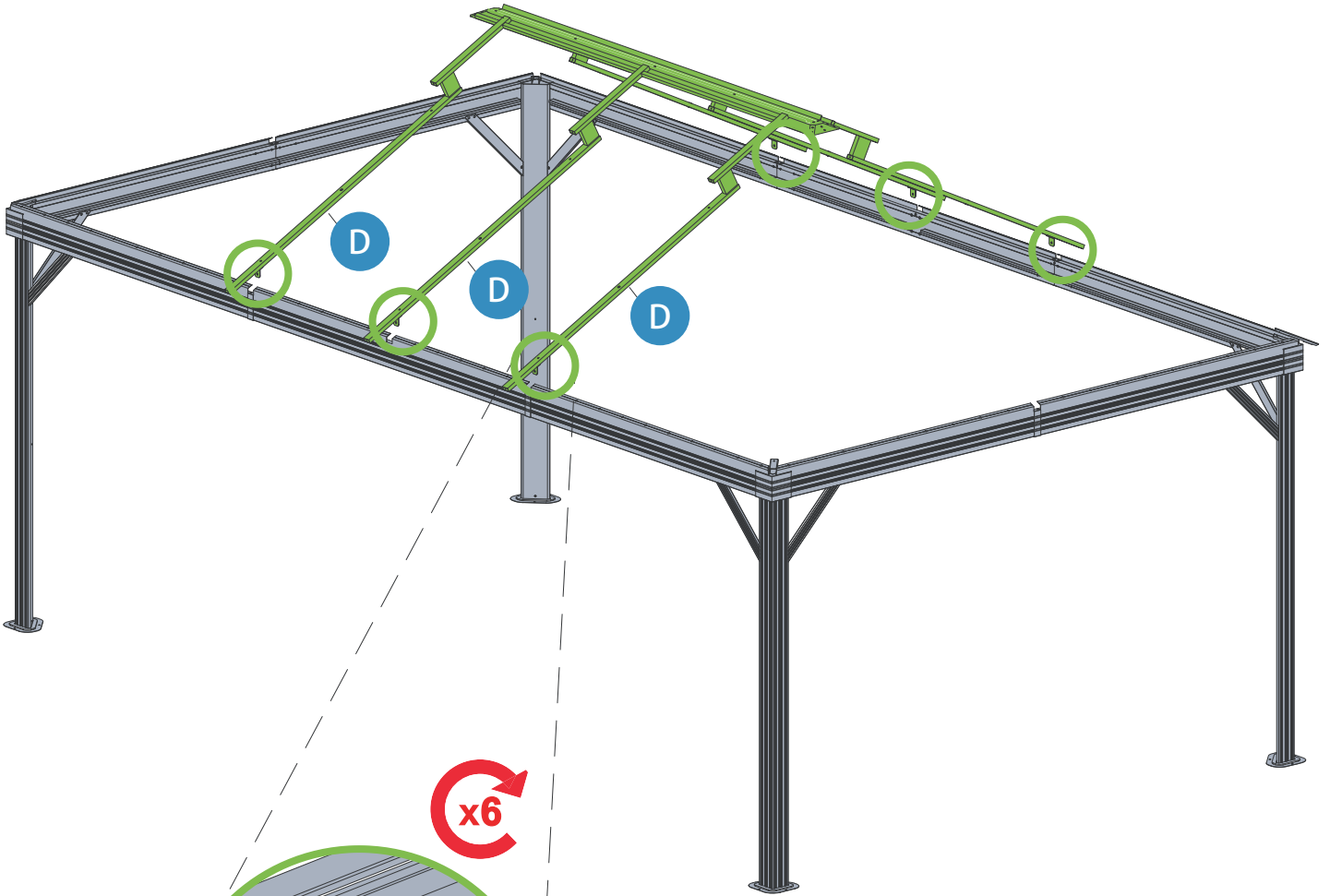

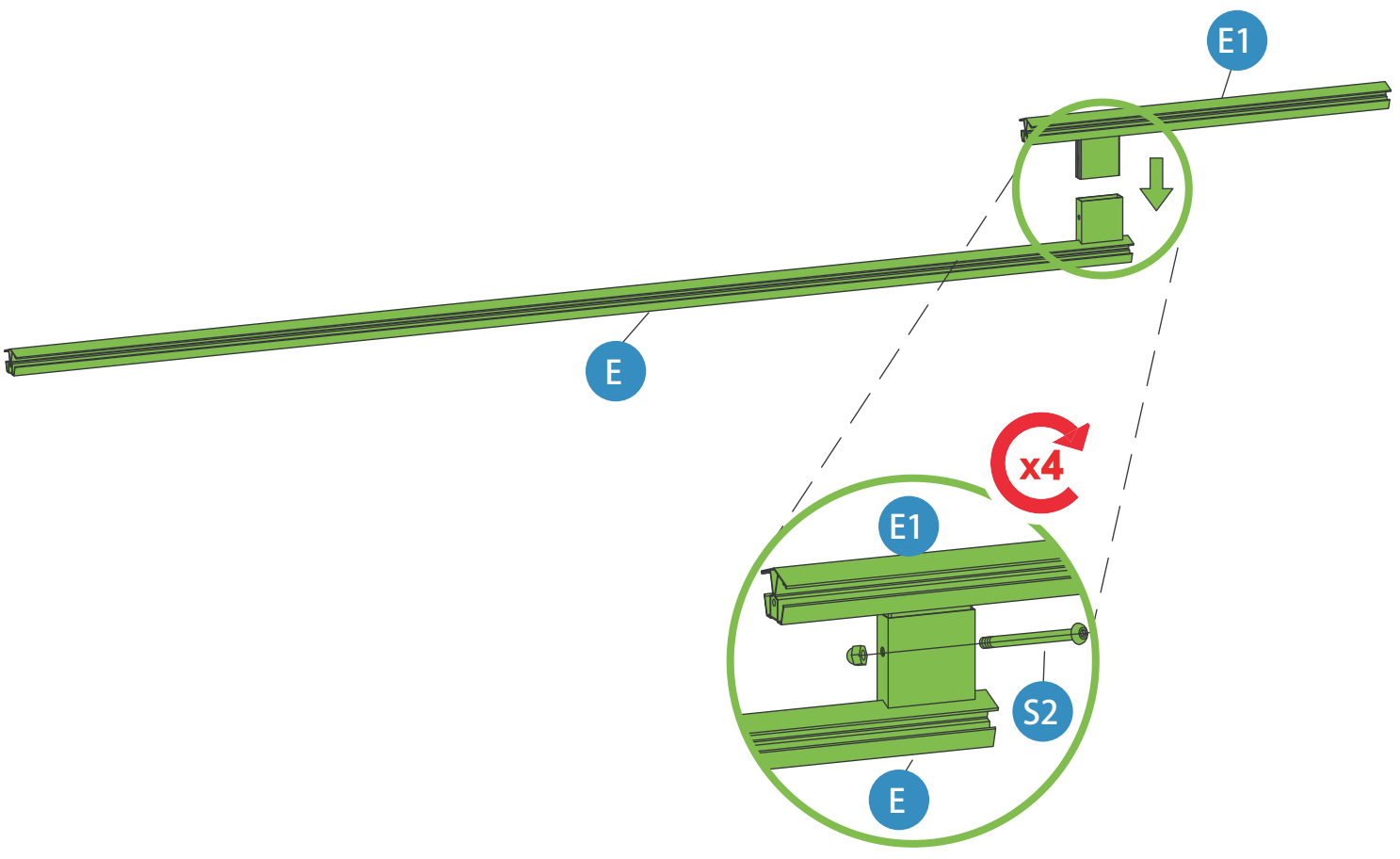
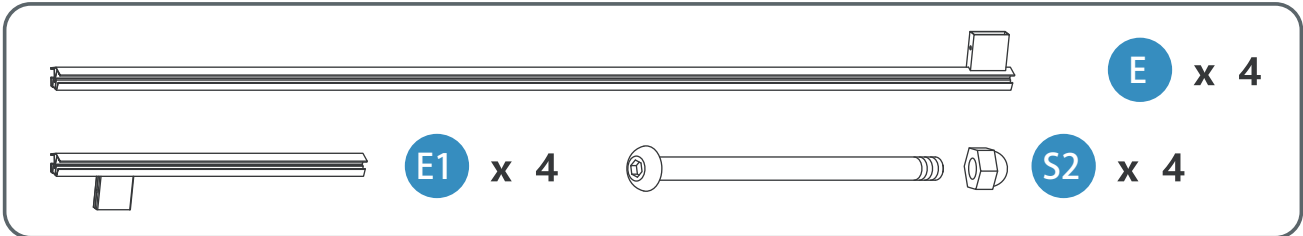

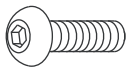

V x 12

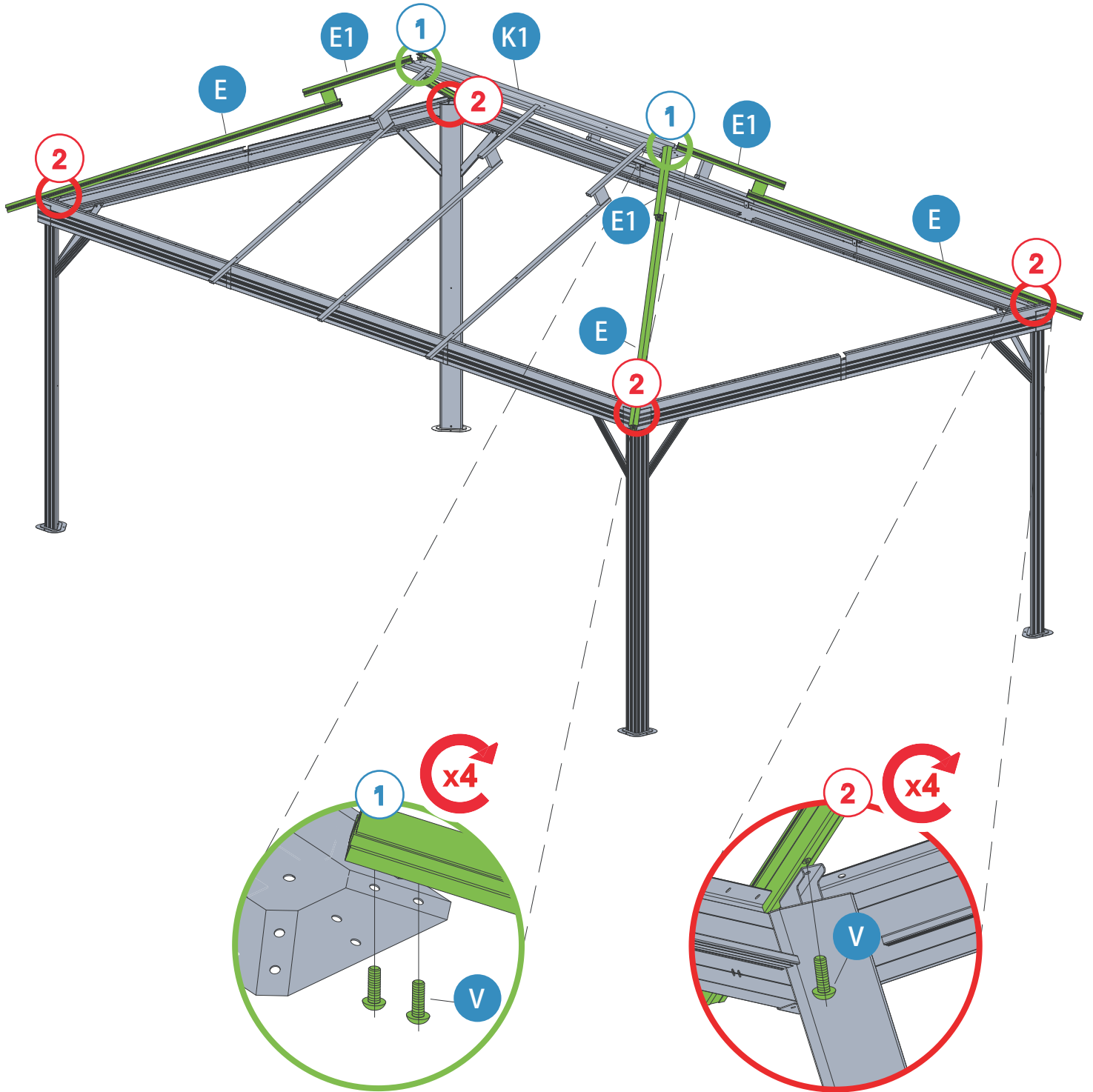

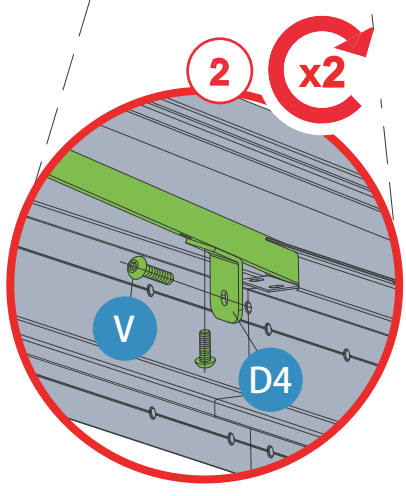
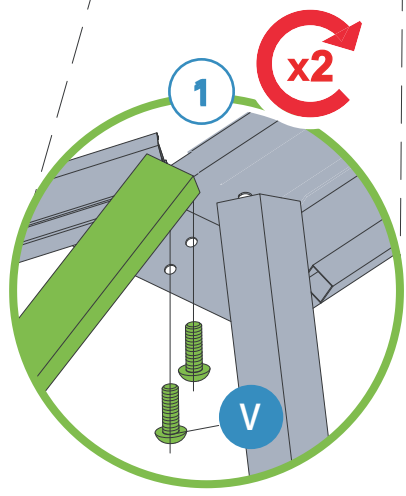
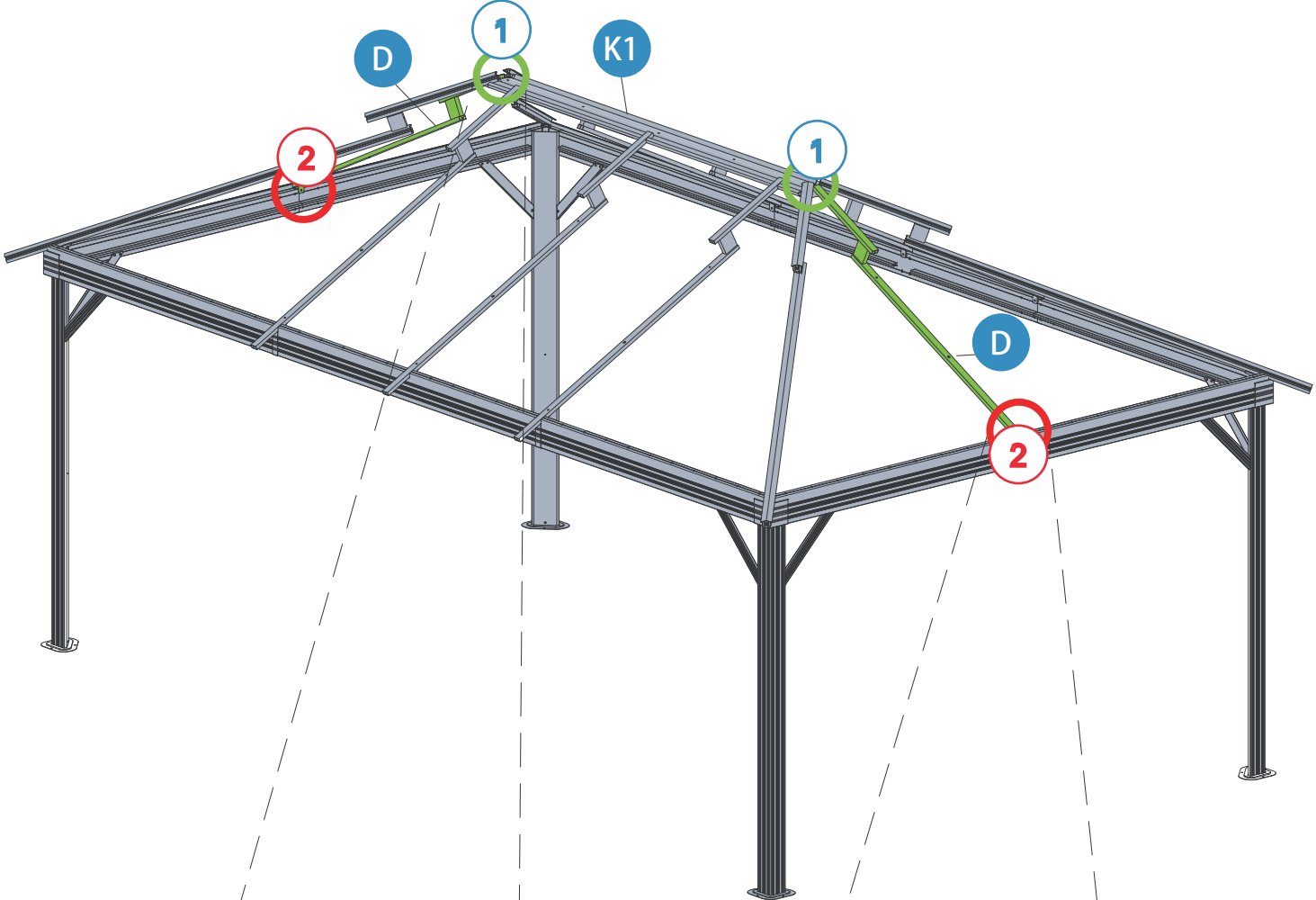
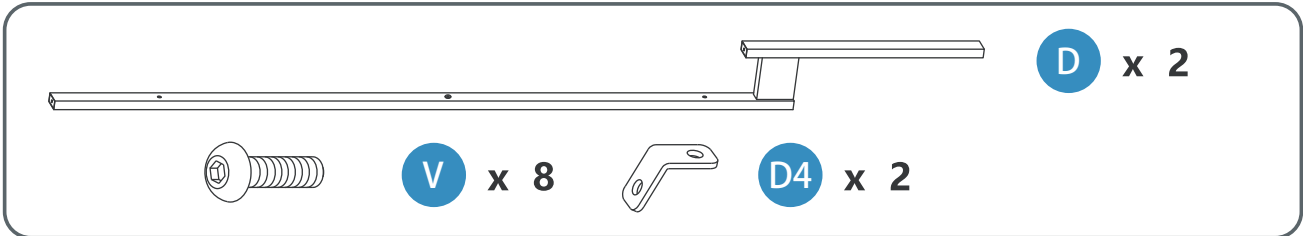

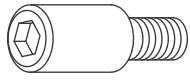



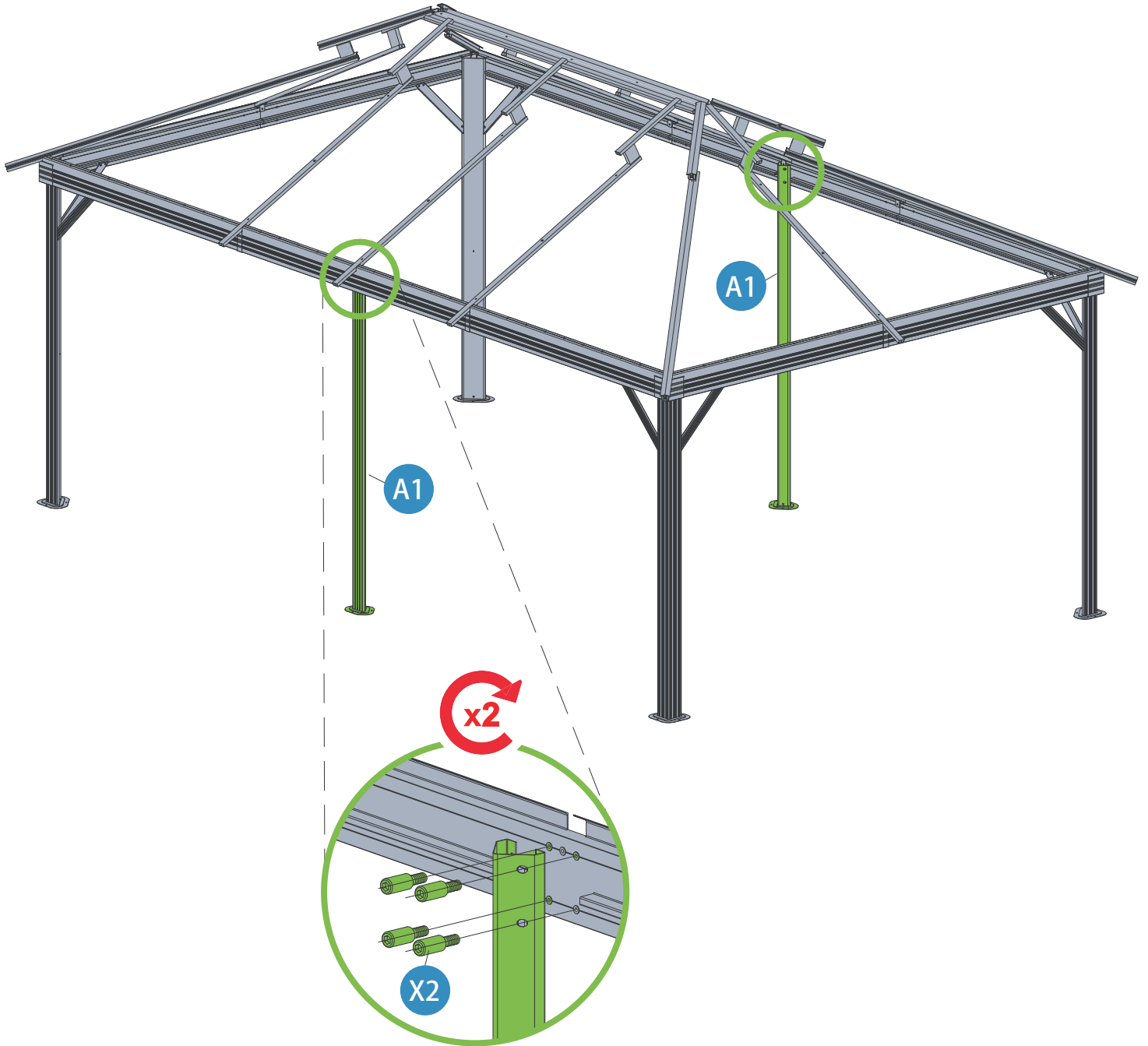

X2 x 8

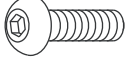

-  **J3** x 2
-  **J4** x 2
-  **J** x 2
-  **M1** x 2
-  **M2** x 4
-  **V** x 12

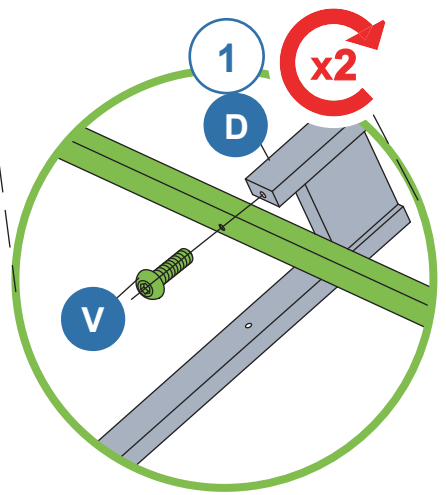
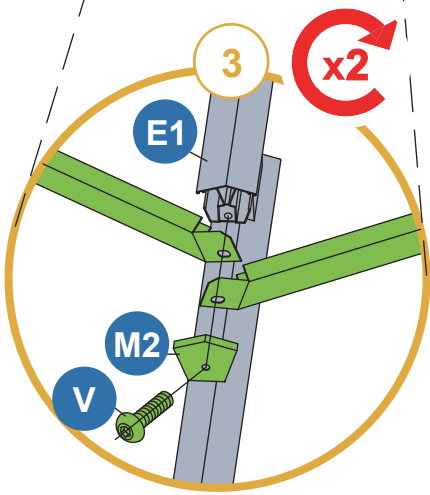
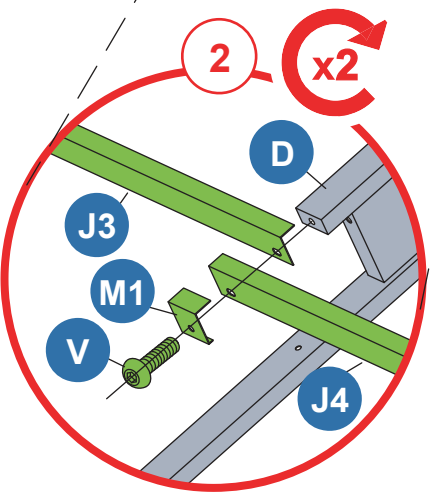
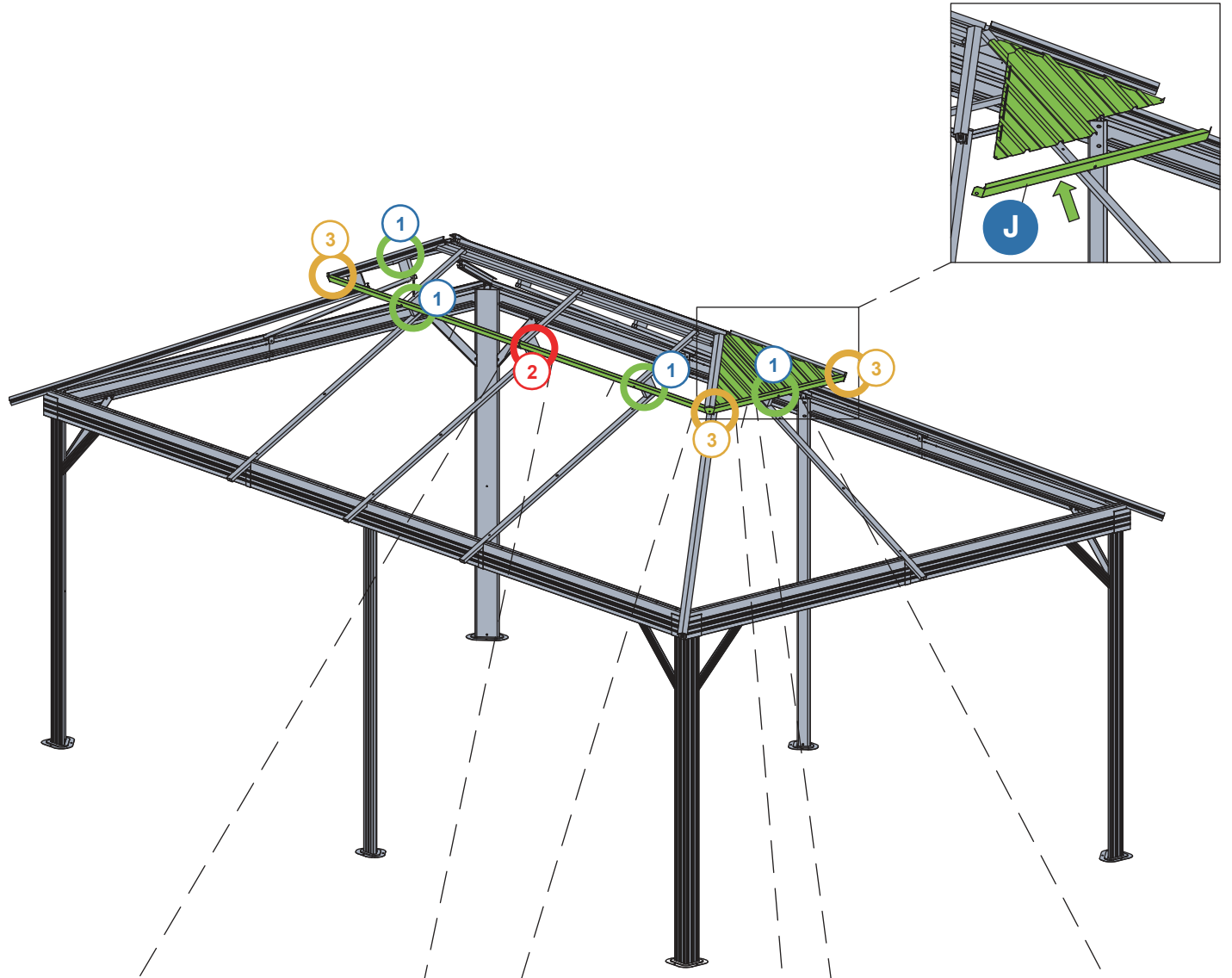

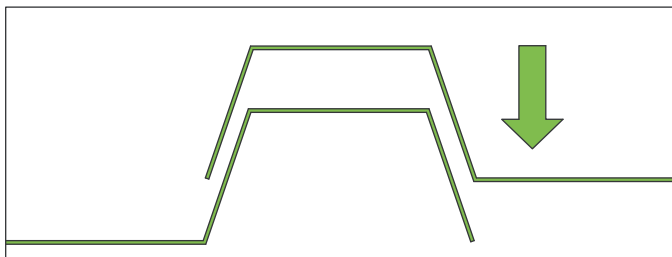
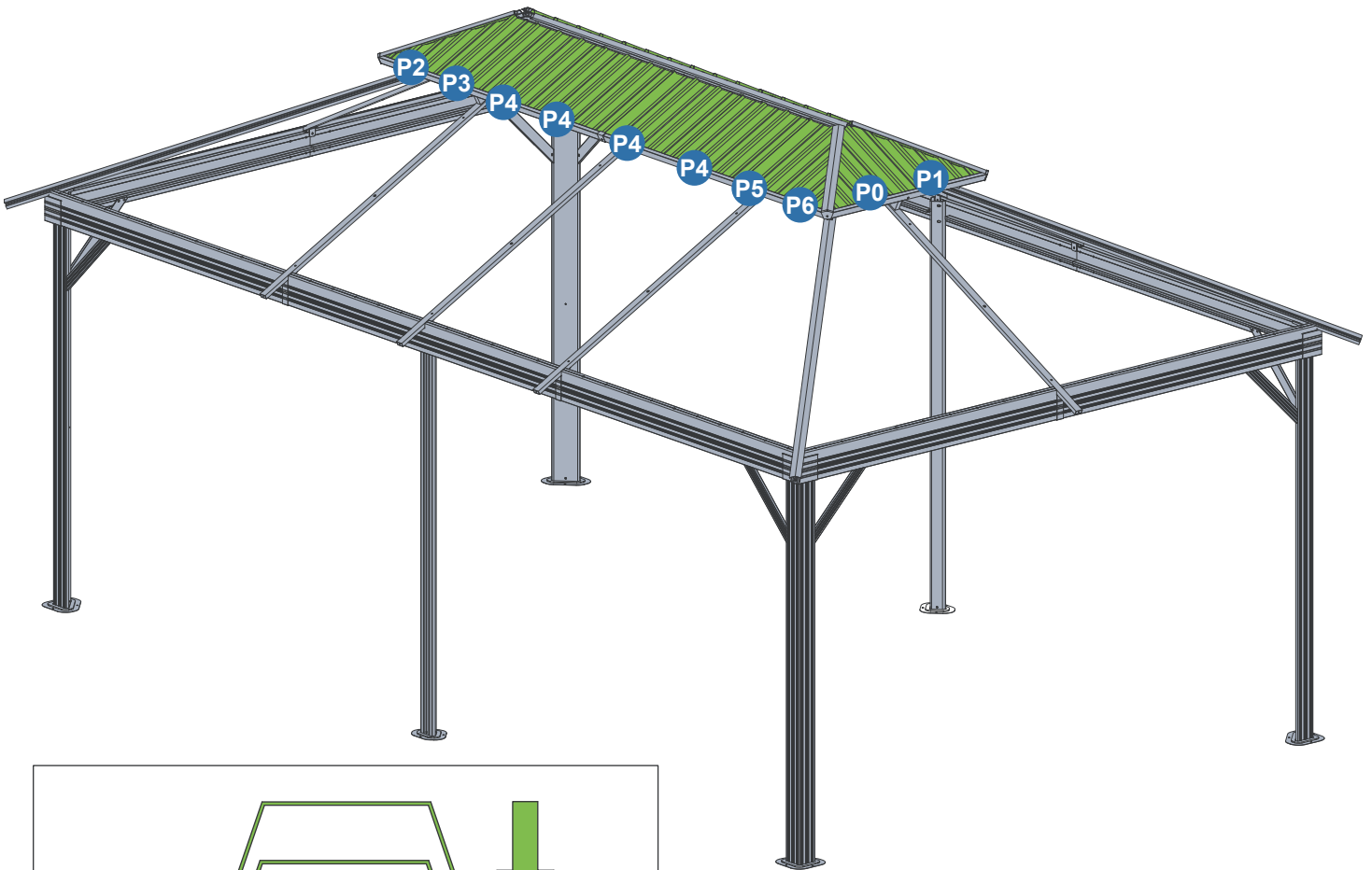
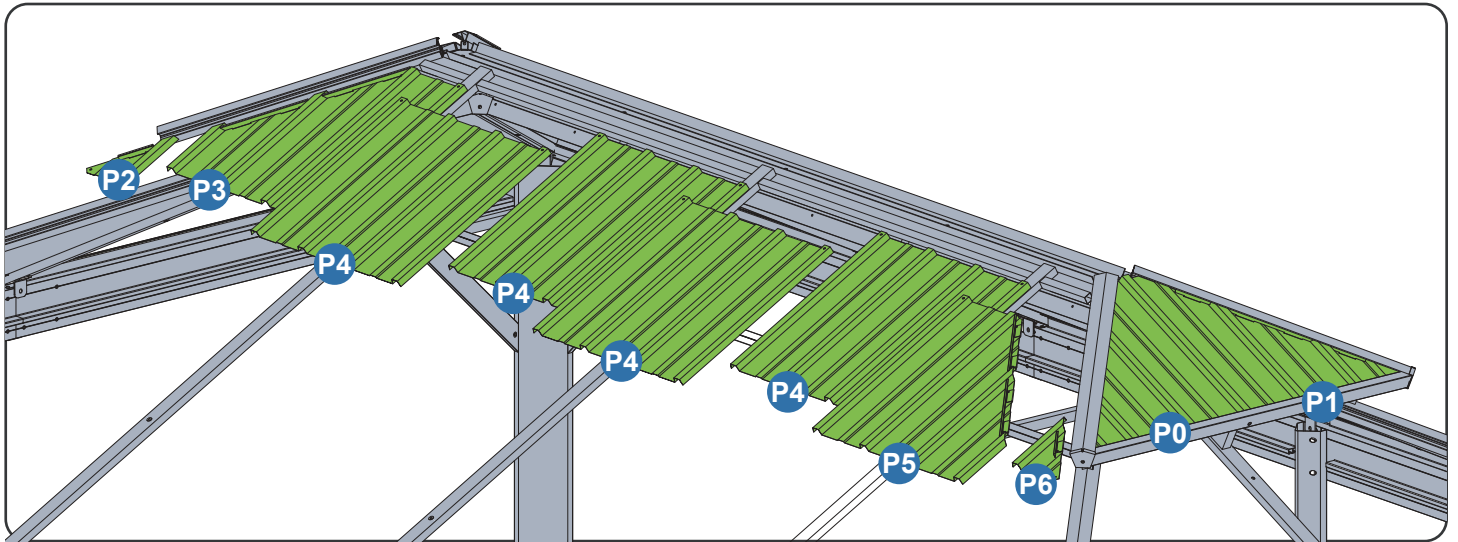

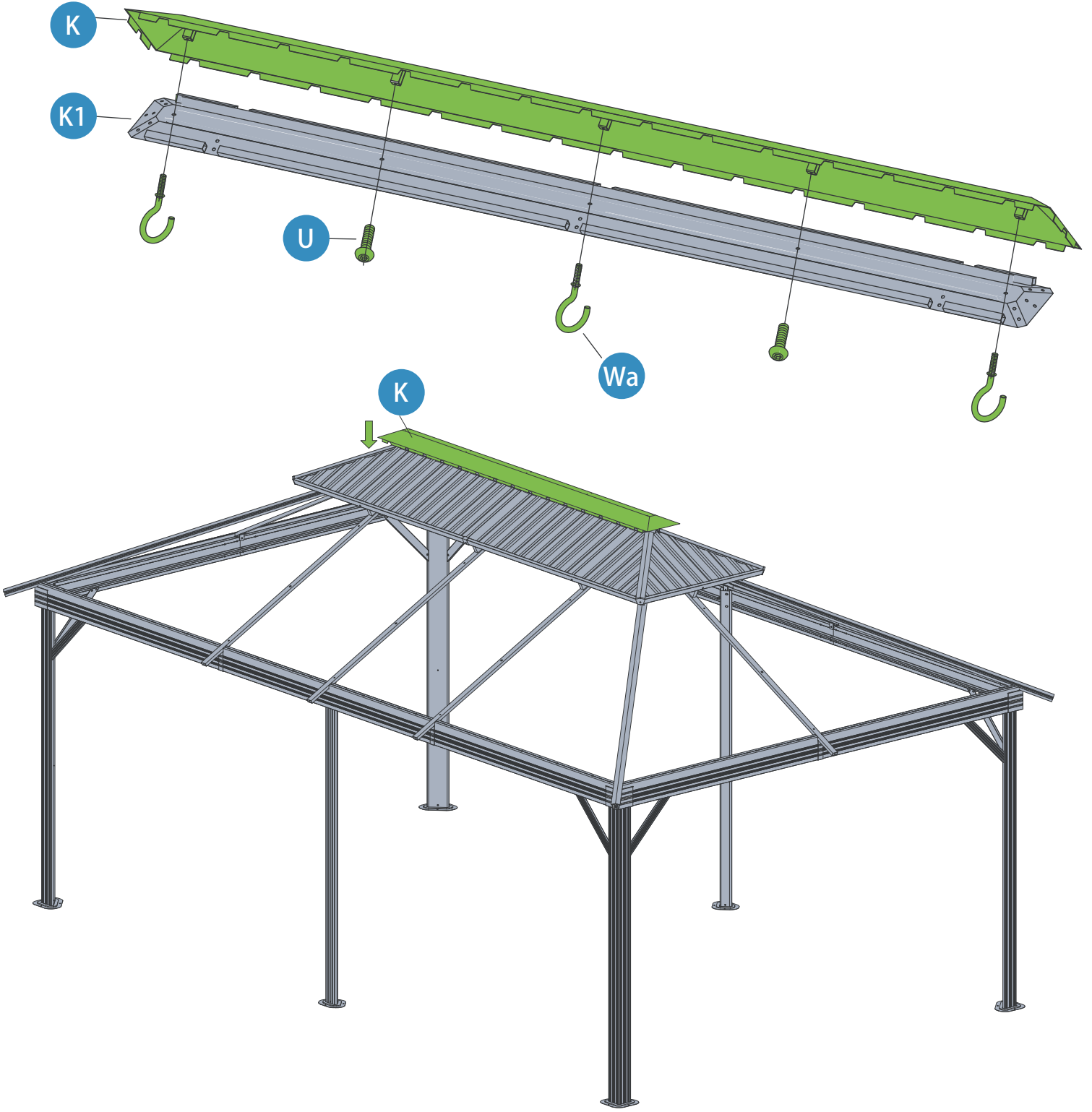
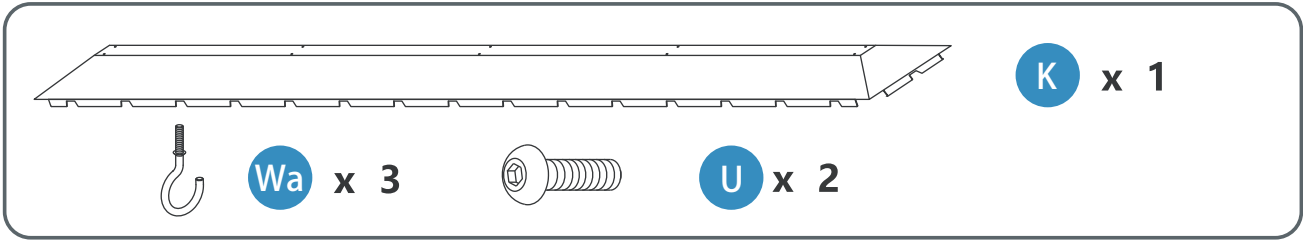

Note: Be cautious when installing the metal sheet to avoid falling or sharp-edge injuries.

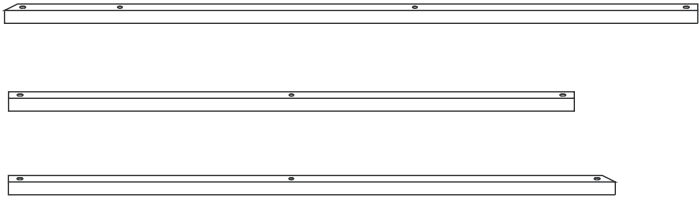

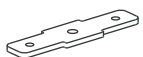
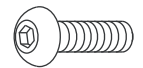

- I x 4  M3 x 8
- G x 4  V x 36
- H x 4  M4 x 4

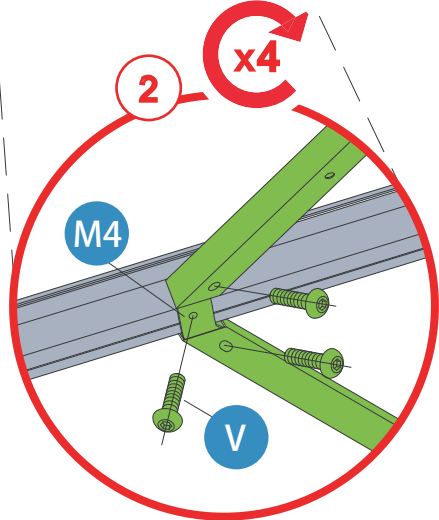
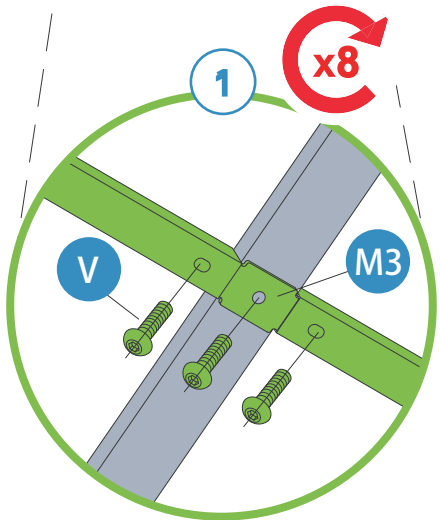
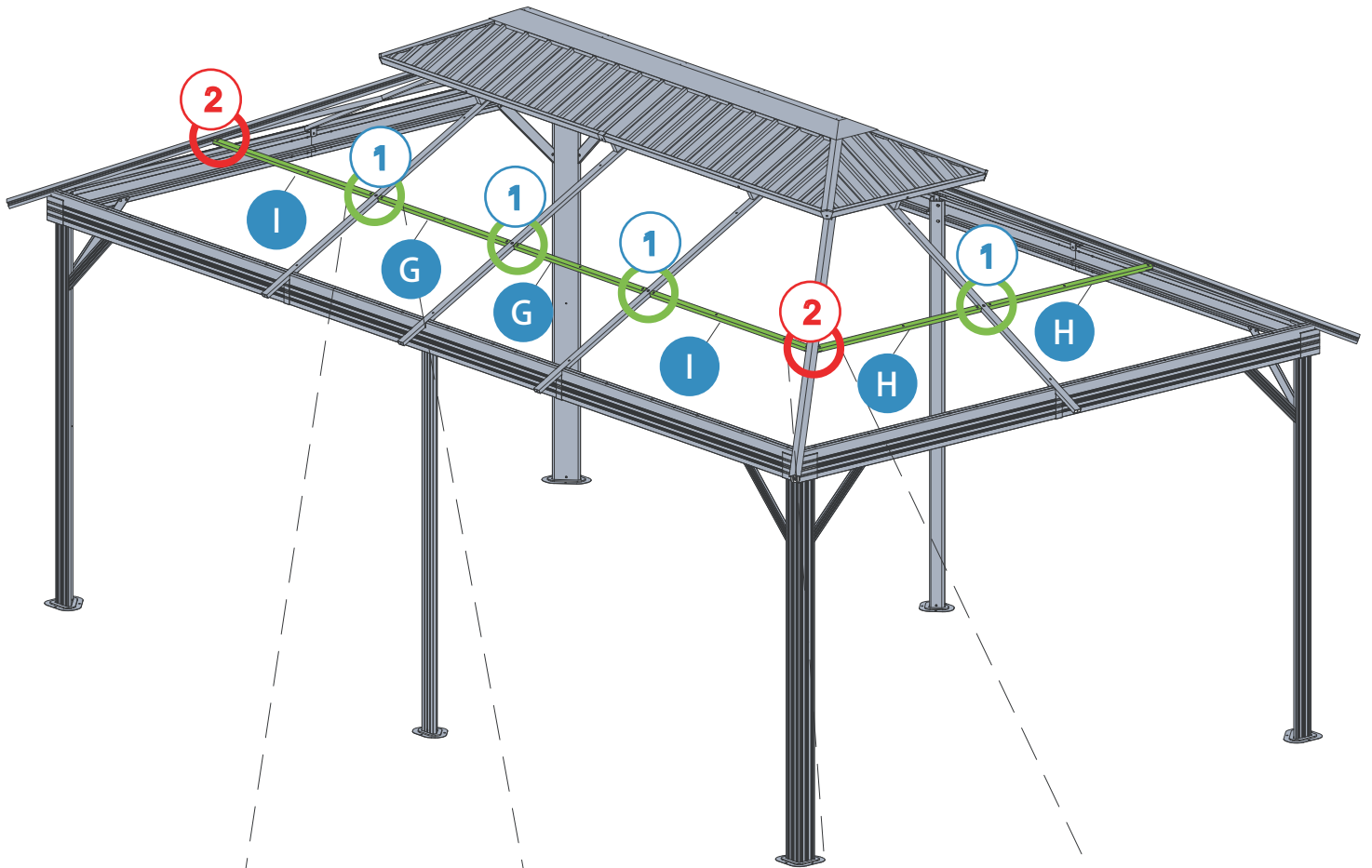

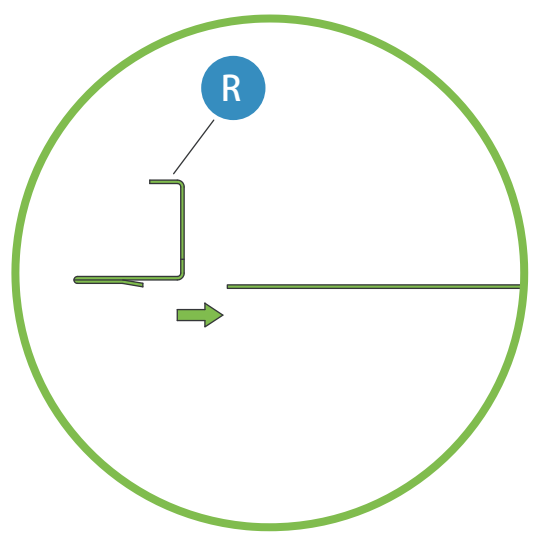
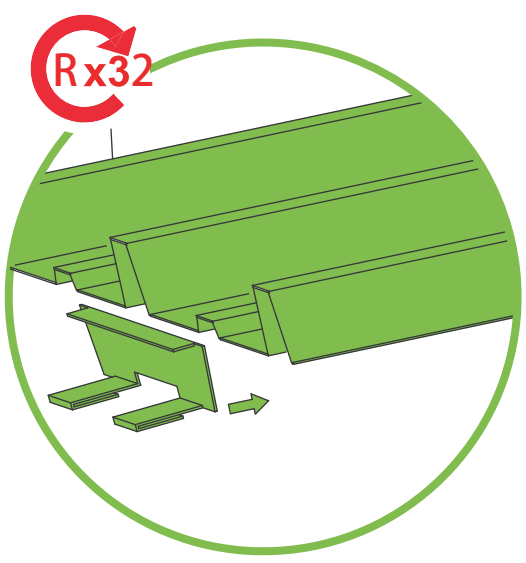
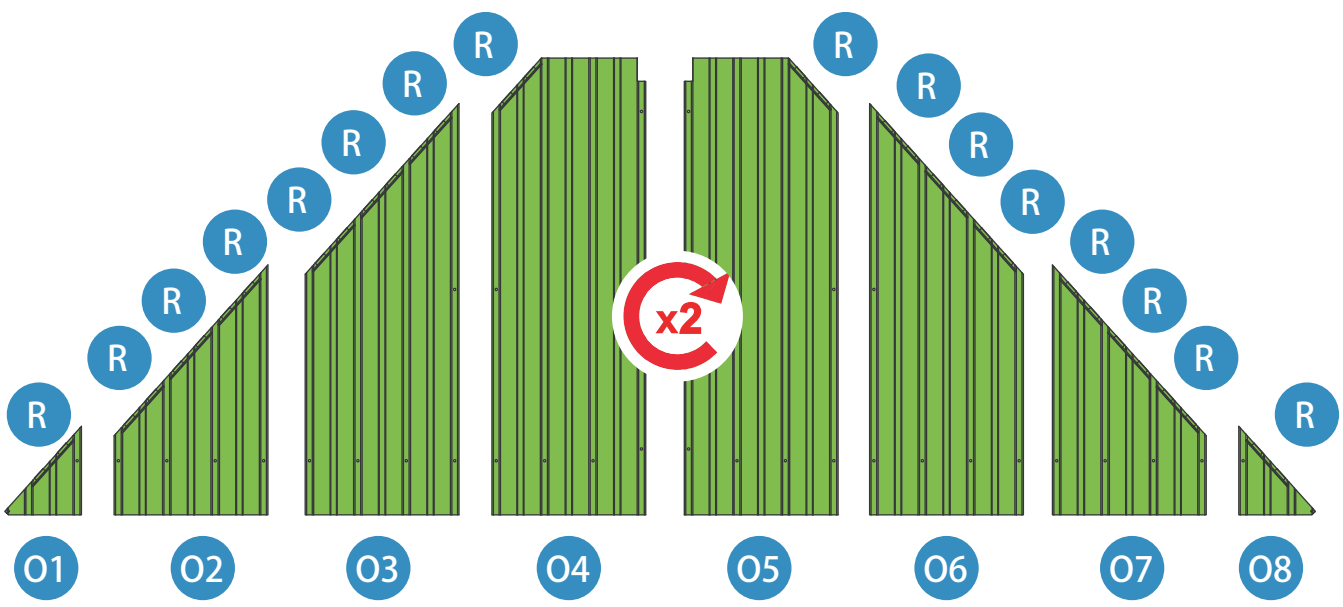
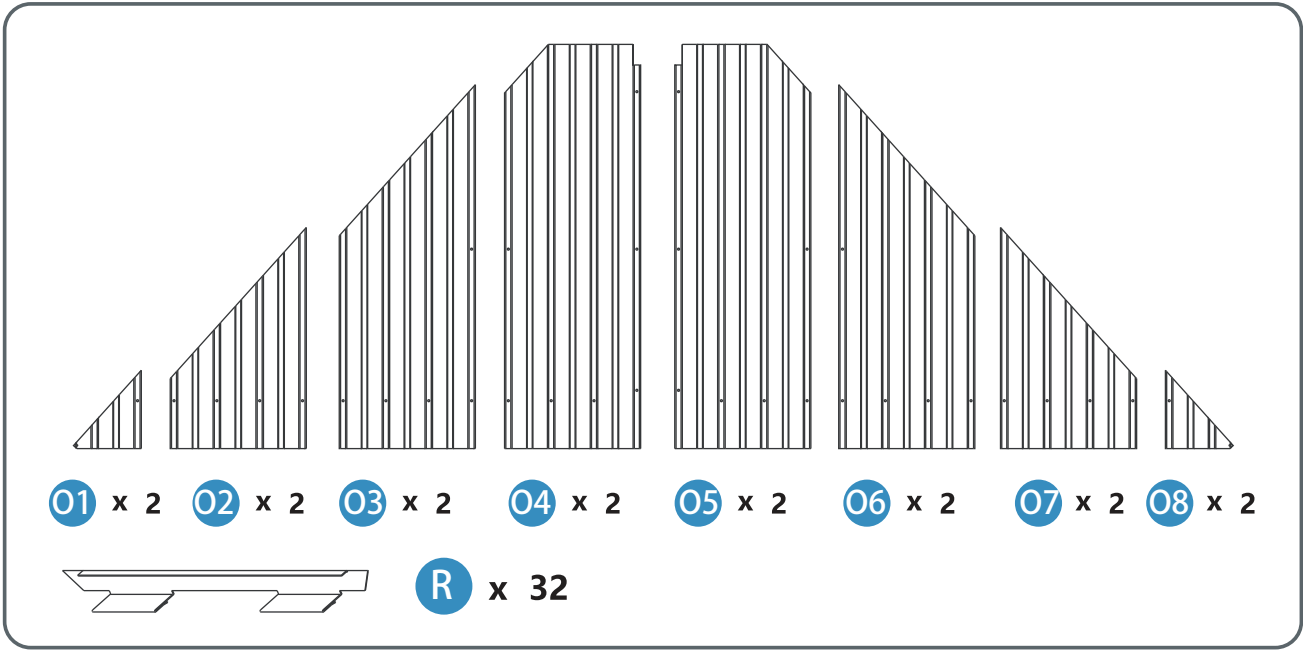

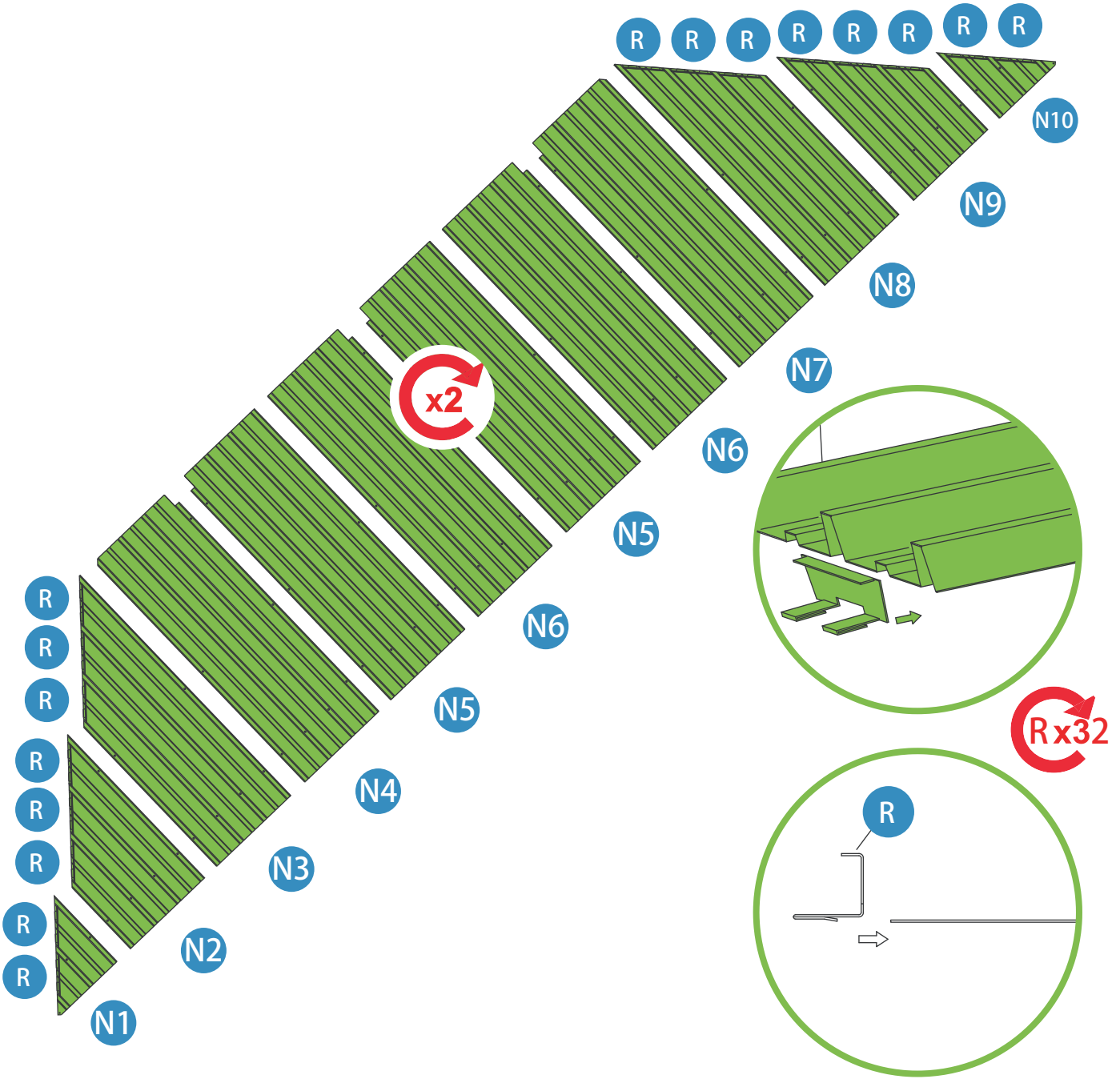
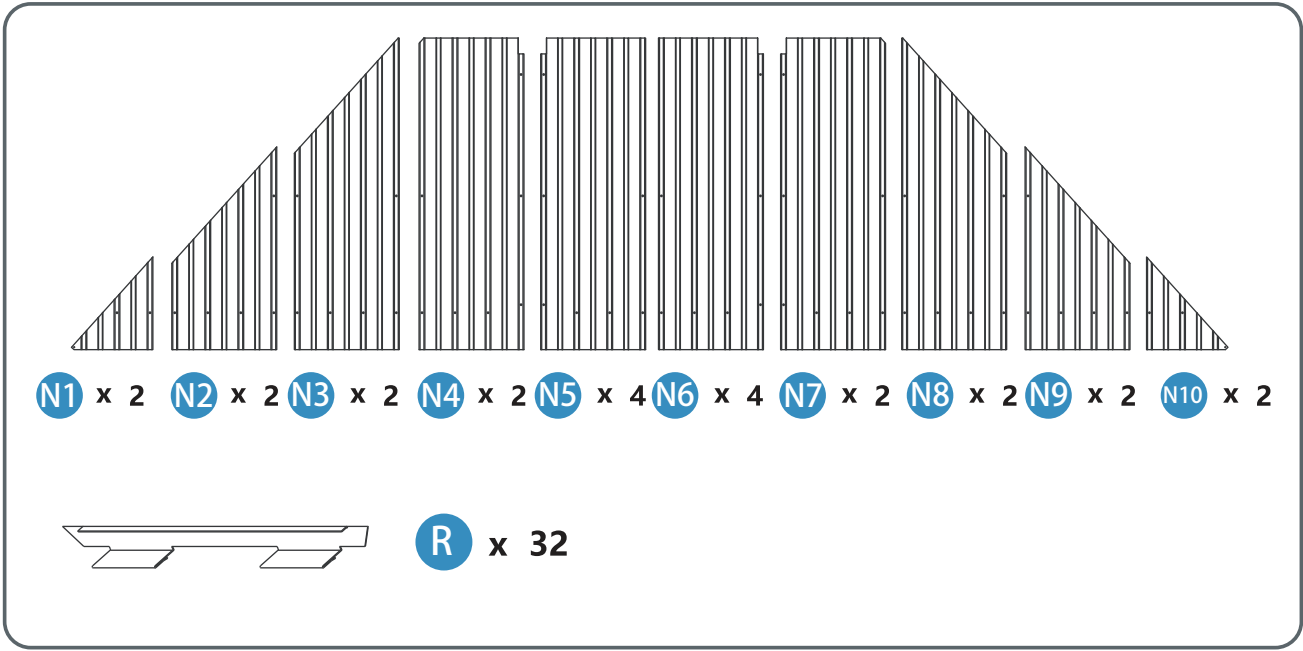

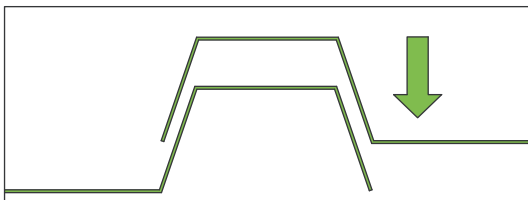
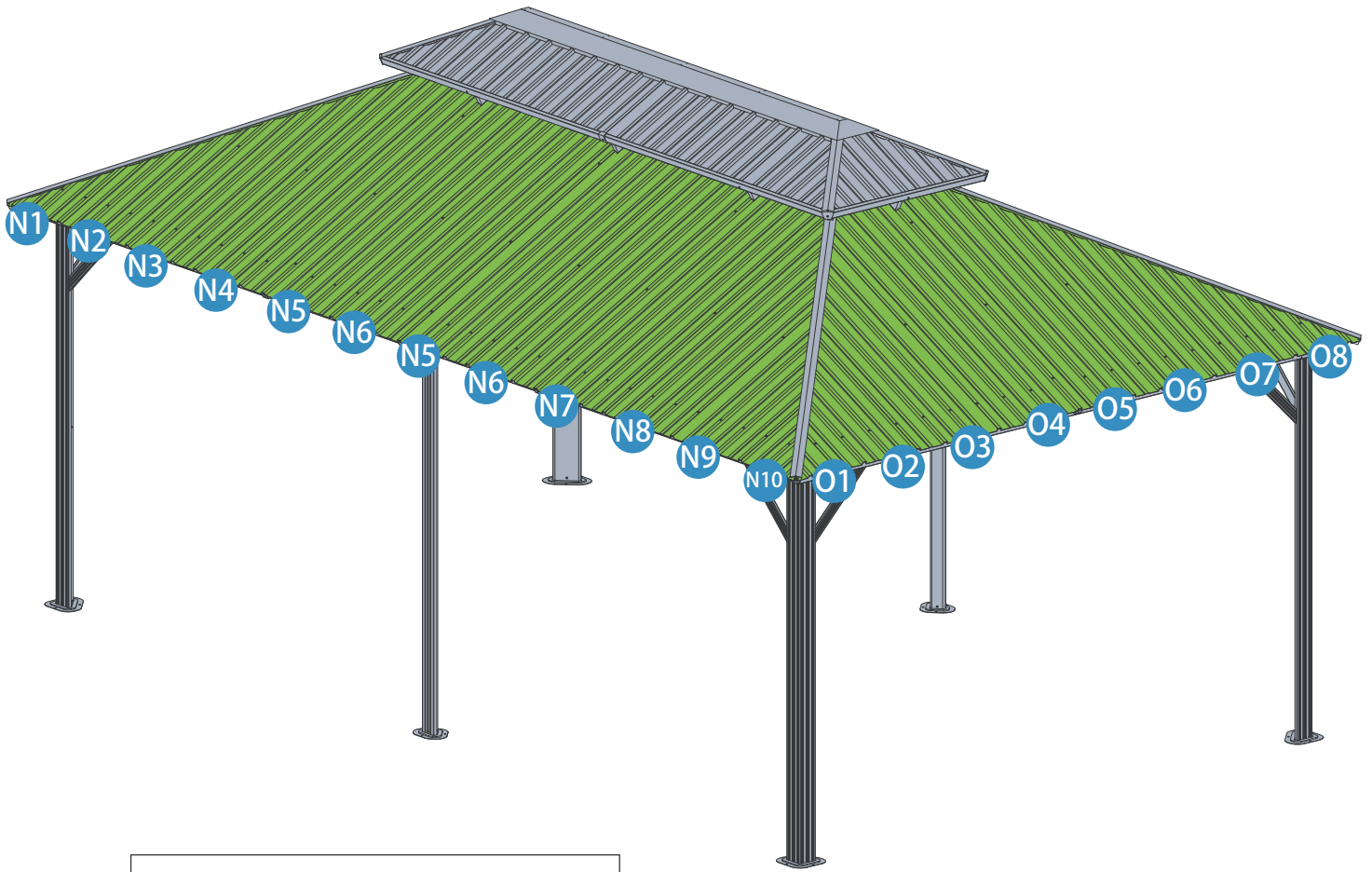
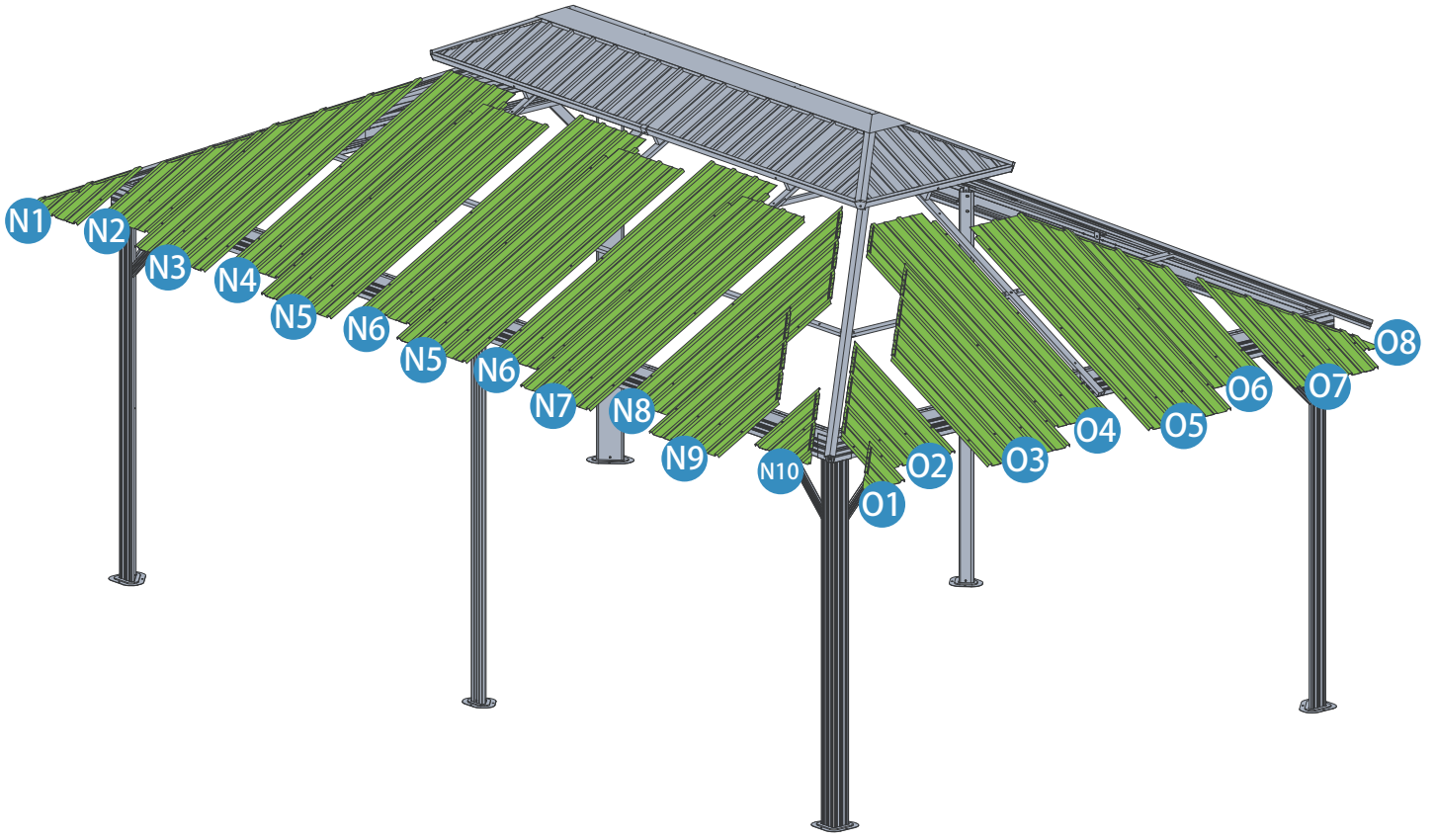

22-1

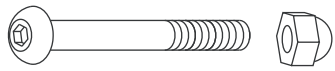

S x 16

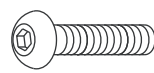

U x 8



M5 x 24

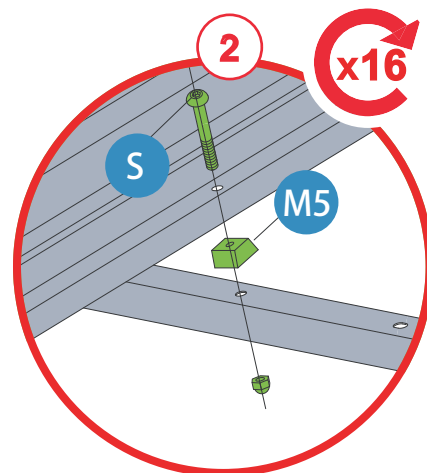
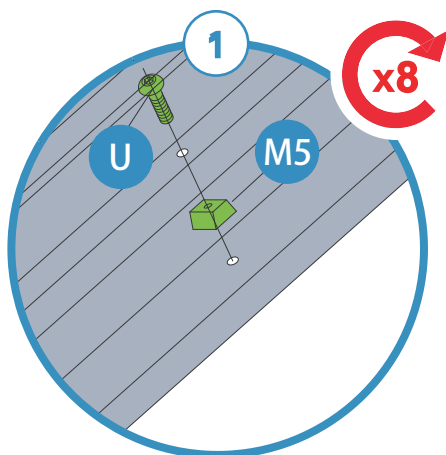
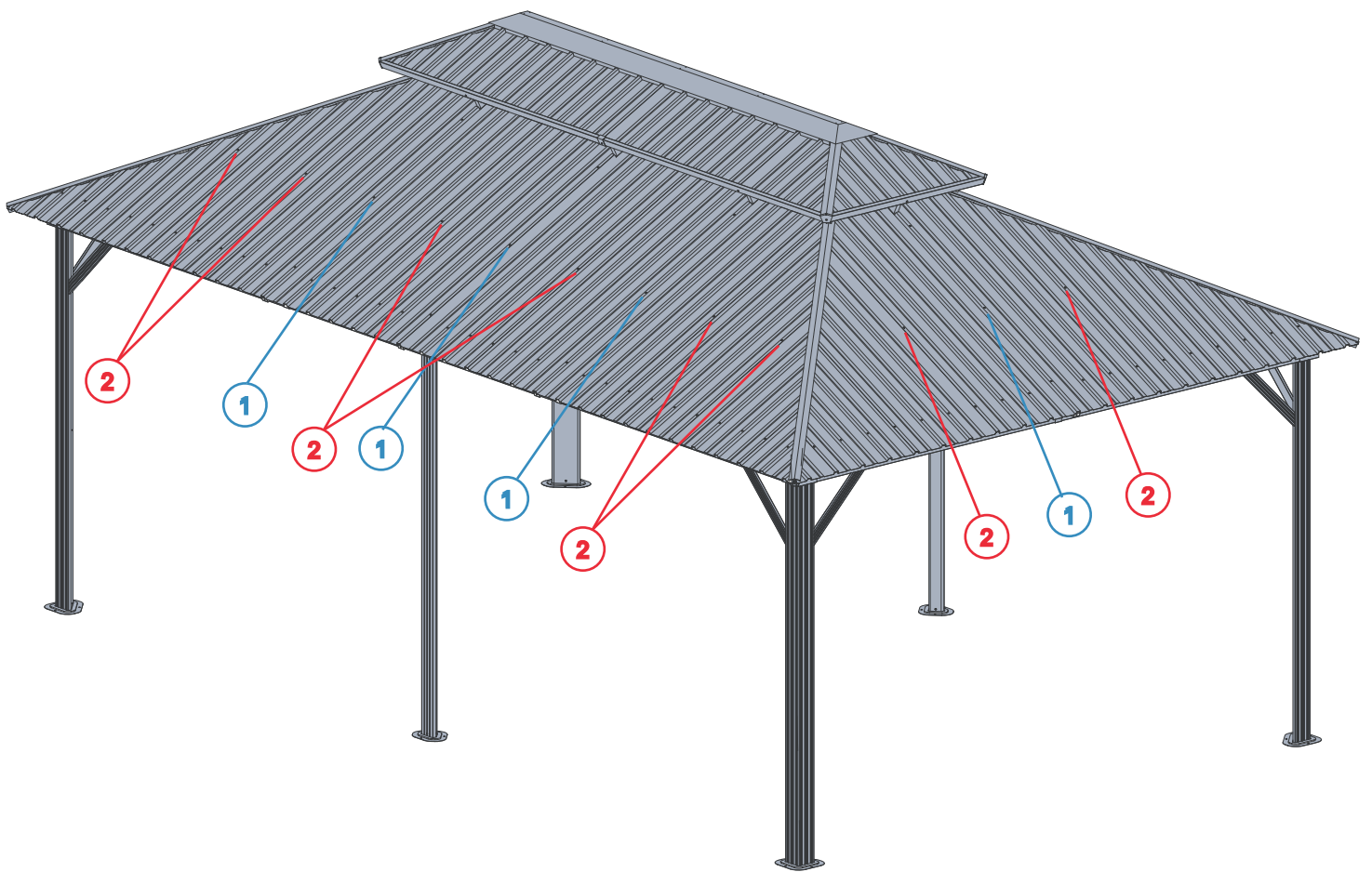
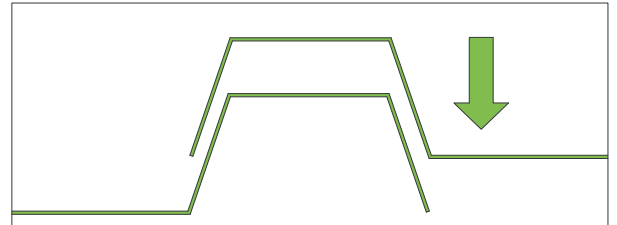

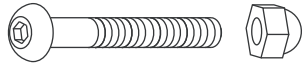

X1 x 12



M5 x 108

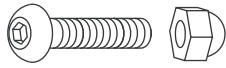

T x 96

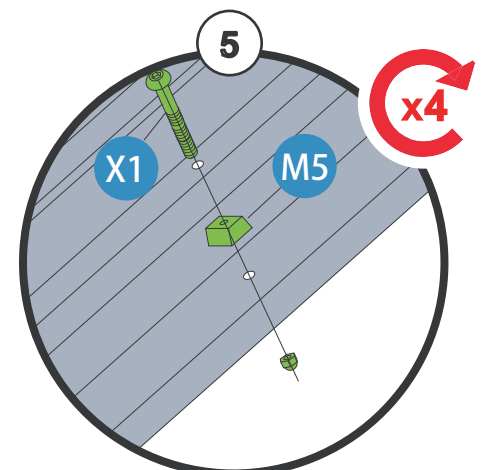
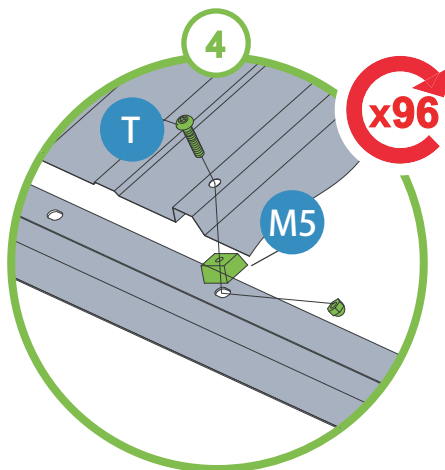
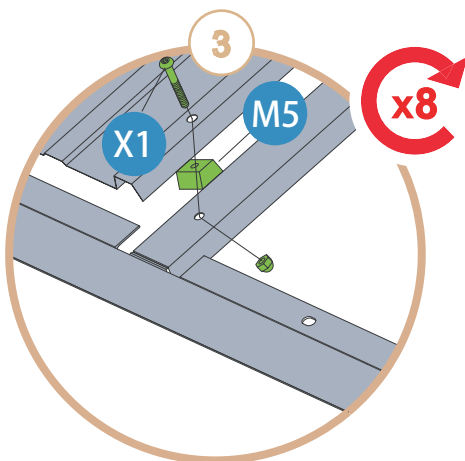
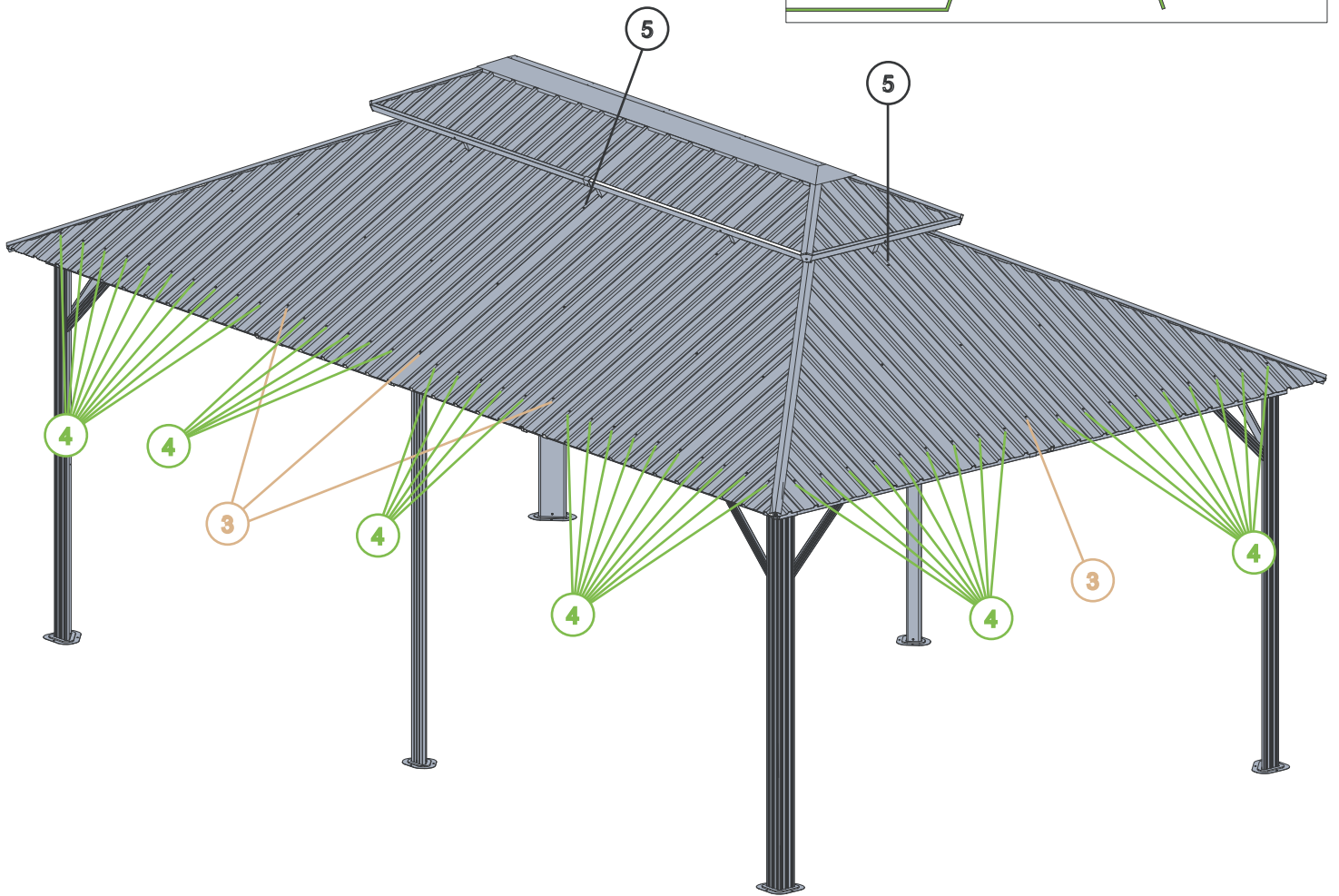
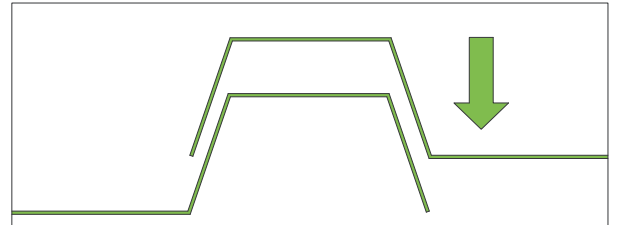

- G1 x 2
- G2 x 2
- G3 x 2
- G4 x 2
- G5 x 2
- M1 x 6
- M2 x 4
- V x 12

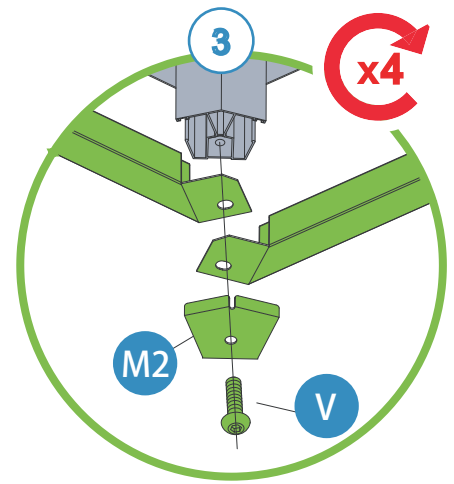
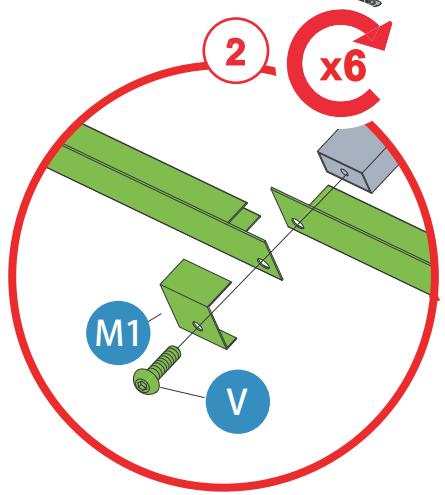
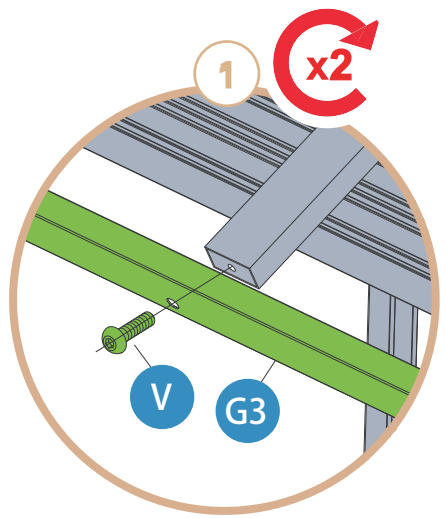
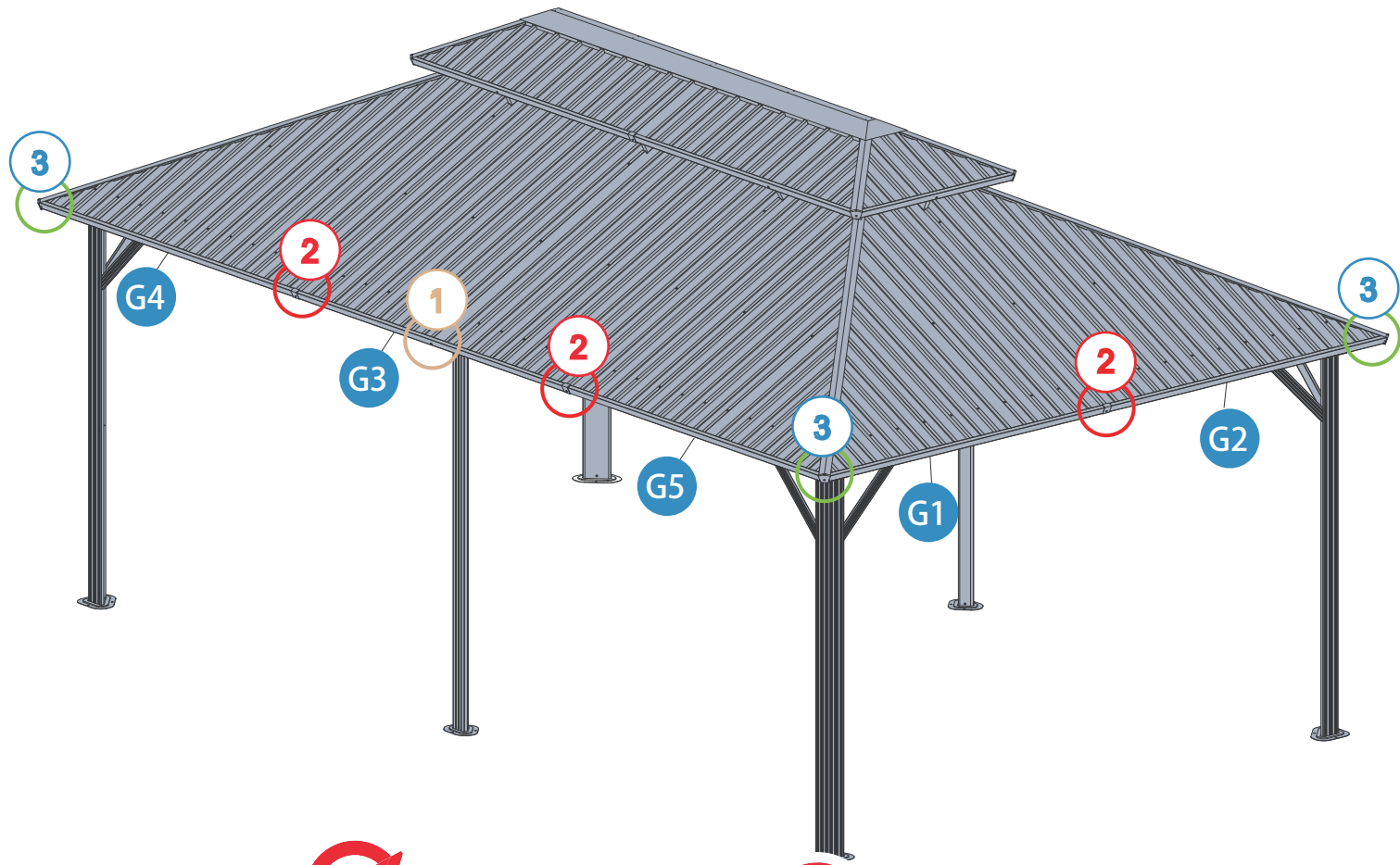

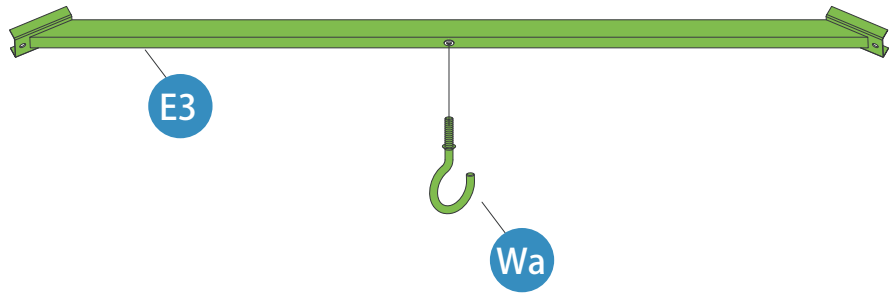
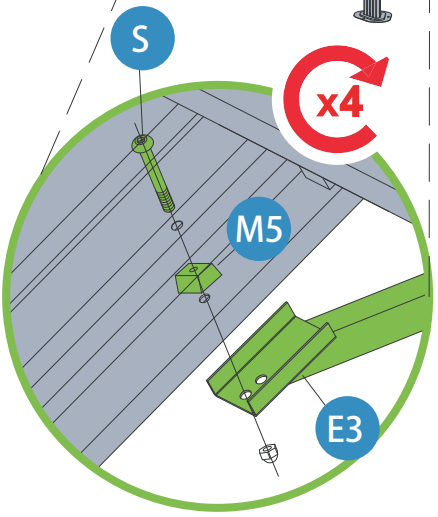
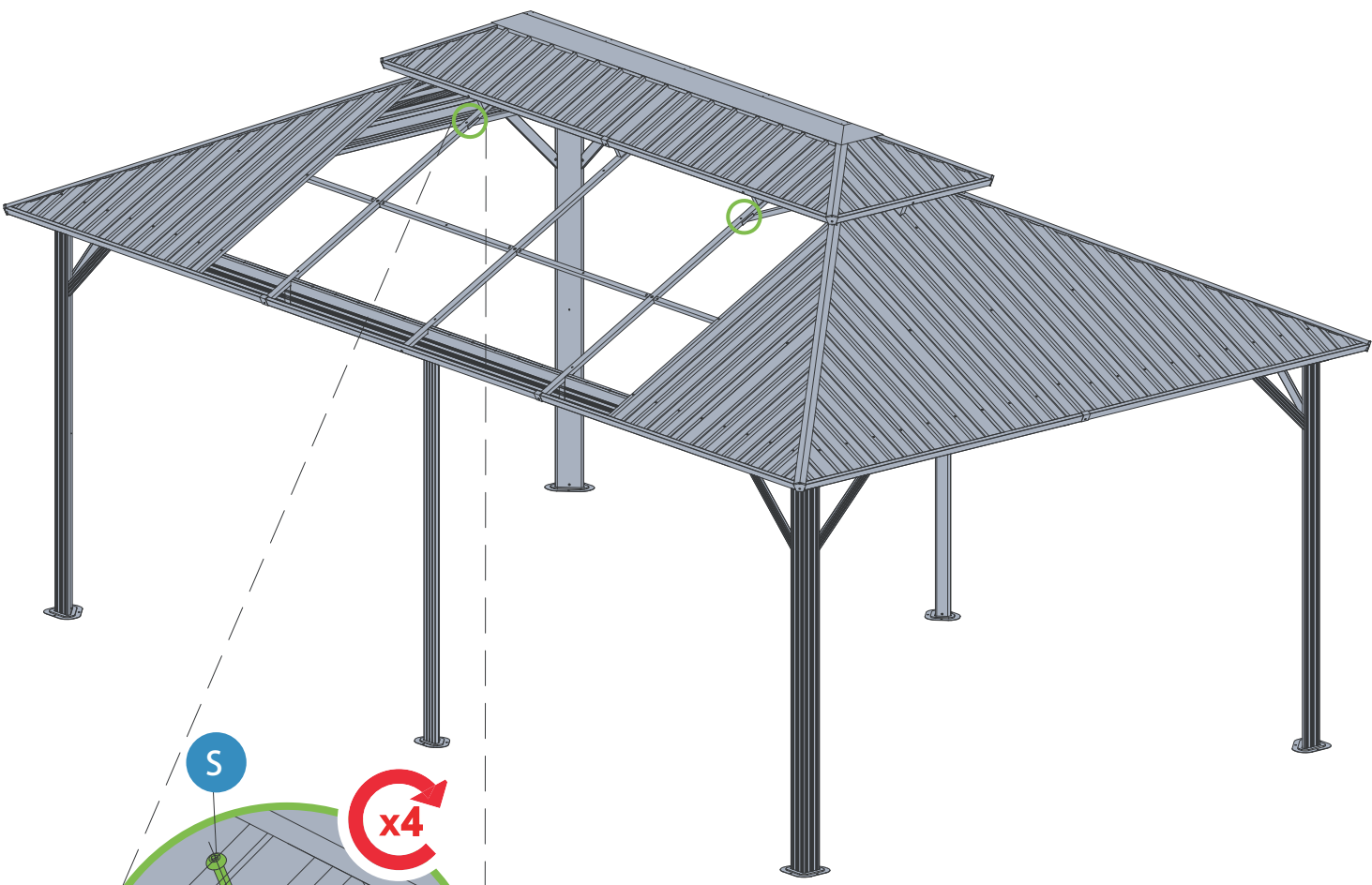
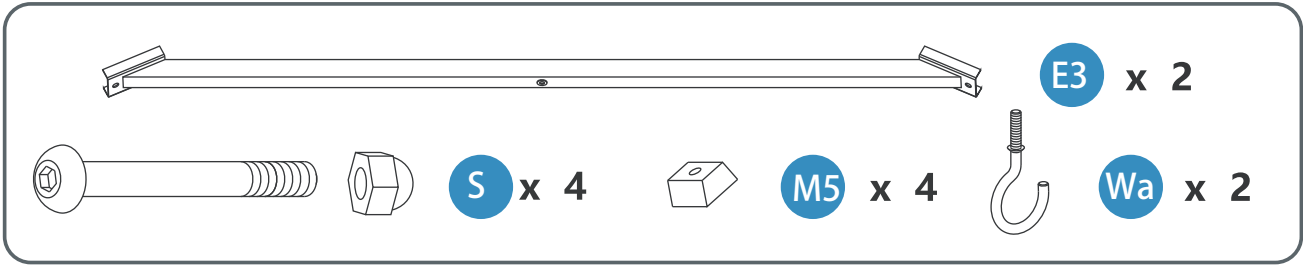

R1 x 2

M2 x 4

R2 x 2

V x 4

R3 x 2

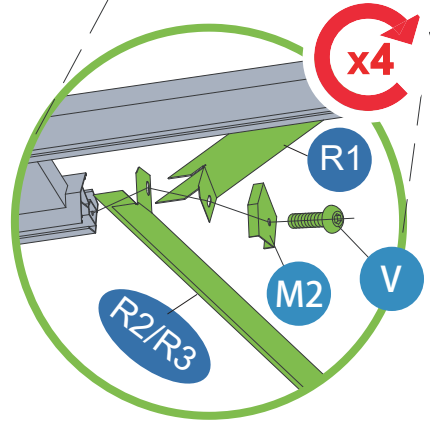
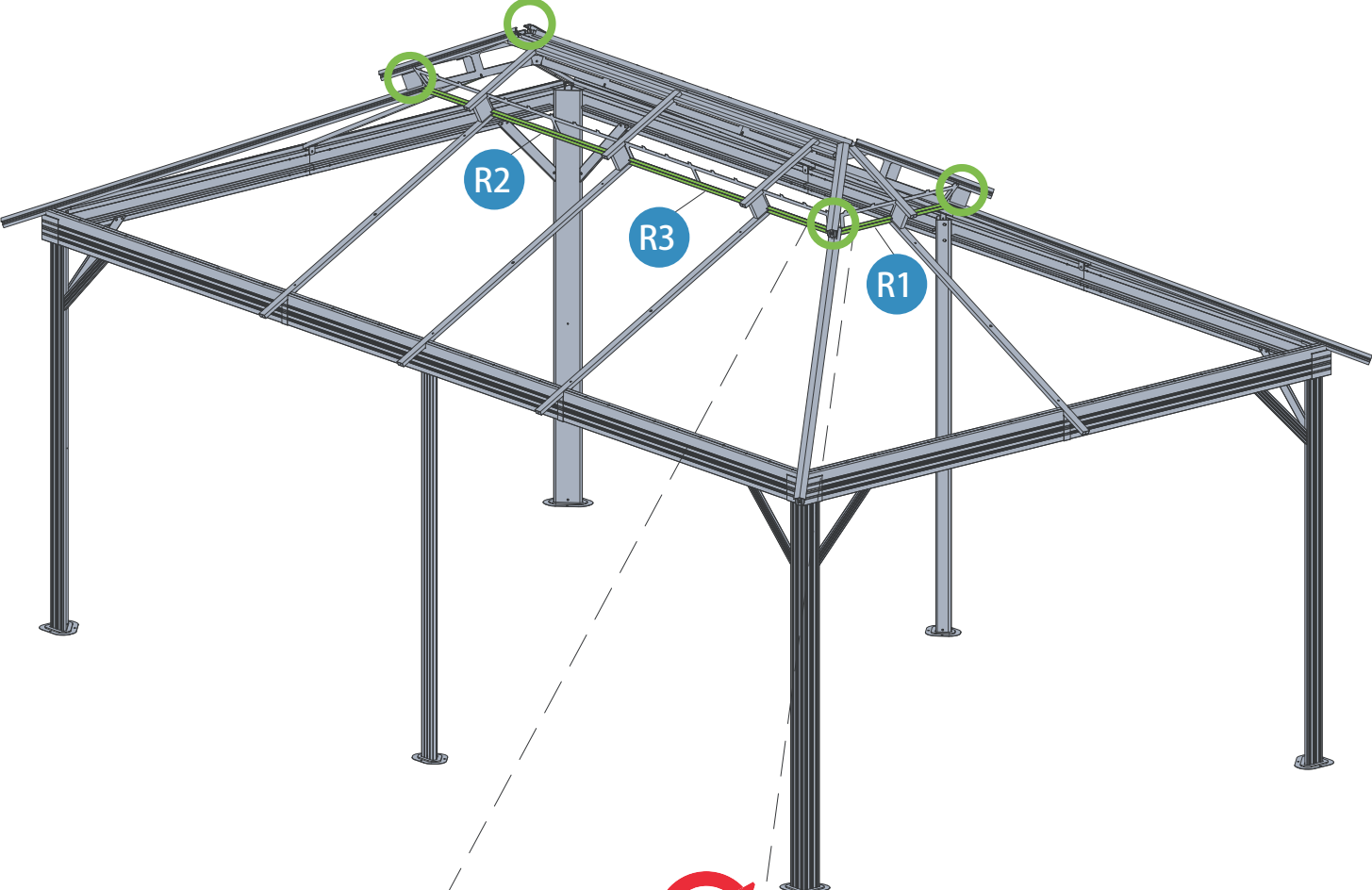
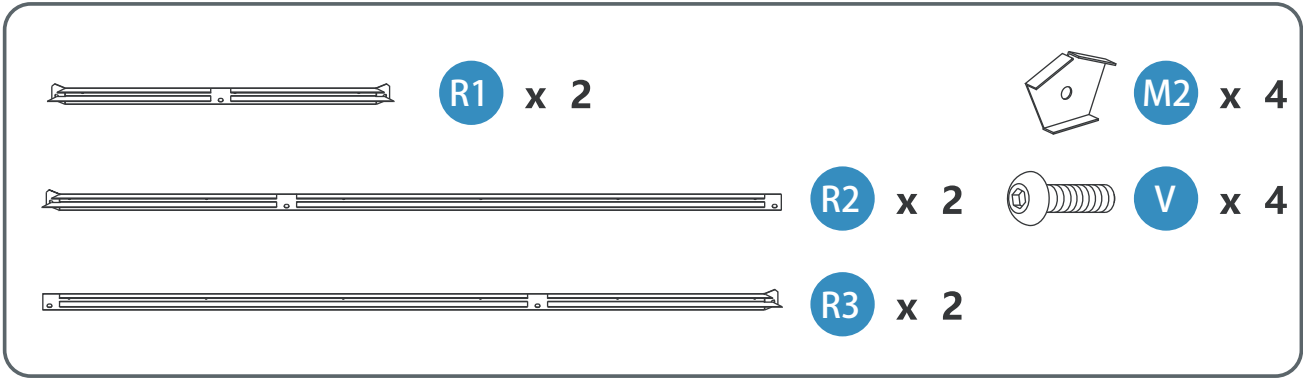

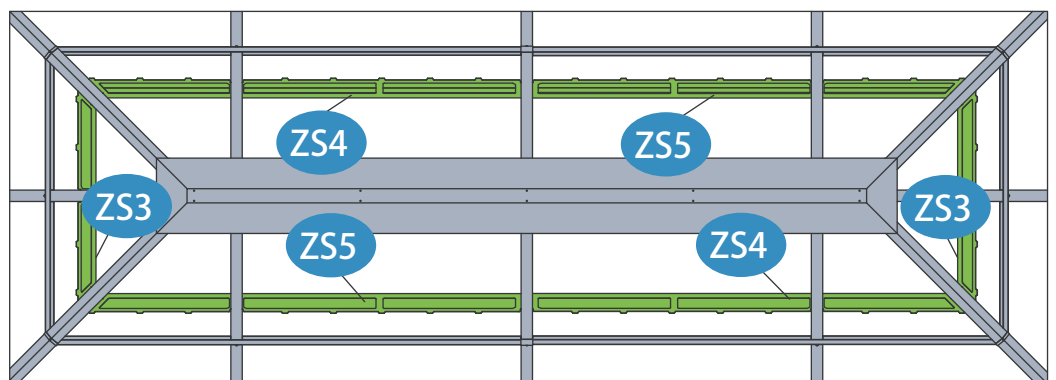
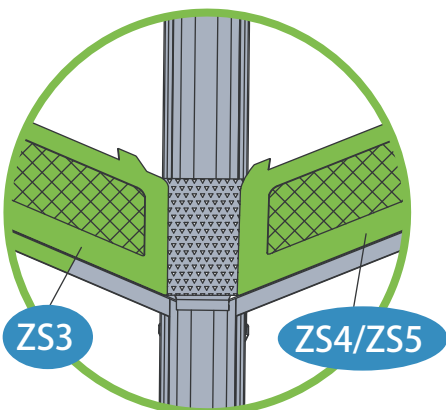
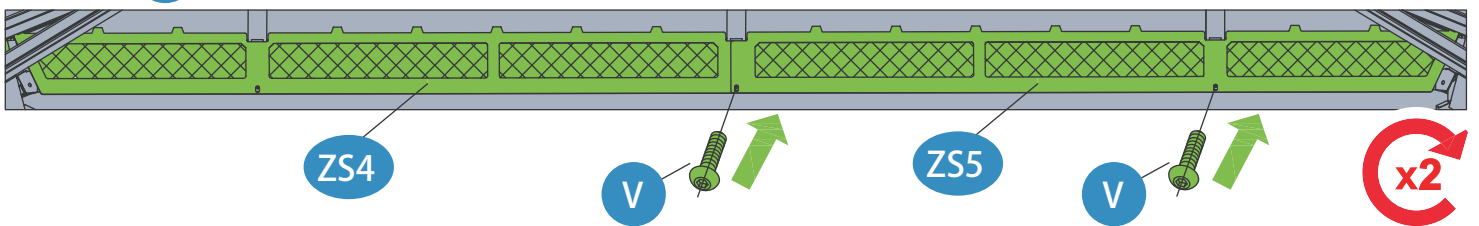
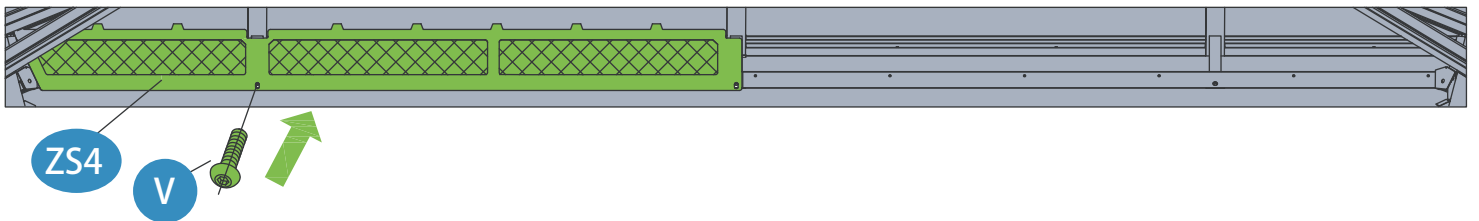
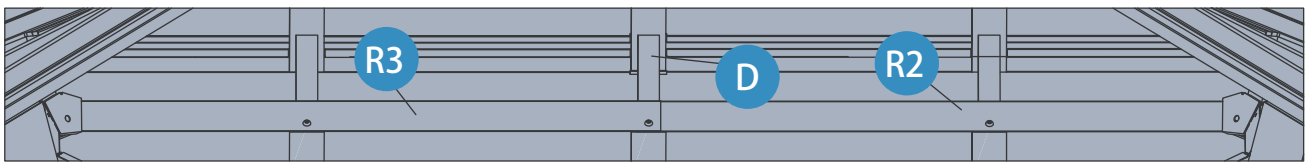
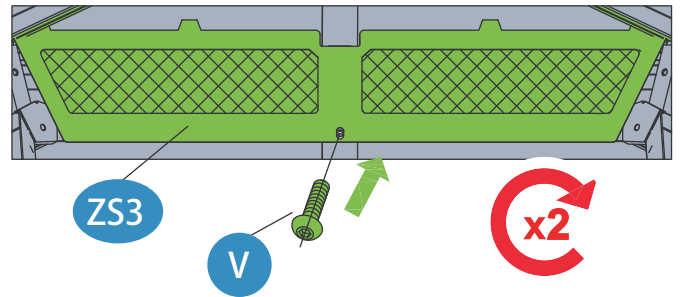
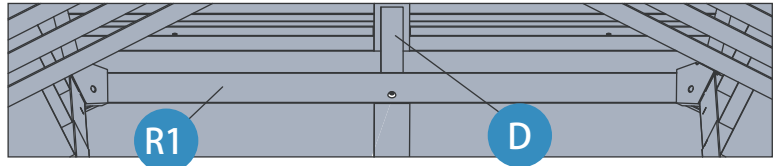
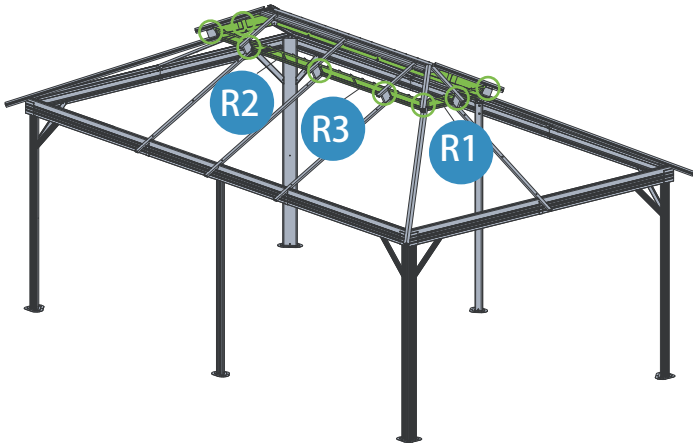
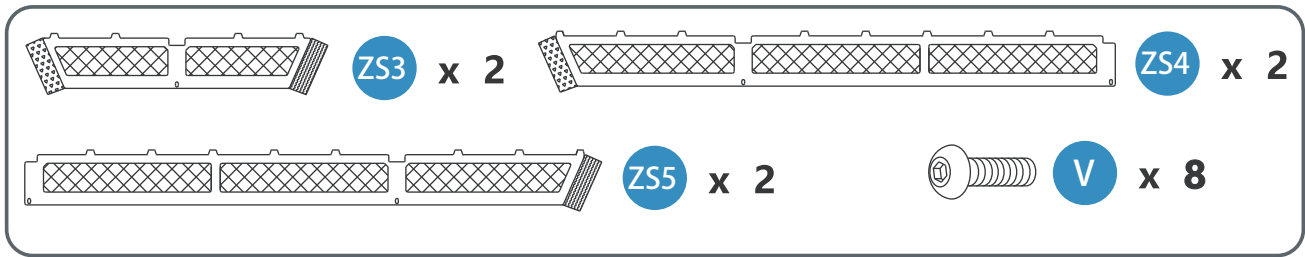

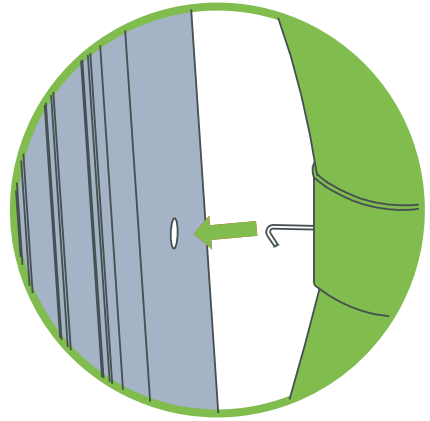
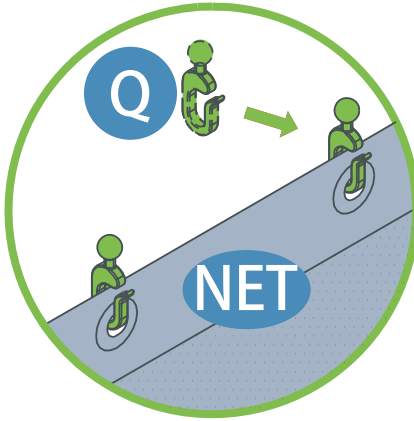
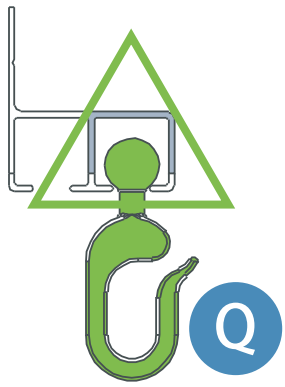

Pay attention to the sidewall netting's installation position.

Hang the hook attached to the netting on Part A/A1.

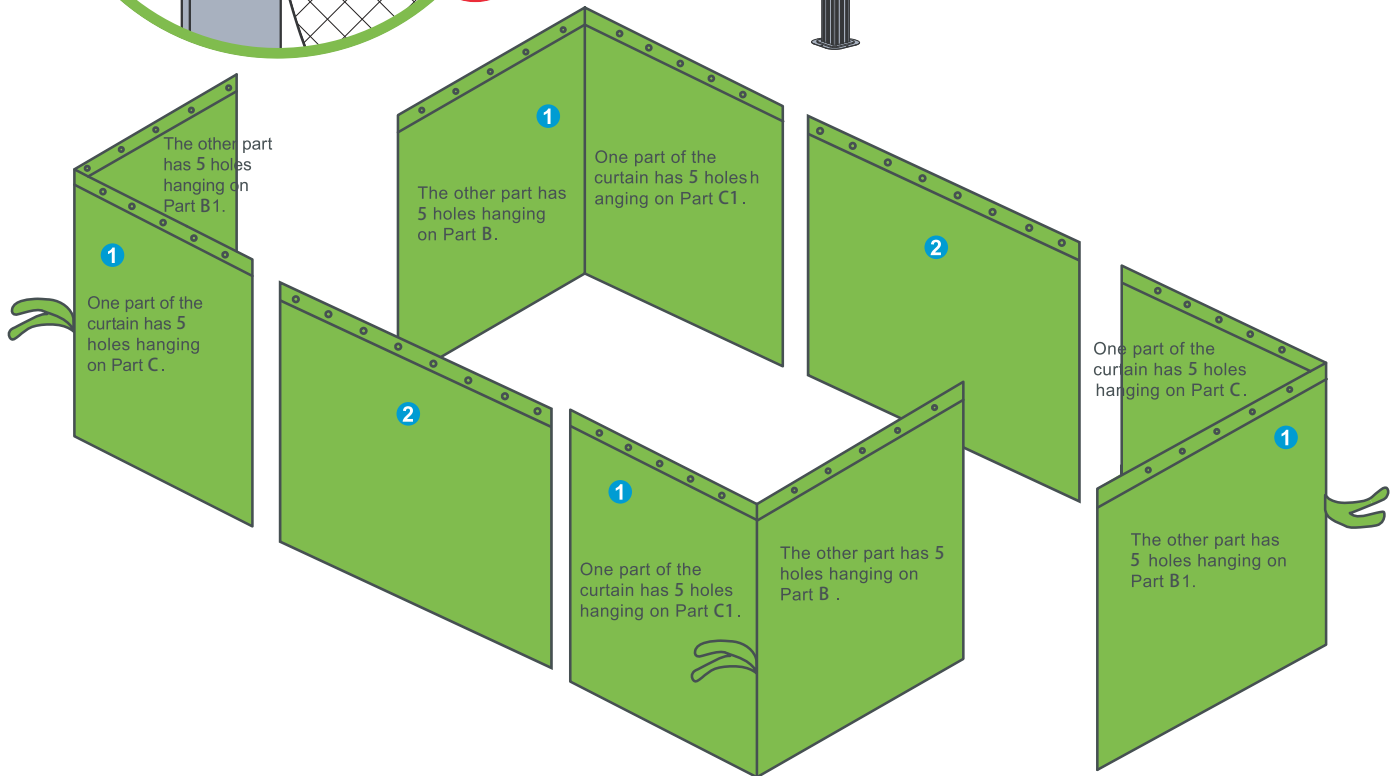
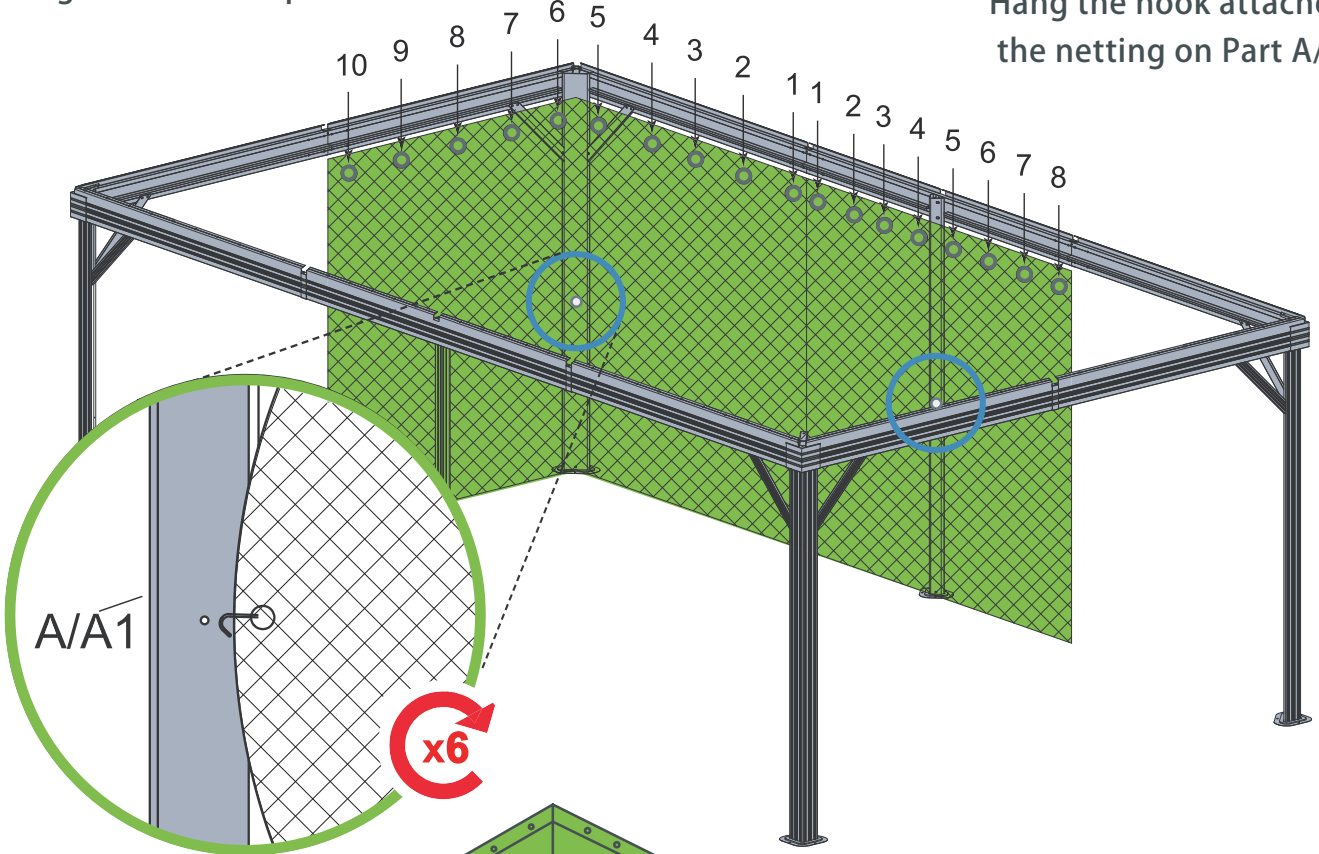

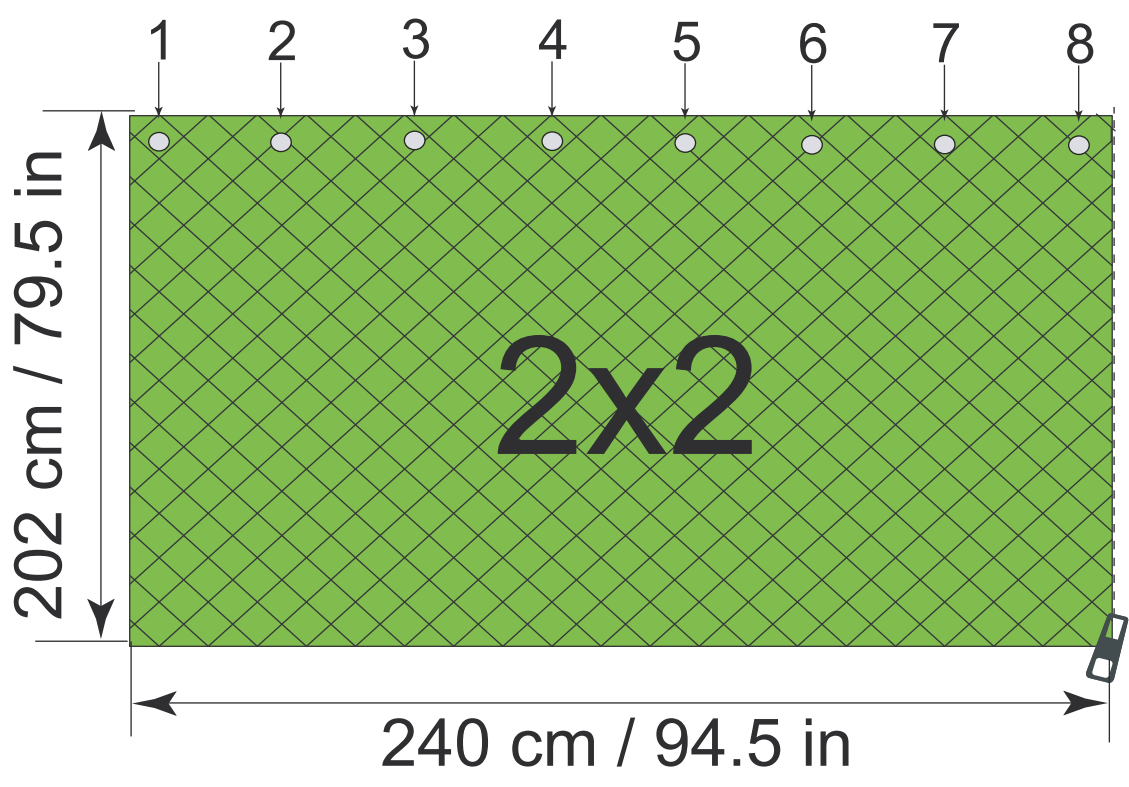
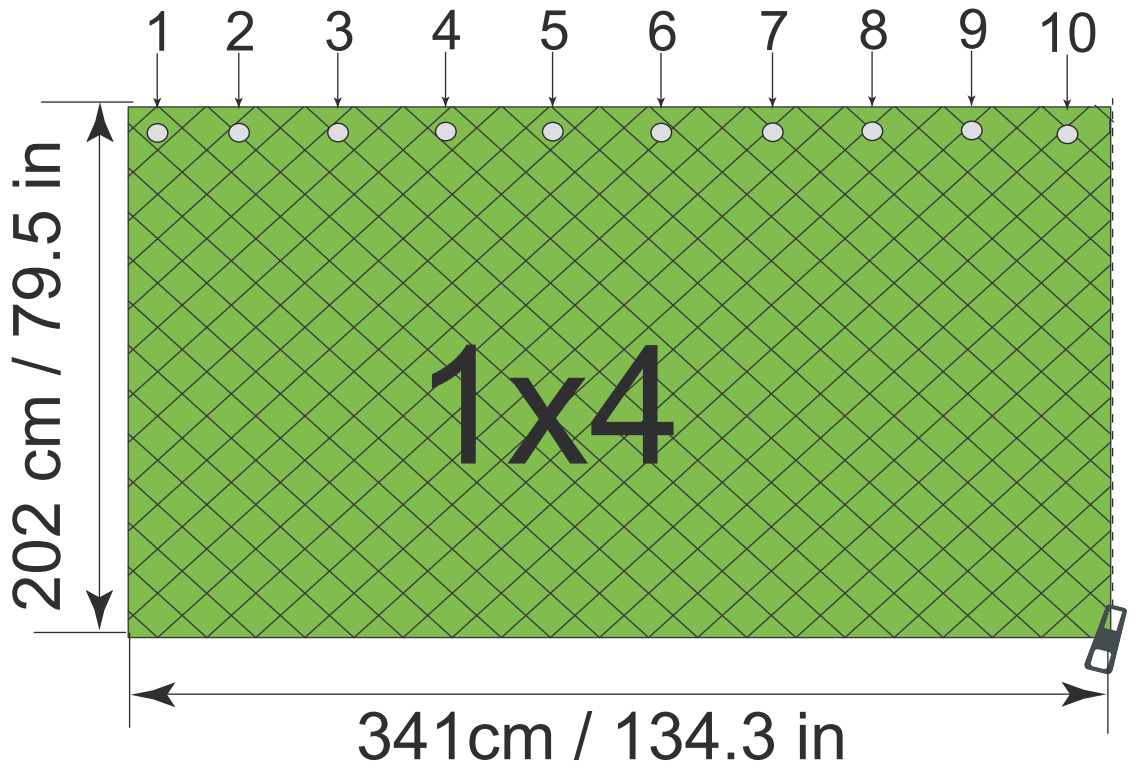

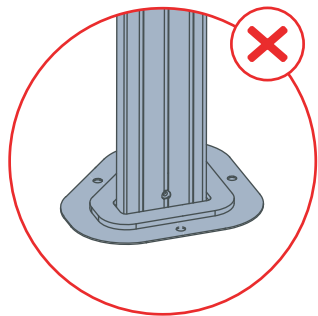
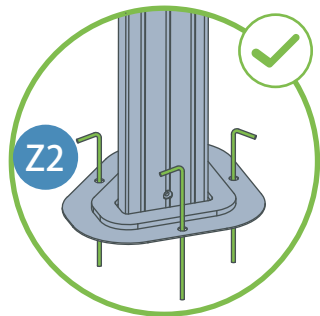
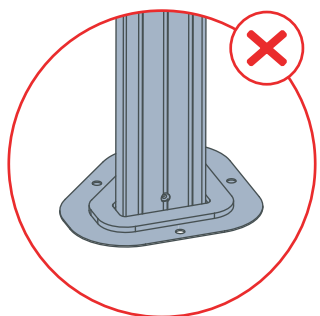
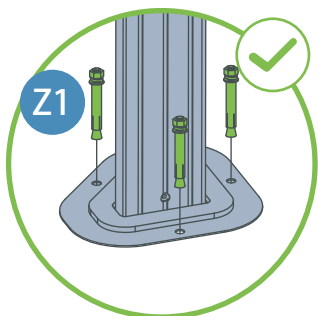
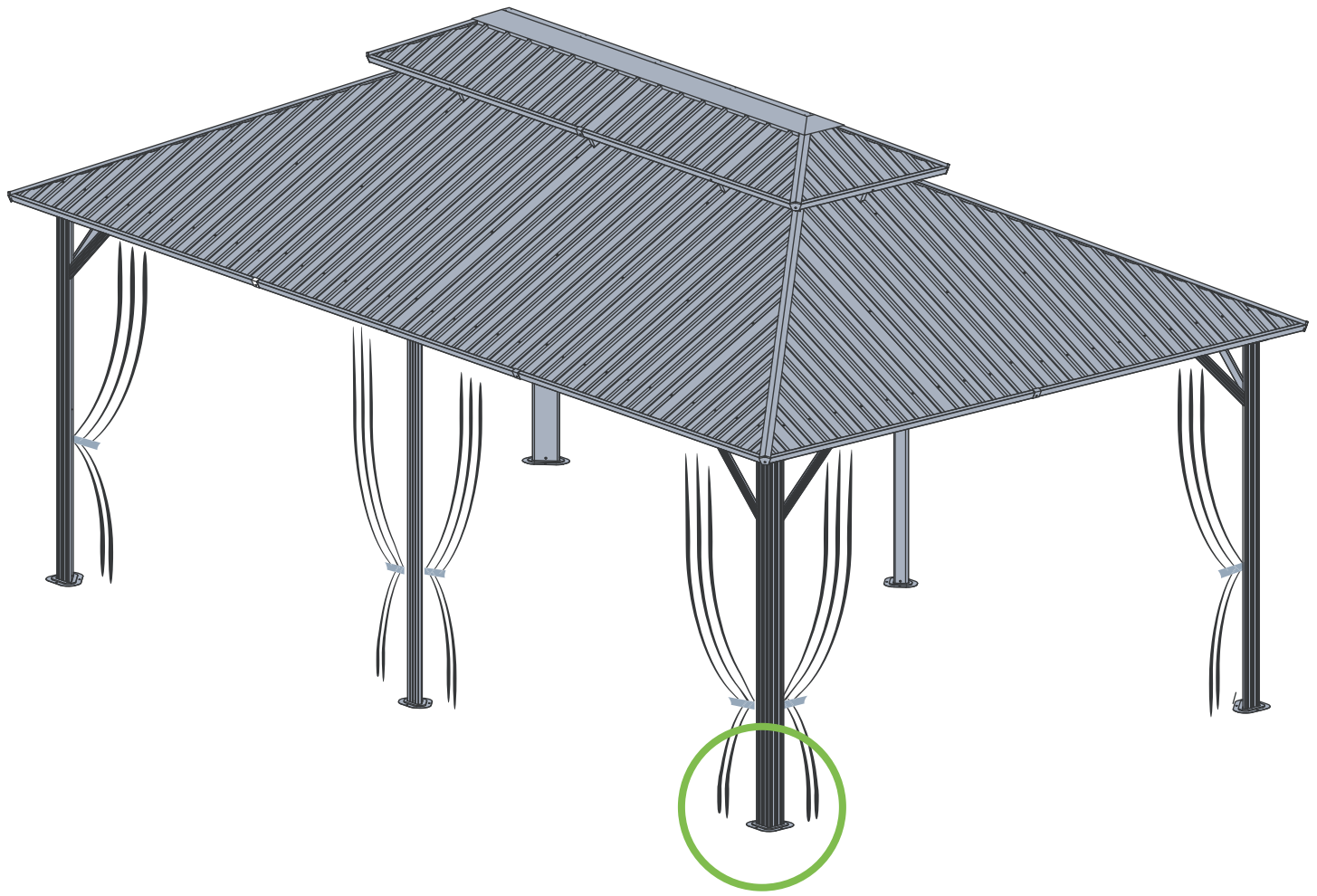
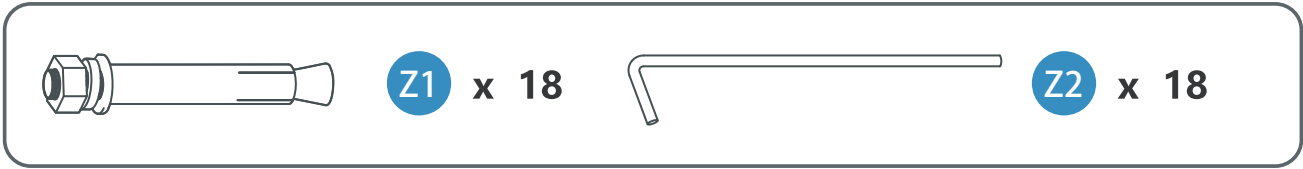

Cement surfaces

Grassy surfaces

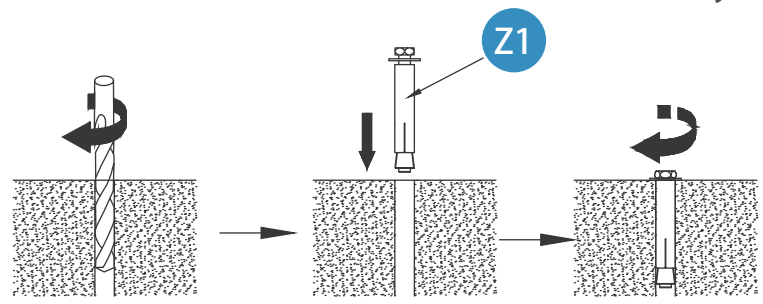

To improve wind resistance, be sure to complete this installation step. If expansion screws or ground nails are not installed, strong winds may topple the gazebo. Expansion screws are essential for stability on cement surface, and ground nails are for grassy surfaces. All are included in the accessories package.