

CAUTION

- Before use, please read this instruction carefully! This product does not convert voltage (AC-AC), to avoid possible damage to your device or other safety hazards, please make sure the power outlet you intend to use has the proper voltage to run your device before using this adapter.
- Each country has its own regulations regarding the use of travel adapters, please check in each country before use.
- No grounding: This product is for use with unearthed or double insulated appliances only.
- Indoor use only.



CAUTION
Misuse can lead to electrical shock.

Verbatim Limited Warranty Terms

Verbatim warrants this product to be free from defects in material and workmanship for a period of 2 years from date of purchase. This warranty excludes batteries. If this product is found to be defective within the warranty period, it will be replaced at no cost to you. You may return it with your original cash register receipt to the place of purchase or contact Verbatim. Product replacement is your sole remedy under this warranty, and this warranty does not apply to normal wear or to damage resulting from abnormal use, misuse, abuse, neglect or accident, or to any incompatibility or poor performance due to the specific computer software or hardware used.

VERBATIM WILL NOT BE LIABLE FOR ANY INCIDENTAL, CONSEQUENTIAL OR SPECIAL DAMAGES, HOWEVER CAUSED, FOR BREACH OF WARRANTIES OR OTHERWISE.

This warranty gives you specific legal rights and you may also have other rights which vary from state to state or country to country.

Note

Verbatim may at any time revise the content of this user guide without further notice.

Rights

Copyright © 2023 Verbatim. No part of this document may be reproduced in any form or by any means, for any purpose, without the express written permission of Verbatim. All rights reserved.

All other brands and product names referenced herein are property of their respective owners.

CE Declaration

Complies with the requirements set out in the Council Directive on the Approximation of the Laws of the Member States relating to Electromagnetic Compatibility (2014/30/EC), Low Voltage Directive (2014/35/EC) and General Product Safety Directive (2001/95/EC).

This declaration applies to all specimens manufactured identical to the model submitted for testing/evaluation.

EN 55032:2015+A11:2020+A1:2020

EN 55035:2017+A11:2020

EN IEC 61000-3-2:2019+A1:2021

EN 61000-3-3:2013+A1:2019+A2:2021

EN IEC 62368-1:2020+A11:2020

RoHS Compliance

This product is in compliance with Directives 2011/65/EU and 2015/683 of the European Parliament and of the Council of 18th December 2006, on the restriction of the use of hazardous substances in electrical and electronic equipment (RoHS) and its amendments.

Substances of Very High Concern (SVHC) including 235 substances contained in Candidate List of June 14th 2023 are not present in this product range above permitted levels.

WEEE Notice

The Directive on Waste Electrical and Electronic Equipment (WEEE), which entered into force as European law on 13th February 2003, resulted in a major change in the treatment of electrical equipment at end-of-life.

The WEEE logo (shown at the left) on the product or on its box indicates that this product must not be disposed of or dumped with your other household waste. For more information about electronic and electrical waste equipment disposal, recovery, and collection points, please contact your local municipal household waste disposal service or shop from where you purchased the equipment.

FCC Compliance

This equipment has been tested and found to comply with the limits for a Class B digital device, pursuant to Part 15 of the FCC Rules. These limits are designed to provide reasonable protection against harmful interference in a residential installation. This equipment generates, uses and can radiate radio frequency energy and, if not installed and used in accordance with the instructions, may cause harmful interference to radio communications. However, there is no guarantee that interference will not occur in a particular installation.

If this equipment does harmful interference to radio or television reception, which can be determined by turning the equipment off and on, the user is encouraged to try to correct the interference by one or more of the following measures:

- Reorient or relocate the receiving antenna.
- Increase the separation between the equipment and receiver.
- Connect the equipment into an outlet on a circuit different from that to which the receiver is connected.
- Consult the dealer or an experienced radio/TV technician for help.

Triman (Only for France)

The product and packaging materials are recyclable, dispose of it separately for better waste treatment. The Triman logo is valid in France only.



Technical Support and Documentation

🇺🇸 To download the user manual, access frequently asked questions or contact the Verbatim support team, please go to – www.verbatim.com/support.

🇫🇷 Pour télécharger le manuel d'utilisation, accéder aux questions fréquemment posées ou contacter l'équipe d'assistance Verbatim, veuillez vous rendre sur – www.verbatim.com/support.

🇩🇪 Um die Betriebsanleitung herunterzuladen, auf häufig gestellte Fragen zuzugreifen oder das Verbatim-Supportteam zu kontaktieren, gehen Sie bitte auf – www.verbatim.com/support.

🇳🇱 Om de gebruikershandleiding te downloaden, veegestelde vragen te raadplegen of contact op te nemen met het Verbatim-ondersteuningsteam, gaat u naar – www.verbatim.com/support.

🇮🇹 Per scaricare il manuale utente, vedere le risposte alle domande più frequenti o contattare il team di Assistenza Verbatim, visita la pagina – www.verbatim.com/support.

🇪🇸 Para descargar el manual de usuario, acceder a las preguntas más frecuentes o ponerse en contacto con el equipo de asistencia de Verbatim, visite – www.verbatim.com/support.

🇵🇹 Para descarregar o manual do utilizador, aceder às perguntas mais frequentes ou contactar a equipa de apoio Verbatim, por favor vá a – www.verbatim.com/support.

🇵🇱 Aby pobrać instrukcję obsługi, uzyskać odpowiedzi na często zadawane pytania lub skontaktować się z zespołem pomocy technicznej, proszę przejść na stronę www.verbatim.com/support.

🇷🇺 Чтобы загрузить руководство пользователя, ознакомиться с часто задаваемыми вопросами или связаться со службой поддержки Verbatim, перейдите по адресу – www.verbatim.com/support.

🇨🇿 Chcete-li si stáhnout uživatelskou příručku, získat přístup k často kladeným otázkám nebo kontaktovat tým podpory společnosti Verbatim, přejděte na stránku – www.verbatim.com/support.

🇭🇺 A felhasználói kézikönyv letöltéséhez, a gyakran ismételt kérdések eléréséhez vagy a Verbatim ügyfélszolgálatával való kapcsolatfelvételhez kérjük, látogasson el a www.verbatim.com/support weboldalra.

🇸🇪 🇩🇪 🇩🇪 Za preuzimanje korisničkog priručnika, pristupite često postavljanim pitanjima ili kontaktirajte Verbatim tim za podršku, idite na – www.verbatim.com/support.

🇸🇰 Ak si chcete stiahnuť používateľskú príručku, získajte prístup k často kladeným otázkam alebo kontaktovať tím podpory spoločnosti Verbatim, prejdite na – www.verbatim.com/support.

🇷🇺 Pentru a descărca manualul de utilizare, pentru a accesa întrebările frecvente sau pentru a contacta echipa de asistență Verbatim, vă rugăm să accesați – www.verbatim.com/support.

🇹🇷 Kullanım kılavuzunu indirmek, sık sorulan sorulara erişmek veya Verbatim destek ekibiyle iletişime geçmek için lütfen şu adrese gidin – www.verbatim.com/support.

🇨🇳 關於常見問題的解答可以下載產品使用手冊或聯繫 Verbatim 的支援團隊，請登入 – www.verbatim.com/support.

🇨🇳 关于常见问题的解答可以下载产品使用手册或联系 Verbatim 的支援团队，请登入 – www.verbatim.com/support.

🇰🇷 사용 설명서 다운로드, 자주 묻는 질문 확인 또는 버batim 지원팀에 직접 문의하시려면 www.verbatim.com/support 로 접속하십시오.

🇯🇵 ユーザーマニュアルのダウンロード、よくあるご質問、サポート情報については、www.verbatim.com/support をご参照ください。

www.verbatim.com

- EUROPE/MIDDLE EAST/AFRICA: Verbatim GmbH, Düsseldorfer Straße 13, 65760 Eschborn, Germany
- AMERICAS: USA Verbatim Americas LLC, Charlotte, NC 28262
- AUSTRALIA/ NEW ZEALAND: Verbatim Australia Pty Ltd, Unit 6, 450 Princes Highway, Noble Park, Victoria, 3174 Australia
- ASIA: Verbatim Hong Kong Ltd, Unit 1101-02, 11/F, Energy Plaza, No. 92 Granville Road, Tsimshatsui East, Kowloon, Hong Kong
- Japan: Verbatim Japan LTD., 2-15-4 Kandatsukasamachi, Chiyoda-ku, Tokyo 101-0048, Japan



2309



QUICK START GUIDE

Verbatim GaN Charger 100W
with 2 x USB-C® PD 100 W /
1 x USB-C® PD 65 W /
1 x USB-A QC 3.0
(EU/UK/US)
GNC-100

How it works

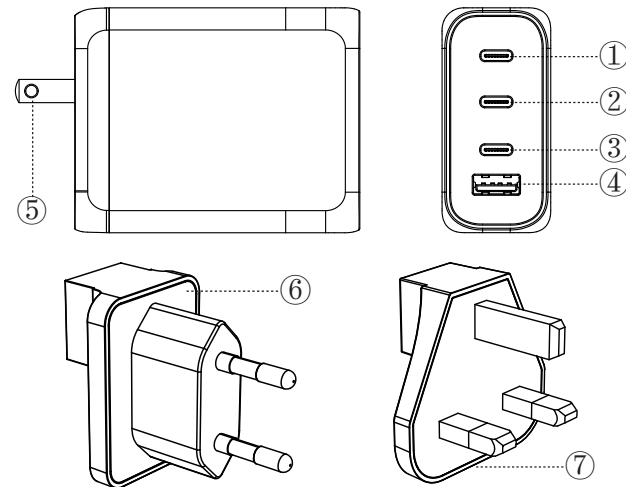

1. USB-C1 PD 3.0
2. USB-C2 PD 3.0
3. USB-C3 PD 3.0
4. USB-A QC 3.0
5. Integrated US plug
6. EU plug
7. UK plug

A) To use the US Plug:
Please pull down the Plug until it clicks. It points into a horizontal direction.

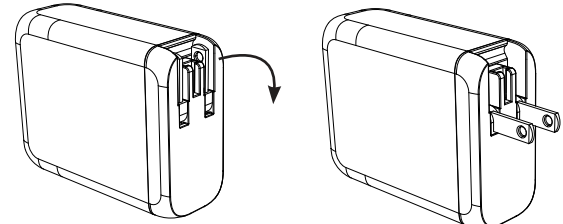

To close the US Plug, please pull it upwards until it points in a vertical direction again.

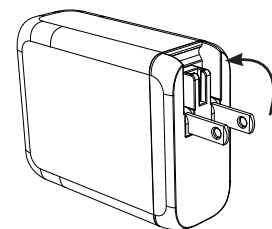

B) To use the EU Plug:
Please (be sure the US Plug is closed)

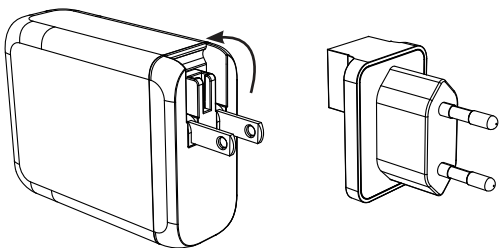

Put the EU Plug with the connector on top, onto the (closed) US Plug and push it down until it clicks.

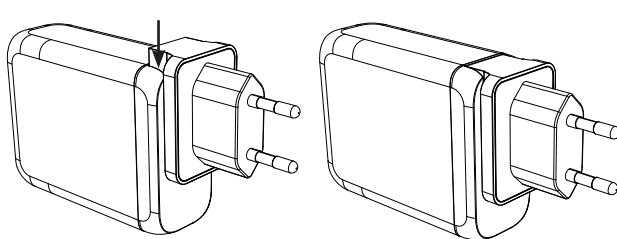

To remove the EU Plug please push it upwards.

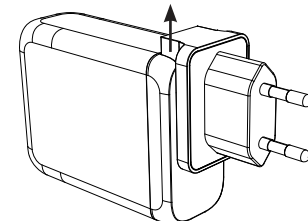

C) To use UK Plug

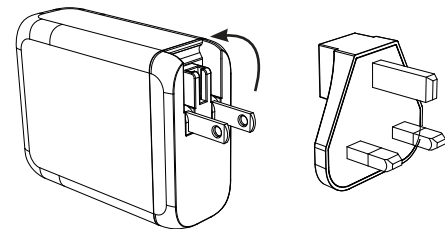

Put the UK Plug with the connector on top, onto the (closed) US Plug and push it down until it clicks.

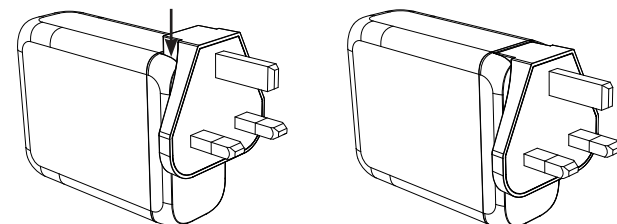

To remove the UK Plug please push it upwards.

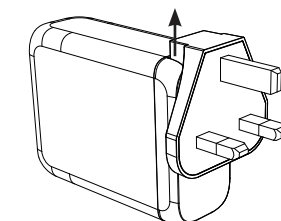

Connection

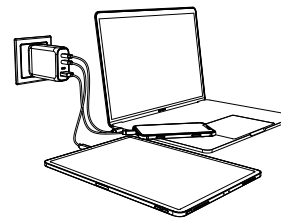

Now you can plug the GaN Charger into the wall socket and plug in your cables and devices.

Safety Instructions

- Protect the product from dirt, moisture and overheating and use it in dry rooms only.
- Do not drop the product and do not expose it to any major shocks.
- Do not operate the product outside the power limits given in the specifications.
- Use the product only for the intended purpose.
- As with all electrical products, this device should be kept out of the reach of children.
- Do not use the product in the immediate vicinity of heaters, other heat sources or in direct sunlight.
- Keep the packaging in a safe place for future reference. It contains important information.
- The product is intended only for use inside buildings.
- Only use the article under moderate climatic conditions (0°C-35°C, humidity below 80%).
- Do not use the product in areas in which electronic products are not permitted.
- Do not use the product in a damp environment and avoid splashing water.

Operation Warnings

Risk of electric shock

- Do not open the device or continue to operate it if it becomes damaged.
- Before connecting a device, check whether it is suitable for the voltage/mains frequency available in the country.
- Do not operate the product continuously, as it is not designed for this.
- Do not continue to operate the product if it is visibly damaged.
- The product is not designed for operation with other adapters.

Care and maintenance

- Disconnect the device from the mains before cleaning and during prolonged periods of non-use.
- Only operate the product from a socket that has been approved for the device. Plug devices directly into the adapter and the adapter directly into the socket.
- To disconnect please remove all devices from the adapter before removing the adapter from the socket.

Specifications

- Input Voltage: AC 100-240~ 50/60Hz 1.8A max.
- USB-C1 PD 3.0 Output: 3.3-21 V = 5 A, 5 V = 3 A, 9 V = 3 A, 12 V = 3 A, 15V = 3 A, 20 V = 5 A (100 W max.)
- USB-C2 PD 3.0 Output: 3.3-21 V = 5 A, 5 V = 3 A, 9 V = 3 A, 12 V = 3 A, 15 V=3 A, 20 V = 5 A (100 W max.)
- USB-C3 PD 3.0 Output: 3.3-11 V = 5 A, 5 V = 3 A, 9 V = 3 A, 12 V = 3 A, 15 V=3 A, 20 V = 3.25 A (65 W max.)
- USB-A QC 3.0 Output: 4.5 V = 5 A, 5 V = 4.5 A, 5 V = 3 A, 9 V = 3 A, 12 V = 2.5 A, 20 V = 1.5 A (30 W max.)
- USB-C1+USB-C2/C3: 65 W+35 W
- USB-C1/C2+USB-A: 65 W+30 W
- USB-C2+USB-C3: 65 W+35 W
- USB-C3+USB-A: 15 W(5V = 3A)
- USB-C1+USB-C2+USB-C3: 45 W+35 W+20 W
- USB-C1+USB-C2+USB-A: 45 W+35 W+18 W
- USB-C1/C2+USB-C3+USB-A: 65 W+15 W (USB-C3+USB-A)
- USB-C1+USB-C2+USB-C3+USB-A : 45 W+35 W+15 W (USB-C3+USB-A)
- Total Output: 100W max
- Output Short Circuit Protect: on short circuit protection situation, will stop charging to protect devices.
- Over-voltage protection
- Over-current protection
- Over-temperature protection
- Material: Plastic Housing: PC Fireproof material
- Dimensions (W x H x D): 77.5mm x 61.1mm x 29.3mm
- Weight: 226 grams