



Liebert[®] GXE UPS 1-3kVA

Installer/User Guide

230V Input, 230V Output

The information contained in this document is subject to change without notice and may not be suitable for all applications. While every precaution has been taken to ensure the accuracy and completeness of this document, Vertiv assumes no responsibility and disclaims all liability for damages result from use of this information or for any errors or omissions.

Refer to local regulations and building codes relating to the application, installation, and operation of this product. The consulting engineer, installer, and/or end user is responsible for compliance with all applicable laws and regulations relation to the application, installation, and operation of this product.

The products covered by this instruction manual are manufactured and/or sold by Vertiv. This document is the property of Vertiv and contains confidential and proprietary information owned by Vertiv. Any copying, use, or disclosure of it without the written permission of Vertiv is strictly prohibited.

Names of companies and products are trademarks or registered trademarks of the respective companies. Any questions regarding usage of trademark names should be directed to the original manufacturer.

Technical Support Site

If you encounter any installation or operational issues with your product, check the pertinent section of this manual to see if the issue can be resolved by following outlined procedures.

Visit <https://www.vertiv.com/en-us/support/> for additional assistance.

TABLE OF CONTENTS

1 Important Safety Instructions	1
2 Product Description	3
2.1 UPS Features and Available Models	3
2.2 Front Panels	3
2.3 Rear Panels	4
2.4 Internal Battery Packs	6
2.5 External Battery Cabinet (EBC)	6
2.6 Major Internal Components and Operating Principle	7
2.7 UPS Operating Modes	8
2.7.1 Normal Mode	8
2.7.2 Bypass Mode	9
2.7.3 Battery Mode	10
2.7.4 ECO Mode	11
2.7.5 Frequency Converter Mode	11
3 Installation	13
3.1 Unpacking and Inspection	14
3.2 Pre-Installation Preparation	14
3.2.1 Installation Clearances	14
3.3 Installing the Tower UPS	14
3.4 Installing the Rack/Tower UPS	15
3.4.1 Tower Installation of the Rack/Tower UPS	15
3.4.2 Rack Installation of the Rack/Tower UPS	16
3.5 Installing the External Battery Cabinets (EBCs)	16
3.5.1 Branch Circuit Breaker	18
3.6 Setup the UPS	19
3.6.1 Input connection	19
3.6.2 Output connection	19
3.7 Communication Connections	19
3.7.1 Connecting Liebert® IntelliSlot™ Communication Card	20
3.7.2 Connecting a USB Cable	20
3.7.3 Connecting to the (Emergency Power Off) EPO Port	20
3.8 UPS Management Software	21
4 Operating the UPS	23
4.1 Starting Up the UPS	23
4.2 Mute the Audible Alarm	23
4.3 Transferring to Battery Mode	23
4.4 Transferring from Normal to Bypass Mode	23

- 4.5 Transferring from Bypass to Normal Mode 23
- 4.6 Transferring from Normal to Standby Mode 24
- 4.7 Shutting Down the UPS Completely 24
- 4.8 Emergency Power Off (EPO) 24
- 5 Operation and Display Panel 25**
- 5.1 Button Operation 25
- 5.2 LCD Display Wording 27
- 5.3 UPS Setting 28
- 5.4 Operating Mode Description 30
- 5.5 Fault Reference Code 31
- 5.6 Warning Indicator 32
- 5.7 Communication 33
- 6 Maintenance 35**
- 6.1 Replacing Batteries 35
- 6.2 Charging Batteries 37
- 6.3 Checking UPS Operation 37
- 6.4 Cleaning the UPS 37
- 6.5 Storage 38
- 6.6 Firmware Updates 38
- 7 Troubleshooting 39**
- 8 Specifications 41**
- 8.1 Battery Run Times 47
- Appendices A**
- Appendix A: Technical Support and Contacts A
- Appendix B: Open Source Software Legal Notices C

1 Important Safety Instructions

IMPORTANT! This manual contains important safety instructions that must be followed during the installation and maintenance of the UPS and batteries. Read this manual thoroughly and the safety and regulatory information, available at <https://www.vertiv.com/ComplianceRegulatoryInfo>, before attempting to install, connect to supply, or operate this UPS.

Comply with all warnings and operating instructions in this manual strictly. Save this manual and carefully read the following instructions before installing the unit. Do not operate this unit before reading all safety information and operating instructions carefully.

Transportation

- Transport the UPS system in the original packaging to protect against shock and impact.

Preparation

- Condensation may occur, if the UPS system is moved directly from a cold to a warm environment. The UPS system must be absolutely dry before installation. Allow at least 2 hours for the UPS system to adjust to the environment.
- Do not install the UPS system near water or in moist environments.
- Do not install the UPS system where it would be exposed to direct sunlight or near a heater.
- Do not block ventilation holes in the UPS housing.

Installation

- Do not connect appliances or devices, which would overload the UPS system (such as laser printers) to the UPS output sockets.
- Place the cables in such a way that no one can step on or trip over them.
- Connect the UPS system only to an earthed shockproof outlet which must be easily accessible and close to the UPS system.
- Use only VDE-tested, CE-marked mains cable to connect the UPS system to the building wiring shockproof outlet.
- Use only VDE-tested, CE-marked power cables to connect the loads to the UPS system.
- When installing the equipment, ensure that the sum of the leakage current of the UPS and the connected devices does not exceed 3.5 mA.

Operation

- Do not disconnect the mains cable on the UPS system or the building wiring shockproof outlet during operations since this would cancel the protective earthing of the UPS system and of all connected loads.
- The UPS system has internal power source (batteries). The UPS output sockets or output terminal blocks may be electrically live even if the UPS system is not connected to the building wiring outlet.
- In order to fully disconnect the UPS system, first press the **OFF/Enter** button to disconnect the mains.
- Prevent fluids and foreign objects from entering the UPS system.

Maintenance, Service, and Faults

- The UPS system operates at hazardous voltages. Hence maintenance should be carried out only by qualified maintenance personnel.
- The UPS is categorized under *Protective Class I*.



WARNING! Risk of electric shock.

Even after the unit is disconnected from the main building wired outlet, the components inside the UPS system are still connected to the battery. These components are alive electrically and are dangerous.

- Before carrying out any kind of service and/or maintenance, disconnect the batteries and verify that no current is present and no hazardous voltage exists in the terminals of high energy capacitors such as bus capacitors.
- Only people who are familiar with batteries should replace batteries and supervise operations. Unauthorized individuals must stay away from the batteries.



WARNING! Risk of electric shock.

The battery circuit is not isolated from the input voltage. Hazardous voltages may occur between the battery terminals and the ground. Before touching, verify that no voltage is present.

- Batteries may cause electric shock and have a high short circuit current. Take these precautionary measures when working with batteries:
 - Remove wristwatches, rings, and other metal objects.
 - Use only tools with insulated grips and handles.
- When changing the UPS batteries, install the same number and same type of batteries.
- Do not attempt to dispose of the batteries by burning them. This can cause battery explosion.
- Recycle or dispose of batteries properly in accordance to the local regulations.
- Do not open or damage the batteries. Escaping electrolyte is toxic and can cause injury to the skin and eyes.
- Replace fuses only with the same type and amperage in order to avoid fire hazards.
- Do not dismantle the UPS system.

Output Short Circuit Current

Table 1.1 UPS Models and Power Ratings

Model Number	Maximum Peak for AC mode (I _{peak})	Maximum RMS for AC mode (I _{rms})
GXE3-1000IRT2UXL	20.6 A	4.7 A
GXE3-1000IMT		
GXE3-1500IRT2UXL	27.6 A	5.5 A
GXE3-1500IMT		
GXE3-2000IRT2UXL	27.6 A	5.5 A
GXE3-2000IMT		
GXE3-3000IRT2UXL	37.9 A	7.9 A
GXE3-3000IMT		

2 Product Description

The Vertiv™ Liebert® GXE is a compact, online uninterruptible power system (UPS) that continuously conditions and regulates its output voltage. The Liebert® GXE supplies microcomputers and other sensitive equipment with clean sine wave input power.

Upon generation, AC power is clean and stable. However, during transmission and distribution it is subject to voltage sags, spikes, and complete failure that may interrupt computer operations, causing data loss, and damage equipment.

The Liebert® GXE protects equipment from data loss, and damage equipment. The Liebert® GXE continuously acts as back up electricity source when the mains fail.

2.1 UPS Features and Available Models

The Liebert® GXE includes the following features. **Table 2.1** below , lists the available models and power ratings.

- Enhanced load capacity with an output power factor of 0.9.
- Compact tower only form factor or flexible rack/tower convertible design.
- Best fit for unstable power mains supply via high frequency double conversion topology structure, with high input power factor, wide input voltage range, and output immune to grid interference.
- Operation and display panel with LCD offers simple configuration and control of the UPS.
- ECO power supply mode helps save the maximum amount of energy.

Table 2.1 UPS Models and Power Ratings

Model Number	Nominal Output Power Rating at 230 V Input
GXE3-1000IRT2UXL	1000 VA / 900 W
GXE3-1000IMT	
GXE3-1500IRT2UXL	1500 VA / 1350 W
GXE3-1500IMT	
GXE3-2000IRT2UXL	2000 VA / 1800 W
GXE3-2000IMT	
GXE3-3000IRT2UXL	3000 VA / 2700 W
GXE3-3000IMT	

2.2 Front Panels

The various Liebert® GXE models have the same general appearance. **Figure 2.1** on the next page , shows the front view of the tower UPS and rack/tower UPS.

Figure 2.1 Front View

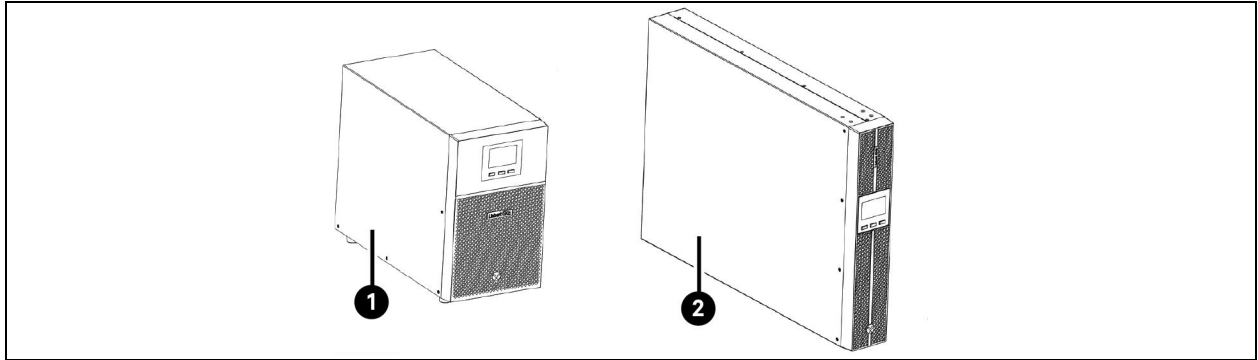

Item	Description
1	Tower UPS
2	Rack/Tower UPS

2.3 Rear Panels

The Figure 2.2 below and Figure 2.3 on the facing page shows the details of the rear panel of each Vertiv™ Liebert® GXE model.

Figure 2.2 Tower UPS — Rear Panel

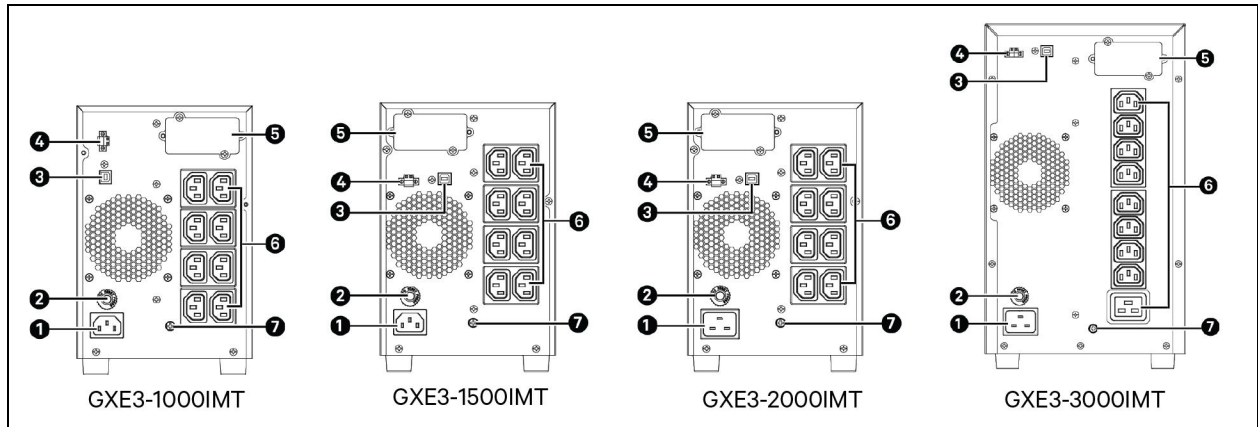

Item	Description
1	AC input
2	Input circuit breaker
3	USB communication port
4	EPO port
5	Vertiv™ Liebert® IntelliSlot™ for optional network management card
6	Output receptacles
7	Grounding screw

Figure 2.3 Rack/Tower UPS — Rear Panel

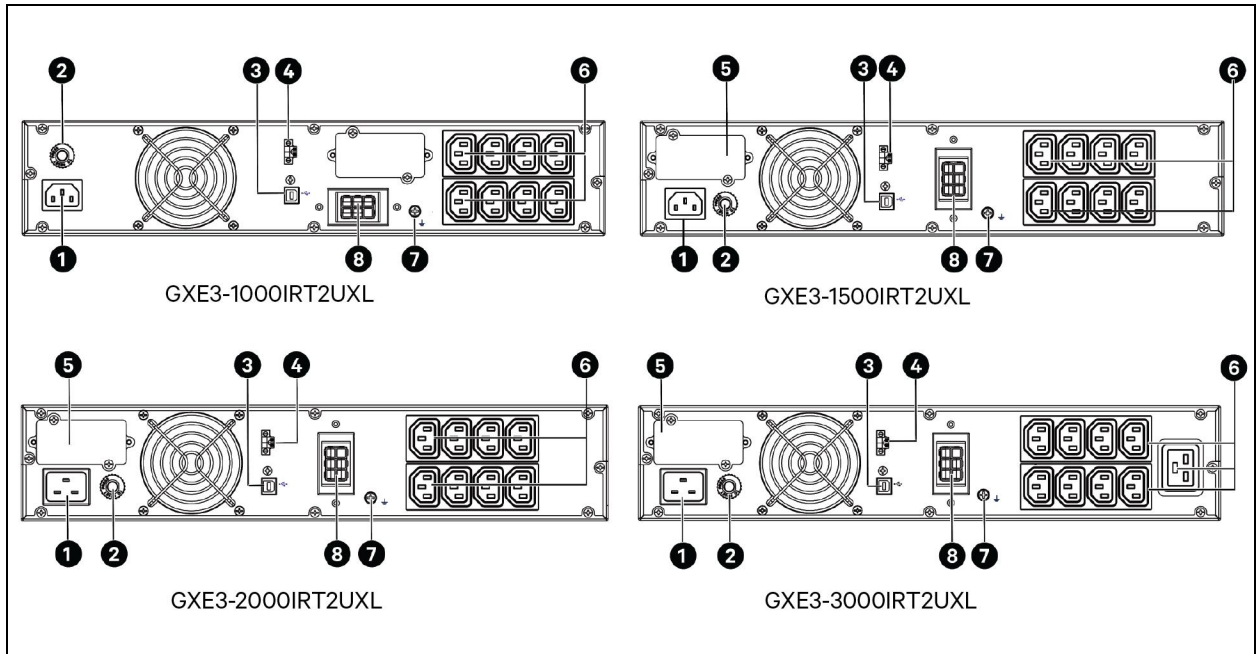

Item	Description
1	AC input
2	Input circuit breaker
3	USB communication port
4	EPO port
5	Vertiv™ Liebert® IntelliSlot™ for optional network management card
6	Output receptacles
7	Grounding screw
8	External battery cabinet (EBC) connector

Figure 2.4 EBC Rear Panel

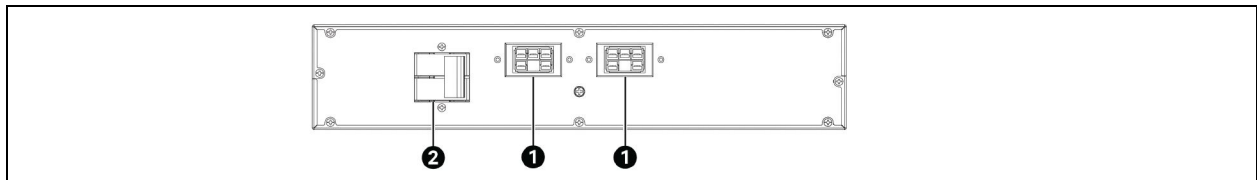

Item	Description
1	EBC connector
2	Isolation breaker

2.4 Internal Battery Packs

An example of the Vertiv™ Liebert® GXE internal battery packs are shown in **Figure 2.5** below and **Figure 2.6** below . These are located behind the access door on the front of the UPS.

Figure 2.5 Battery Pack — 24V, 36V, 48V and 72V

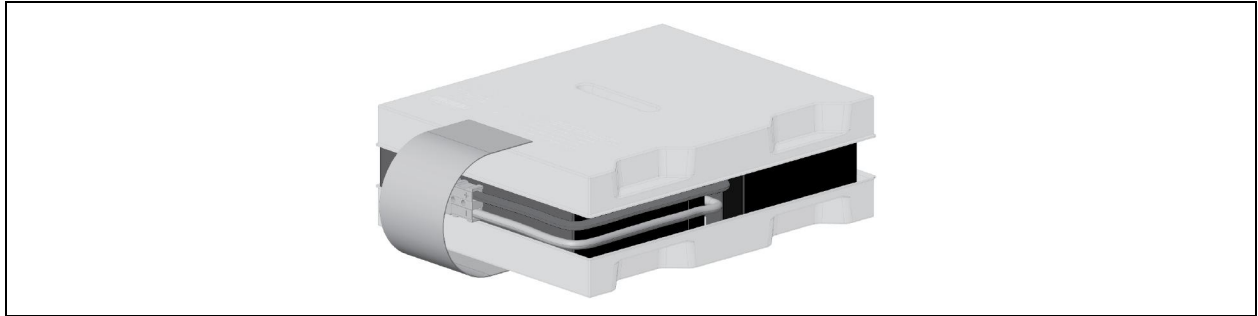
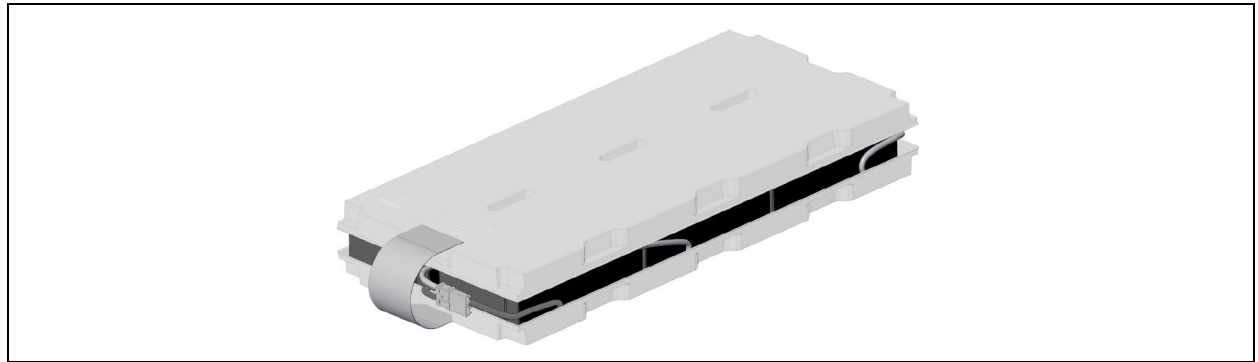

Figure 2.6 Battery Pack for Rack/Tower Model — 72V



2.5 External Battery Cabinet (EBC)

Optional EBCs are available for the rack/tower UPS and includes a single battery cable. Up to 4 EBCs may be connected to the UPS, see **Table 8.3** on page 45 for the EBC specifications. For approximate battery run times with additional EBCs, see [Battery Run Times](#) on page 47 . To connect the cabinets, see [Installing the External Battery Cabinets \(EBCs\)](#) on page 16 .

Figure 2.7 EBC for Rack/Tower UPS

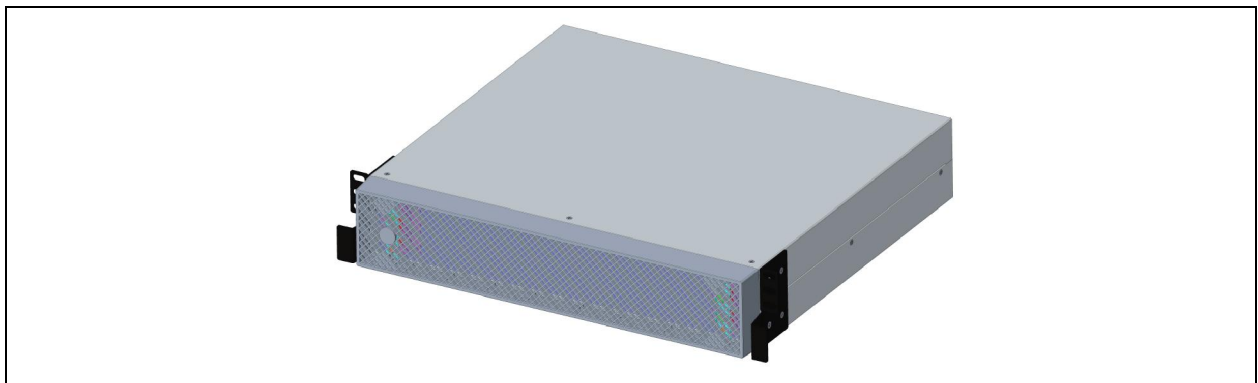

2.6 Major Internal Components and Operating Principle

Figure 2.8 below and Figure 2.9 below, show the basic operation of the system, while Table 2.2 below describes the function of the major components in the UPS. The actual I/O connections for the various models may be divided into different types, see Branch Circuit Breaker on page 18.

Figure 2.8 Basic Operating Principle Diagram — Tower UPS

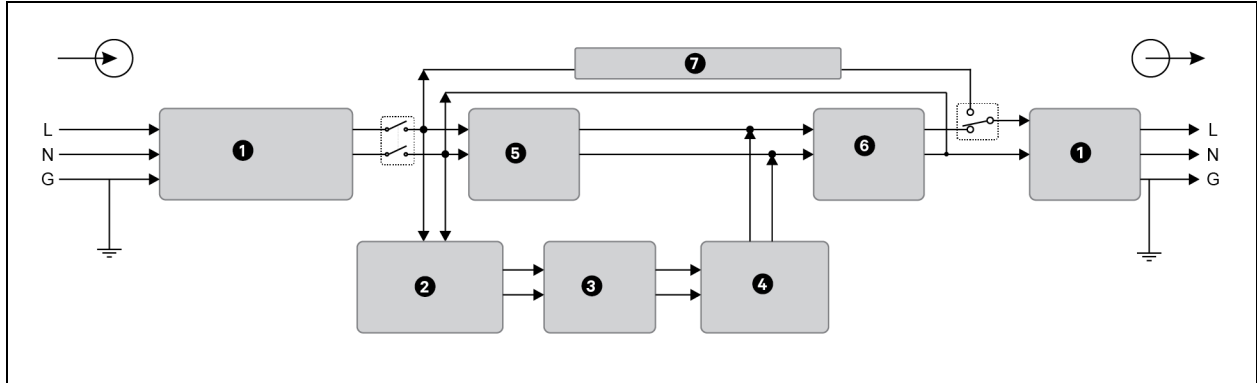

Figure 2.9 Basic Operating Principle Diagram — Rack/Tower UPS

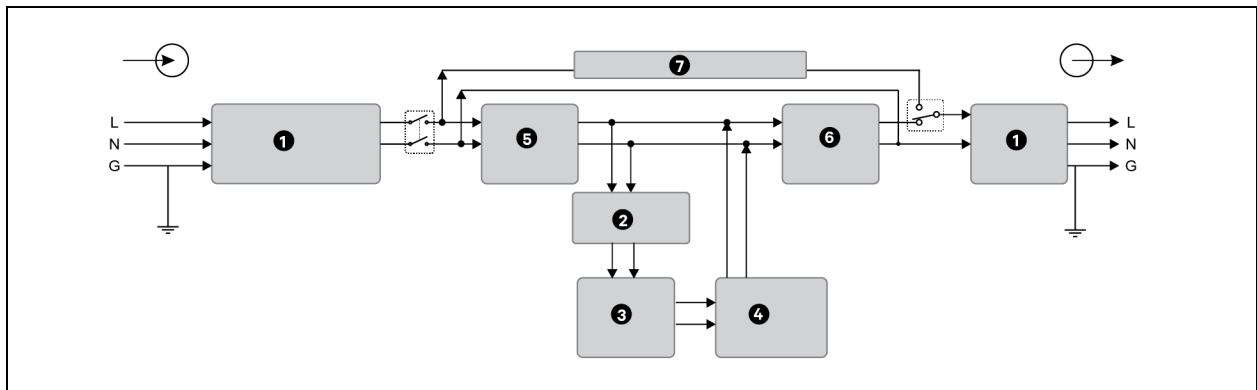

Table 2.2 Major Components

Item	Component	Operation/Function
1	Transient Voltage Surge Suppression (TVSS) and EMI/RFI Filters	TVSS provide surge and lightning protection. EMI/RFI filter electromagnetic interference (EMI) and radio frequency interference (RFI). Minimize surges or interference present in the utility power and protect devices connected on the same branch as the UPS.
2	Battery Charger	Regulates input AC power to continuously float charge the batteries. Batteries are charged when the UPS is plugged in, even when not powered-on.
3	Batteries	Valve regulated, non-spillable, lead acid batteries. NOTE: To maintain the battery design life, operate the UPS in an ambient temperature of 20 °C to 25 °C (68 °F to 77 °F).
4	DC to DC Converter	Raises the DC voltage from the battery to the optimum operating voltage for the inverter. This allows the inverter to operate continuously at its optimum efficiency and voltage, thus increasing reliability.

Table 2.2 Major Components (continued)

Item	Component	Operation/Function
5	Rectifier/Power Factor Correction (PFC) Circuit	In normal operation, converts utility AC power to regulated DC power for use by the inverter while ensuring that the wave shape of the input current used by the UPS is near ideal. Extracting this sine-wave input current ensures efficient use of utility power and reduces reflected harmonic distortion making cleaner power available to devices that are not protected by the UPS.
6	Inverter	In normal operation, inverts the DC output of the PFC circuit into precise, regulated sine-wave AC power. When utility power fails, the inverter receives DC power from the DC to DC converter. In either operating mode, the UPS inverter remains online, generating clean, precise, regulated AC output power.
7	Internal Bypass (Dynamic Bypass)	In the unlikely event of UPS failure such as overload or over temperature, automatically transfers the connected load to bypass. To manually transfer the connected load from inverter to bypass, see Transferring from Normal to Bypass Mode on page 23.

NOTE: The bypass power path does not protect the connected equipment from disturbances in the mains power supply.

2.7 UPS Operating Modes

2.7.1 Normal Mode

When utility power is normal, the UPS will operate in *Normal* mode (double conversion) that employs the rectifier and inverter to provide stabilized voltage and frequency power to the connected equipment. The battery charger will recharge or maintain the battery at full capacity. **Figure 2.10** below shows the diagram of *Normal* mode.

Figure 2.10 Normal Mode Operation

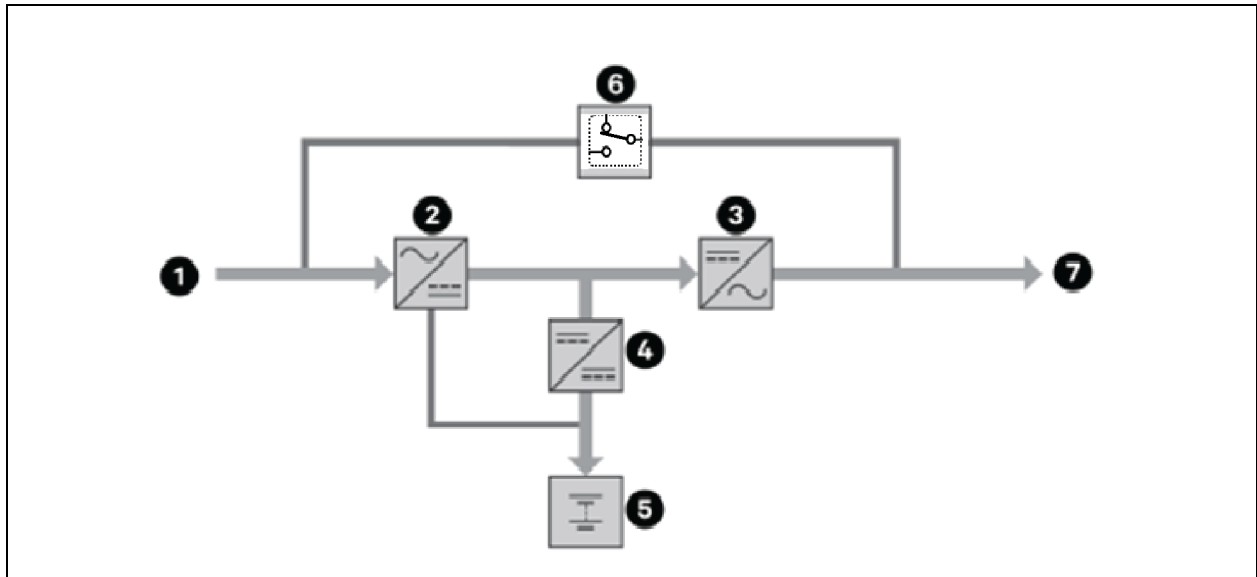

Item	Description
1	Mains/Utility power (bypass input)
2	Rectifier/PFC
3	Inverter
4	Battery charger
5	Battery
6	Dynamic Bypass
7	UPS output

2.7.2 Bypass Mode

Bypass mode supplies power to the load from the input source (mains/utility power), if an overload or fault occurs during normal operation. The LCD Flow screen displays *On Bypass*. **Figure 2.11** below shows the diagram of *Bypass* mode.

NOTE: If mains power fails or the mains voltage goes outside of the permissible range during *Bypass* mode operation, the UPS shuts down and no output is supplied to the connected equipment.

Figure 2.11 Bypass Mode Operation

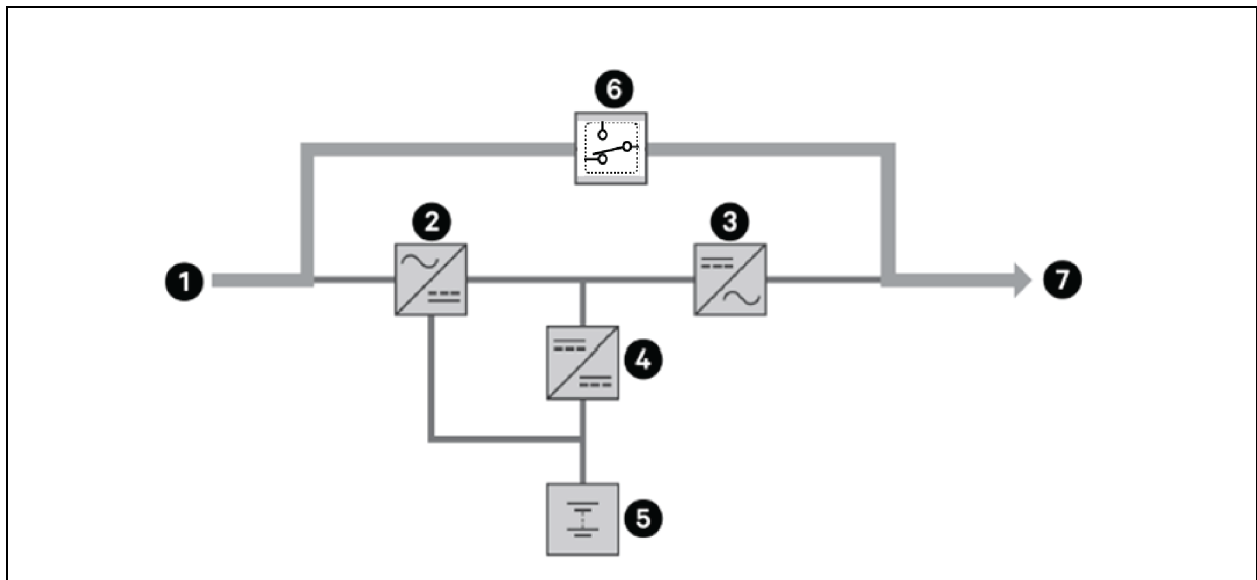

Item	Description
1	Main/Utility input (bypass input)
2	Rectifier/PFC
3	Inverter
4	Battery charger

Item	Description
5	Battery
6	Dynamic bypass
7	UPS output

2.7.3 Battery Mode

Battery mode supplies battery power to the load if utility power fails or if the utility voltage goes outside of the permissible range. The LCD screen displays battery icon and the buzzer beeps once each second, see Figure 2.12 below shows the diagram of Battery mode.

NOTE: The batteries are fully charged before shipment. However, transportation and storage inevitably cause some loss of capacity. To ensure adequate back up time, it is recommended to charge the batteries for at least 3 hours before connecting equipment.

Figure 2.12 Battery Mode Operation

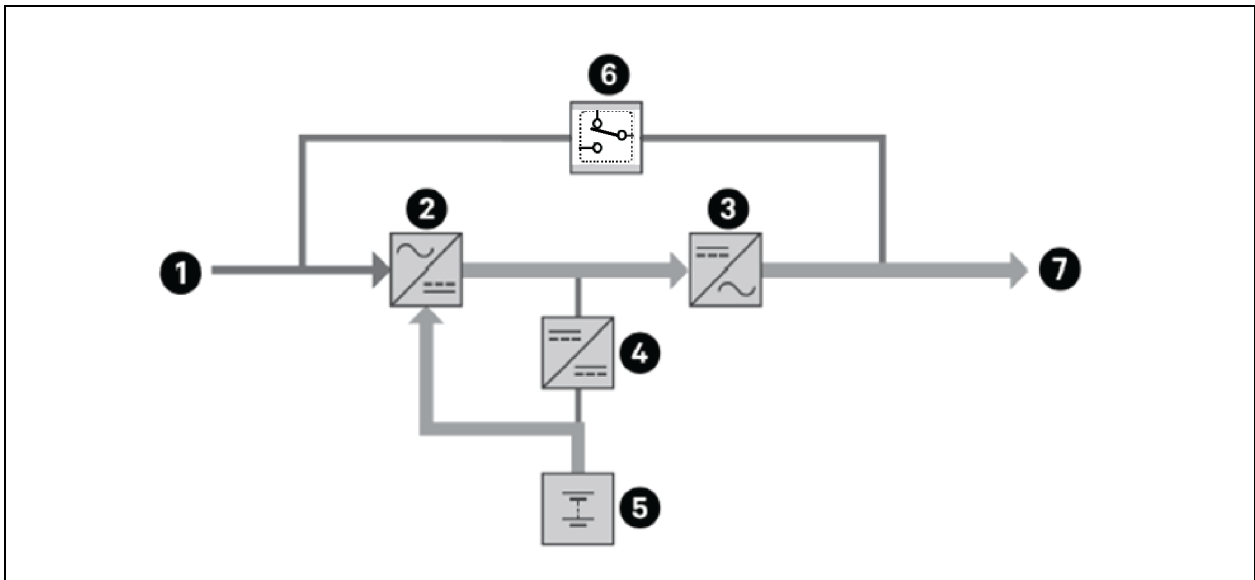

Item	Description
1	Mains/Utility input (bypass input)
2	Rectifier/PFC
3	Inverter
4	Battery charger
5	Battery
6	Dynamic bypass
7	UPS output

2.7.4 ECO Mode



The energy saving *ECO* mode reduces power consumption by powering the connected equipment via bypass while the bypass voltage and frequency are stable and within the user defined operational settings. *ECO* mode keeps the rectifier/PFC and inverter operating to maintain synchronization to the bypass. This allows seamless transfers to inverter power when the input mains power falls outside of those thresholds.

NOTE: Vertiv recommends using *ECO* mode to power equipment that is not sensitive to power grid quality to reduce mains power consumption.

2.7.5 Frequency Converter Mode

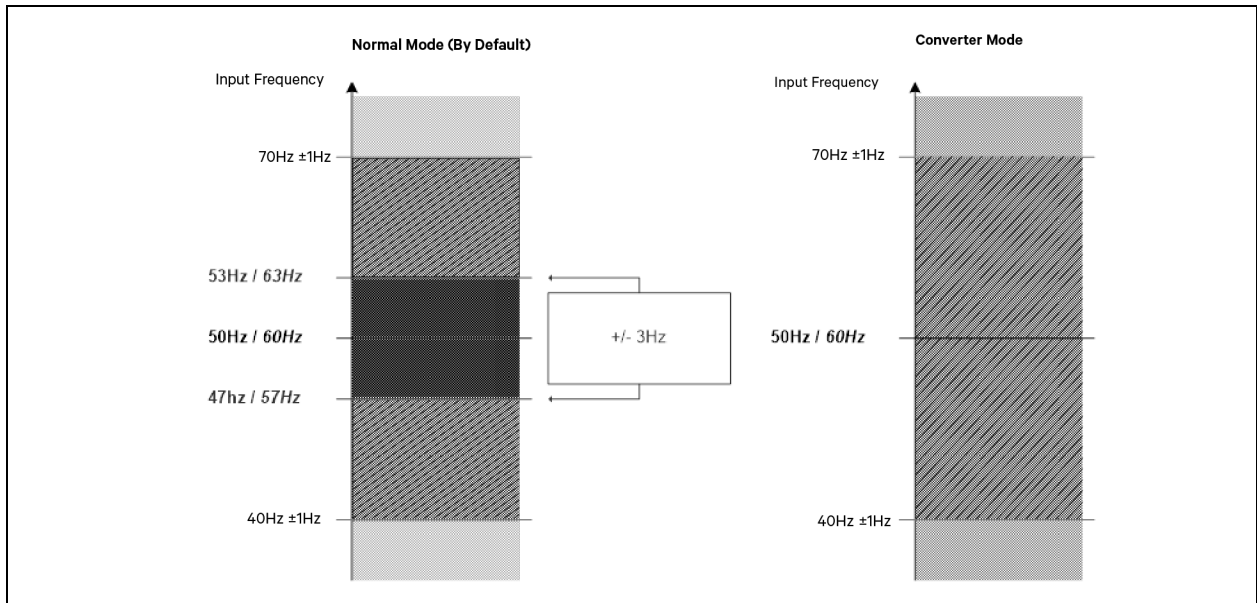
Figure 2.13 Frequency Converter Mode



Color Shade	Description
	UPS <i>Online</i> mode Input and output frequencies are synchronized.
	UPS <i>Online</i> mode Output frequency in <i>Frequency Converter</i> mode is 50/60 Hz ±0.5%. Beyond frequency range at heavy load (>70%), the output voltage tolerance will be ±2% and load measurement tolerance will be ±3%.
	UPS on <i>Battery</i> mode safety relay is open. Output frequency in <i>Frequency Converter</i> mode is 50/60 Hz ±0.5%.

This page intentionally left blank

3 Installation

IMPORTANT! Do not start the UPS until after the installation is finished, the system is commissioned by an Vertiv authorized engineer, and the external input circuit breakers are closed.



WARNING! Risk of electric shock. Can cause equipment damage, injury and death.

Before beginning installation, verify that all external overcurrent protection devices are open (off), and that they are locked out and tagged appropriately to prevent activation during the installation, verify with a voltmeter that power is off and wear appropriate, OSHA approved personal protective equipment (PPE) per NFPA 70E. Failure to comply can cause serious injury or death. Before proceeding with installation, read all instructions. Follow all local codes.

What's Included for Tower UPS:

- UPS and internal battery
- Printed quick installation guide, safety and regulatory statement, and factory test report
- Schuko, British, AUS — C13 input power cables (for 1-1.5 kVA)
- Schuko, British, AUS — C19 input power cables (for 2-3 kVA)
- C13 to C14 output power cable (1 cable for 1-1.5 kVA and 2 cables for 2-3 kVA)
- USB A to B cable

What's Included for Rack/Tower UPS:

- UPS and internal battery
- Printed quick installation guide, safety and regulatory statement, and factory test report
- 4-post rack mounting kit (1U)
- Rack mounting ears (left-right)
- Foot stands (left-right)
- Mounting hardware
- Schuko, British, AUS — C13 input power cables (for 1-1.5 kVA)
- Schuko, British, AUS — C19 input power cables (for 2-3 kVA)
- C13 to C14 output power cable (1 cable for 1-1.5 kVA and 2 cables for 2-3 kVA)
- USB A to B cable

What's Included for EBC:

- EBC with battery
- Printed quick installation guide, and safety and regulatory statement
- 4-post rack mounting kit (1U)
- Rack mounting ears (left-right)
- Extenders for foot stands
- Mounting hardware
- Power cable for connection of the EBC (0.6 meter)

3.1 Unpacking and Inspection



CAUTION: The UPS is heavy (see [Specifications](#) on page 41, for the weight). Take proper precautions when lifting or moving the unit.

Unpack the UPS and conduct the following checks:

- Inspect the UPS for shipping damage. If any damage is found, report it to the carrier and your local Vertiv representative immediately.
- Check the accessories included against the packing list. If there is any discrepancy, contact your local Vertiv representative immediately.

3.2 Pre-Installation Preparation

- Install the UPS indoors in a controlled environment, where it cannot be accidentally turned off. The installation environment should meet the specifications listed in [Specifications](#) on page 41.
- Place the UPS in an area of unrestricted airflow around the unit, away from water, flammable liquids, gases, corrosives, and conductive contaminants. Avoid direct sunlight.
- To ensure normal operation of the UPS at full load, it is necessary to maintain a maximum altitude of 1000 m for the UPS system. If it is being used at high altitude area, reduce the connected load accordingly.

NOTE: Operating the UPS in temperatures above 25 °C (77 °F) reduces battery life.

3.2.1 Installation Clearances

Maintain at least 100 mm (4 in.) clearance in the front and 300 mm (12 in.) in the rear and two side of the UPS. Do not obstruct the air inlets on the front panel and rear panel of the UPS. Blocking the air inlets reduces ventilation and heat dissipation, shortening the service life of the unit.

NOTE: When installing the UPS or making input and output connections, comply with all relevant safety codes and standards.

3.3 Installing the Tower UPS

UPS should be placed on the flat and clean surface. Place it in an area away from vibration, dust, humidity, high temperature, flammable liquids, gases, corrosive and conductive contaminants. Install the UPS indoors in a clean environment, where it is away from window and door. For more details, see [Figure 3.1](#) below.

Figure 3.1 Tower Installation — Tower UPS

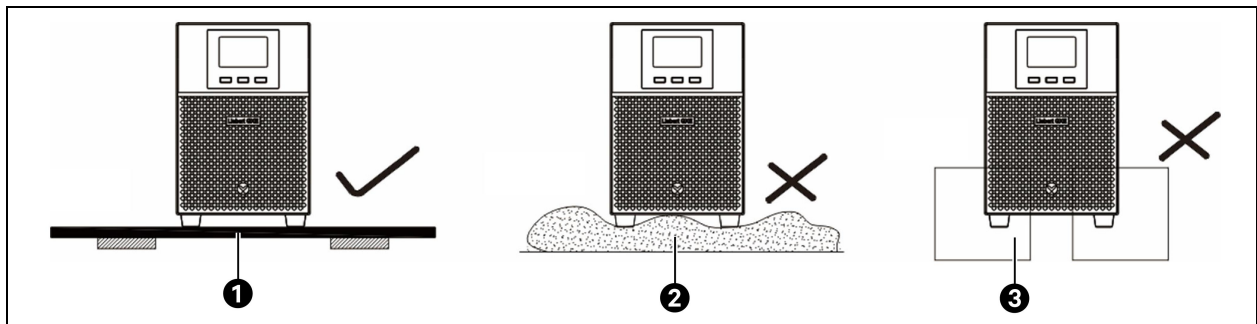

Item	Description
1	Flat surface installation — Recommended
2	Floor surface installation — Not recommended
3	Foam surface installation — Not recommended

3.4 Installing the Rack/Tower UPS

Depending on the type of the UPS and the availability of space, determine the type of installation. See [Tower Installation of the Rack/Tower UPS](#) below and [Rack Installation of the Rack/Tower UPS](#) on the next page .

3.4.1 Tower Installation of the Rack/Tower UPS

To install the UPS as a tower:

1. Take the support bases out of the accessories box.
2. If optional, EBCs will be connected, take out the spacers shipped with the battery cabinet.
3. Connect the spacers and the support bases as shown in **Figure 3.2** below . Each Vertiv™ Liebert® GXE UPS requires 2 support bases, one in the front and one in the rear.
4. Place the Liebert® GXE UPS and any battery cabinets on the 2 support bases.

Figure 3.2 Tower Installation — Rack/Tower UPS

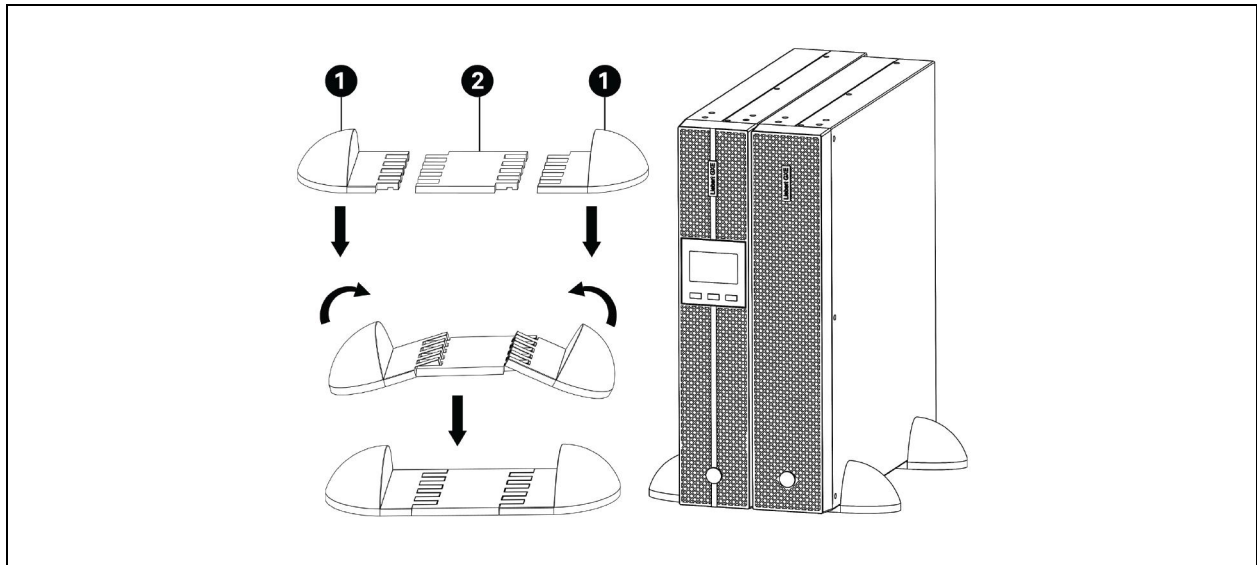

Item	Description
1	Support base
2	Spacer

3.4.2 Rack Installation of the Rack/Tower UPS

When installed in a rack enclosure, the Liebert® GXE UPS and EBC must be supported by a shelf or rack mount rails. Various rack mount options have different installation methods, refer to the installation instructions provided with the rack mount kit.

Figure 3.3 Rack Installation — Rack/Tower UPS

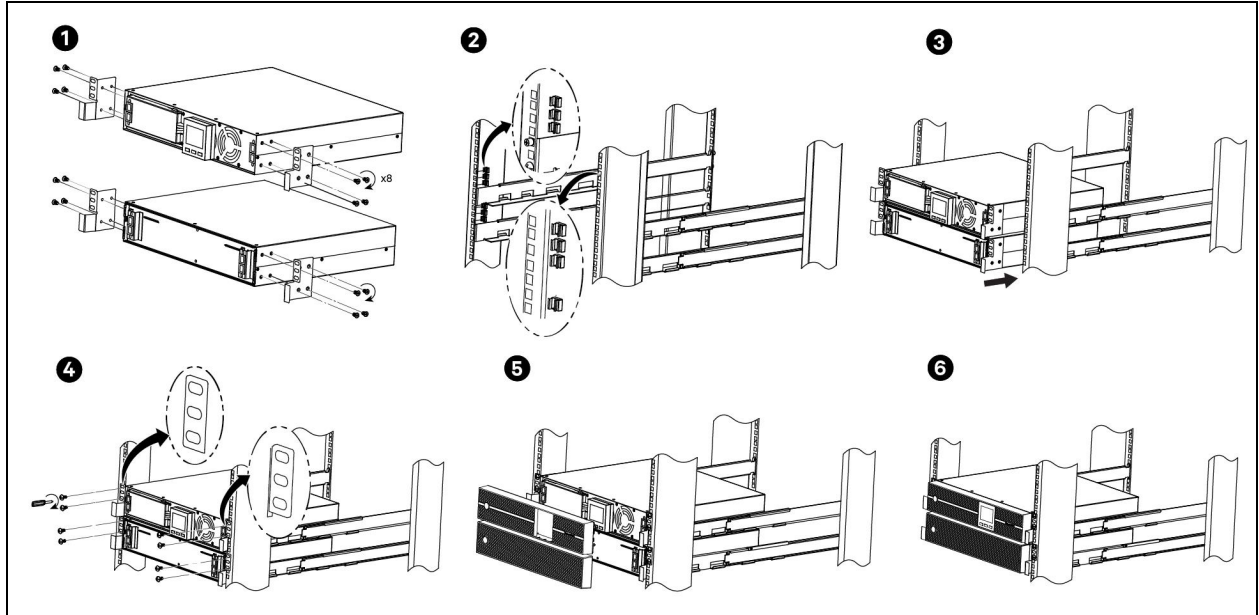

! **CAUTION:** The Liebert® GXE is heavy. The UPS must be installed as near the bottom of a rack as possible. If placed too high, it can make the rack top heavy and prone to tipping over. For unit weights, see [Specifications](#) on page 41 .

3.5 Installing the External Battery Cabinets (EBCs)

Optional EBCs may be connected in parallel to the Liebert® GXE rack/tower models to provide additional battery run time. For approximate battery run times with additional EBCs, see [Battery Run Times](#) on page 47 . EBCs are placed on one side of the UPS in a tower configuration or stacked beneath the UPS in a rack configuration. Up to 4 EBCs can be connected to the UPS. User can set EBC quantity from the setting menu, see [EBC Setting](#) section in [Table 5.4](#) on page 28 .

NOTE: Excessive charging current will flow which can affect the battery life, do not manually set the EBC quantity if EBCs are not connected.

⚡ **WARNING!** Risk of electric shock. Can cause injury or death. Disconnect all local and remote electric power supplies before working with the UPS. Ensure that the unit is shutdown and power has been disconnected before beginning any maintenance.

! **CAUTION:** The EBCs are heavy, see [Specifications](#) on page 41 . Take proper precautions when lifting them.

To install the EBCs:

1. Inspect the EBC for freight damage. Report damage to the carrier and your local dealer or Vertiv representative.
2. For tower installation:
 - An additional set of support base extensions is shipped with each EBC.
 - See the steps in [Installing the Rack/Tower UPS](#) on page 15 , to connect the support extenders and install the bases.

- or -
3. For rack installation:
 - Rack mount hardware is shipped with the EBC.
 - Refer to the instructions included with the rack mount kit to install.
4. Verify that the EBC breaker is in the *Off* position.
5. Connect the supplied EBC cables to the rear of the cabinet, then to the rear of the UPS, see **Figure 3.4** on the next page .
6. Manually set the EBCs quantity in the setting according to the number of EBCs connected to the system, see the *Setting* section in **Table 5.4** on page 28 .
7. Turn the EBC breaker to the *On* position.
8. Verify the circuit breaker on the EBC is in the *On* position.

NOTE: When removing an EBC, turn off the circuit breaker on the rear of the cabinet before disconnecting the cable.

NOTE: If shipping or storing the UPS for an extended time, disconnect the EBCs to minimize standby current drain on the batteries and help maintain design life.

Figure 3.4 Example of EBCs Connected to the UPS

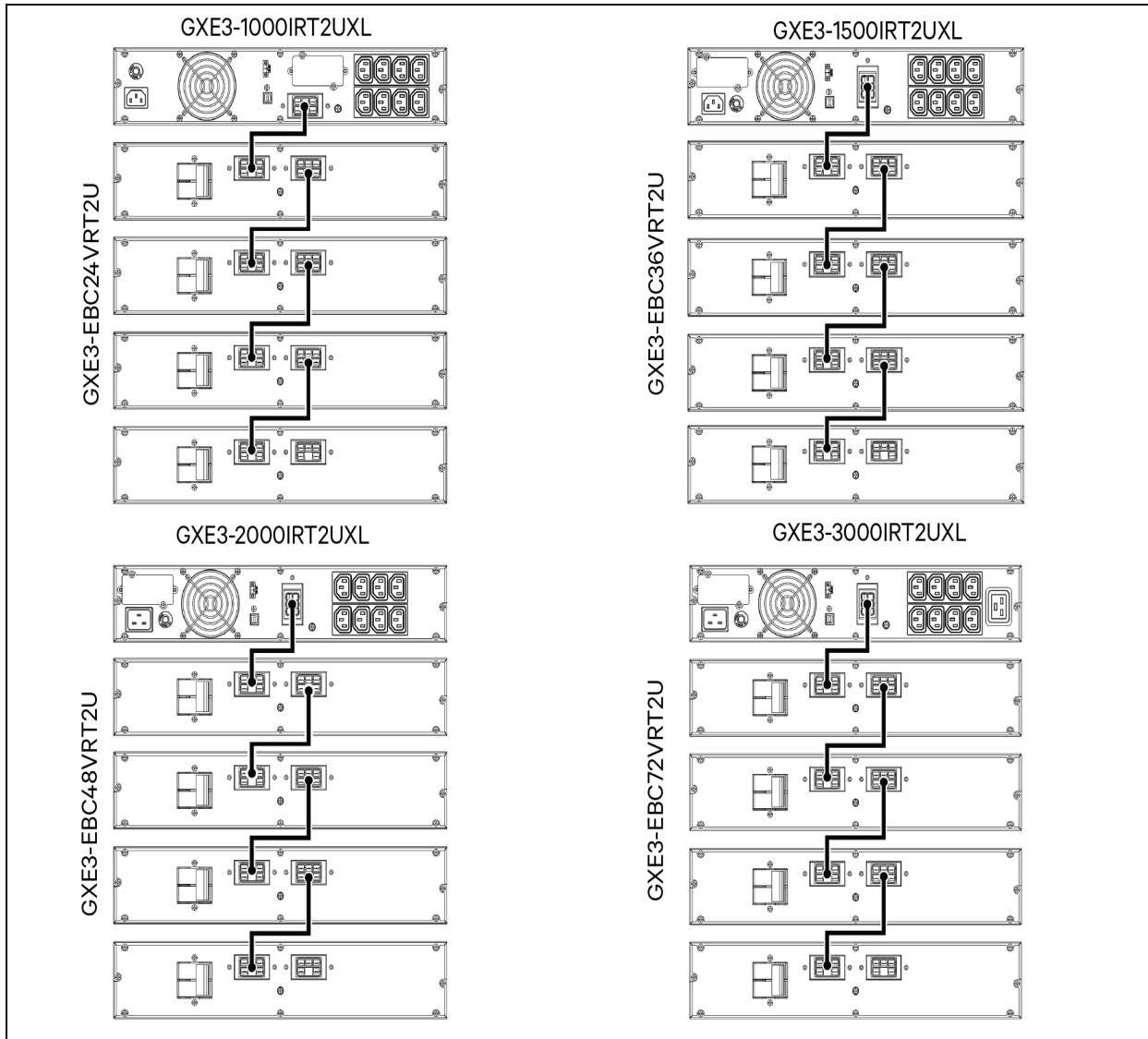

3.5.1 Branch Circuit Breaker

The installer must provide an upstream branch circuit breaker, see **Table 3.1** on the facing page, for the ratings.

Observe the following guidelines and specifications when making the hard wire input and output connections:

- Provide circuit breaker protection according to local codes. The mains disconnect should be within sight of the UPS or have an appropriate lock out.
- It is recommended to use a Class D circuit breaker.
- Maintain service space around the UPS or use flexible conduit.
- Provide the output distributions panels, circuit breaker protection, or emergency disconnects according to local codes.
- Do not install the input and output wiring in the same conduit.

Table 3.1 Branch Circuit Breaker Rating

Unit Rating (VA)	Recommended Breaker Rating (A)
1000	10
1500	13
2000	16
3000	20

3.6 Setup the UPS

3.6.1 Input connection

Plug the UPS into a two-pole, three-wire, grounded receptacle only. Avoid using extension cords. The power cord is supplied in the UPS package.

3.6.2 Output connection

Socket type outputs, simply connect devices to the outlets.

3.7 Communication Connections

The UPS offers several communication interfaces and ports.

NOTE: We recommend that signal cable lengths be less than 3 m (10 ft.), and are kept away from power cabling.

Figure 3.5 Communication Port

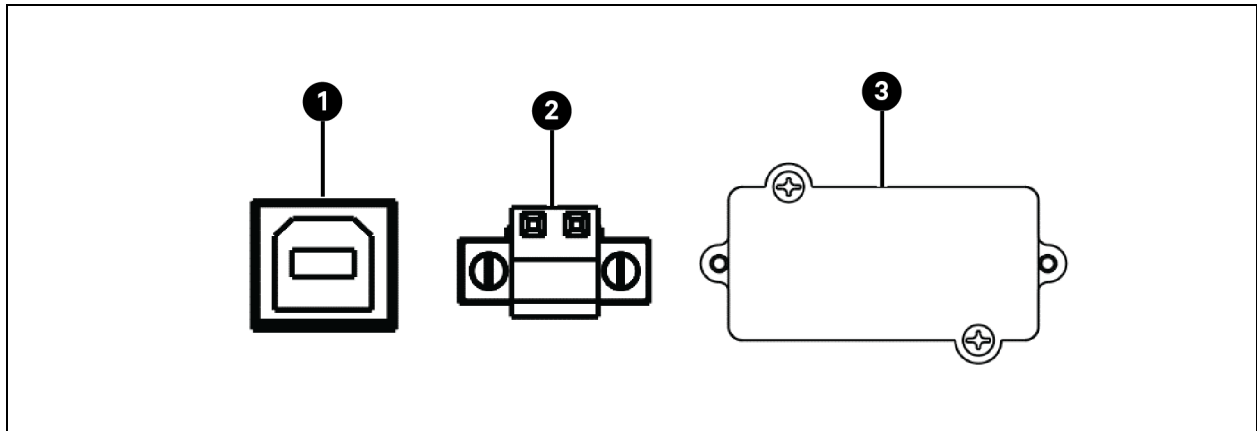

Item	Description
1	USB port
2	Emergency Power Off (EPO) port
3	Vertiv™ Liebert® IntelliSlot™

To allow for unattended UPS shutdown and status monitoring, connect the communication cable one end to the USB port and the other to the communication port of your PC. With the monitoring software installed, you can schedule UPS shutdown and monitor UPS status through PC.

3.7.1 Connecting Liebert® IntelliSlot™ Communication Card

The Vertiv™ Liebert® IntelliSlot™ IS-UNITY-SNMP provides SNMP only while the IS-UNITY-DP provides SNMP and RS-485 (Modbus IP or BACnet) monitoring of the UPS across the network building management system.

See the appropriate figure for your model in [Rear Panels](#) on page 4 , for the location of the card port.

To install a Liebert® IntelliSlot™ Card:

1. Remove the screws from the slot cover plate to remove it.
2. Insert the card into the slot, and secure with the screws that held the cover plate.

To make connections to the card, refer to the Installer/User Guide for the appropriate Liebert® IntelliSlot™ card available at www.vertiv.com.

3.7.2 Connecting a USB Cable

The UPS includes a USB type-B connector. See the appropriate figure for your model in [Rear Panels](#) on page 4 , for the location of the port.

The USB port connects the UPS to a network server or other computer system. The USB port supports HID. To use the HID protocol for monitoring, download Vertiv™ Power Assist from www.Vertiv.com/PowerAssist.

3.7.3 Connecting to the (Emergency Power Off) EPO Port

Keep the pin 1 and pin 2 closed for UPS normal operation. To activate EPO function, cut the wire between pin 1 and pin 2.

Figure 3.6 Enable and Disable EPO Function

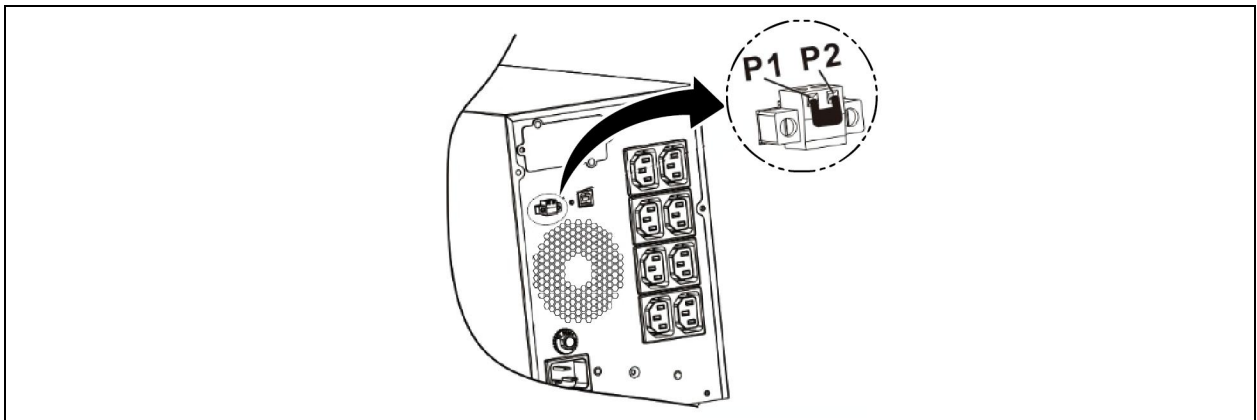

3.8 UPS Management Software

Vertiv offers two UPS management software packages:

1. Vertiv™ Power Insight software provides UPS management and graceful unattended system shutdown in the event of an extended power outage. Power Insight requires an optional network card. Visit www.vertiv.com/powerinsight for a free download of the software and additional information.
2. Vertiv™ Power Assist is an easy to use management and shutdown software package. Power Assist connects locally to the UPS via a USB port. Visit www.vertiv.com/powerassist for a free download of the software and additional information.

This page intentionally left blank

4 Operating the UPS

4.1 Starting Up the UPS

IMPORTANT! Do not start the UPS until after the installation is finished, the system is commissioned by an authorized engineer, and the external input circuit breakers are closed.



CAUTION: Starting the UPS applies mains/utility power to the output terminals. Make sure that the load power is safe and ready to accept power. If the load is not ready, isolate the load with the output terminal.

The UPS starts in *Normal* mode.

To start the UPS:

1. Ensure that the EPO connector on the rear of the unit has a jumper installed or that it is properly wired to an emergency power off circuit (normally closed).
2. Make sure the breaker supplying power to the UPS is closed and close the input breaker on the rear of the UPS if included on your UPS model or if necessary press the **Input Circuit Breaker Reset** buttons at the rear of the UPS.
3. Close all output breakers in an external panel board, if used.
4. If EBCs are attached, close the breakers on the rear of each cabinet.
5. Power on the UPS by pressing and holding the **ON/Mute** button for at least 5 seconds.

For detailed description of UPS display functions and settings, see [Operation and Display Panel](#) on page 25 .

4.2 Mute the Audible Alarm

The audible alarm may sound during UPS operation. To mute the alarm, press and hold the **ON/Mute** button for 5 seconds. The button is located on the front panel display, see [Operation and Display Panel](#) on page 25 .

4.3 Transferring to Battery Mode

The UPS operates in *Normal* mode unless the mains/utility power fails or it is performing a battery self test, then it automatically transfers to *Battery* mode for the backup time available or the mains/utility power is restored. Once input power is restored, the UPS returns to *Normal* mode.

NOTE: Battery backup run times are listed in [Battery Run Times](#) on page 47 .

4.4 Transferring from Normal to Bypass Mode

Press **ON/Mute** and **Select** buttons simultaneously for 5 seconds. Then UPS will enter to *Bypass* mode. This action will be ineffective when the input voltage is out of acceptable range.

4.5 Transferring from Bypass to Normal Mode

Press **ON/Mute** and **Select** buttons simultaneously for 5 seconds. The UPS will enter to *Normal* mode.

The UPS automatically transfer back to *Normal* mode after an over temperature or overloaded fault is cleared and normal power is restored.

4.6 Transferring from Normal to Standby Mode

NOTE: Transferring to *Standby* mode will turn off the UPS output to the load.

Press and hold this **OFF / Enter** button at least 2 seconds to turn off the UPS in *Battery* mode. UPS will be in *Standby* mode under power normal or transfer to *Bypass* mode, if the bypass enable setting by pressing this button.

4.7 Shutting Down the UPS Completely



WARNING! Risk of electric shock. Can cause injury or death.

Disconnect all local and remote electric power supplies before working with the UPS. Ensure that the unit is shutdown and power has been disconnected before beginning any maintenance.

Press and hold the **OFF/Enter** button for 2 seconds. The UPS will enter *Standby* mode. Turn off the UPS input power. After 15 seconds, the UPS will be completely shutdown.

4.8 Emergency Power Off (EPO)

EPO turns off the UPS in emergency conditions such as fire or flood. When an emergency occurs, the EPO switch turns off the rectifier and inverter and stops powering the load immediately. The battery stops charging and disables discharging.

To manually power off in an emergency, disconnect the terminal connecting the EPO port on the rear of the UPS.

If mains/utility power is present, the UPS control circuit remains active even though output power is disabled. To remove all mains/utility power, disconnect the external main input circuit breaker.

5 Operation and Display Panel

The operation/display panel includes function keys, and an LCD interface to configure and control UPS operation.

Figure 5.1 LCD Display

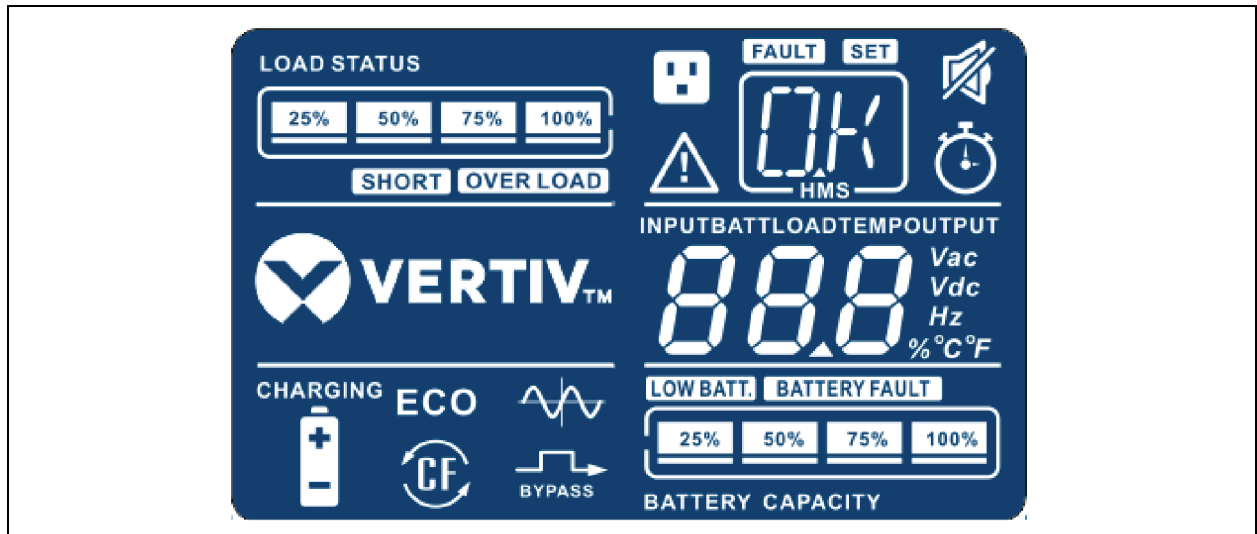















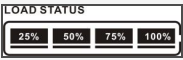

5.1 Button Operation

Table 5.1 Button Operation



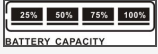











Button	Operation
ON/Mute Button	<ul style="list-style-type: none"> Turn on the UPS — Press and hold ON/Mute button for at least 2 seconds to turn on the UPS. Mute the alarm — After the UPS is turned on, press and hold this button for at least 5 seconds to disable the alarm system. But it is not applied to the situations when warnings or errors occur. Up key — Press this button to display previous selection in <i>UPS Setting</i> mode.
OFF/Enter Button	<ul style="list-style-type: none"> Turn off the UPS — Press and hold this button at least 2 seconds to turn off the UPS in <i>Battery</i> mode. UPS will be in <i>Standby</i> mode under power normal or transfer to <i>Bypass</i> mode if the Bypass enable setting by pressing this button. Confirm selection key — Press this button to confirm selection in <i>UPS Setting</i> mode.
Select Button	<ul style="list-style-type: none"> Switch LCD message — Press this button to change the LCD message for input voltage, input frequency, battery voltage, output voltage and output frequency. It will return back to default display when pausing for 10 seconds. <i>Setting</i> mode — Press and hold this button for 5 seconds to enter <i>UPS Setting</i> mode when the UPS is in <i>Standby</i> mode. Down key — Press this button to display next selection in <i>UPS Setting</i> mode.
ON/Mute + Select Button	<ul style="list-style-type: none"> Switch to <i>Bypass</i> mode — When the main power is normal, press ON/Mute and Select buttons simultaneously for 5 seconds. Then UPS will enter to <i>Bypass</i> mode. This action will be ineffective when the input voltage is out of acceptable range.
ON/Mute + OFF/Enter Button	<ul style="list-style-type: none"> Switch to <i>UPS Self test</i> mode — Press ON/Mute and OFF/Enter buttons simultaneously for 5 seconds to enter UPS self testing while in <i>AC</i> mode, <i>ECO</i> mode, or <i>Converter</i> mode.

Table 5.2 Display Function Description

Parameter	Display	Function
Remaining Backup time information		Indicates the remaining backup time in pie chart
		Indicates the remaining backup time in numbers H: hours, M: minute, S: second
Setting operation		Indicates the setting operation
Fault information		Indicates that the warning and fault occurs
		Indicates the warning and fault codes, and the codes are listed in detail in 3-5 section
Mute operation		Indicates that the UPS alarm is disabled
Output and Battery voltage information		Indicates the input and output voltage, frequency, battery voltage, load information, and internal temperature VAC: input/output voltage, VDC: battery voltage, Hz: frequency, %: load level, °C/°F: temperature,
Load information		Indicates the load level by 0-25%, 26-50%, 51-75%, and 76-100%
		Indicates overload
		Indicates the load or the UPS output is short circuit
Mode operation information		Indicates the UPS is in <i>Online</i> mode
		Indicates the UPS is in <i>Battery</i> mode
		Indicates the UPS is <i>Bypass</i> mode
		Indicates the UPS is in <i>ECO</i> mode
		Indicates the UPS is in <i>Converter</i> mode
		Indicates the UPS is charging battery
Battery information		Indicates the Battery level by 0-25%, 26-50%, 51-75%, and 76-100%
		Indicates the battery is fault
		Indicates low battery level and low battery voltage

5.2 LCD Display Wording

Table 5.3 LCD Display Wording

LCD Area	Abbreviation	Display Content	Meaning
	ENA		Enable
	DIS		Disable
	ESC		Escape
	b.L		Low battery
	O.L		Overload
	N.C		Battery is not connected
	O.C		Overcharge
	C.H		Charger
	b.F		Battery fault
	b.R		Battery replace
	b.V		Bypass voltage range
	W.T		Waiting
	F.U		Bypass frequency unstable
	E.E		EEPROM error
	E.P		EPO
	OK		No alarm or error

5.3 UPS Setting

Table 5.4 UPS Setting







Setting	Interface	Description
Output Voltage Setting		<p>Parameter 1 — Output voltage setting</p> <p>User can choose the following output voltage:</p> <ul style="list-style-type: none"> • 220 — Presents output voltage is 220 VAC • 230 — Presents output voltage is 230 VAC (Default) • 240 — Presents output voltage is 240 VAC
Frequency Converter Enable/Disable		<p>Parameter 2 — Enable or disable Converter mode. User can choose the following two options:</p> <ul style="list-style-type: none"> • CF ENA — Converter mode enable • CF DIS — Converter mode disable (Default)
Output Frequency Setting	 	<p>Parameter 3 — Output frequency setting.</p> <p>User can set the initial frequency on Battery mode:</p> <ul style="list-style-type: none"> • BAT 50 — Presents output frequency is 50 Hz (Default) • BAT 60 — Presents output frequency is 60 Hz <p>If Converter mode is enabled, user can choose the following output frequency:</p> <ul style="list-style-type: none"> • CF 50 — Presents output frequency is 50 Hz (Default) • CF 6 — Presents output frequency is 60 Hz
ECO Enable/Disable		<p>Parameter 4 — Enable or disable ECO function. User can choose the following two options:</p> <ul style="list-style-type: none"> • ENA — ECO mode enable • DIS — ECO mode disable (Default)
ECO High Loss Voltage Range Setting		<p>Parameter 5 — Set the acceptable high voltage point for ECO mode by pressing Down key or Up key.</p> <ul style="list-style-type: none"> • High loss voltage in ECO mode. • For 220/230/240 VAC models, the setting range is from +7 V to +24 V of the nominal voltage (Default is +12 V)
ECO Low Loss Voltage Range Setting		<p>Parameter 6 — Set the acceptable low voltage point for ECO mode by pressing Down key or Up key.</p> <ul style="list-style-type: none"> • Low loss voltage in ECO mode. • For 220/230/240 VAC models, the setting range is from -7 V to -24 V of the nominal voltage (Default is -12 V)

Table 5.4 UPS Setting (continued)

Setting	Interface	Description
Bypass Enable/Disable		Parameter 7 — Enable or disable Bypass function (Start on UPS). User can choose the following two options: <ul style="list-style-type: none"> • ENA — Bypass enable. In this setting, the output power to the receptacles through the bypass path. • DIS — Bypass disable (Default). In this setting, the output power to the receptacles through the inverter path.
Bypass High Voltage Range Setting		Parameter 8 — Set the acceptable high voltage point for <i>Bypass</i> mode by pressing the Down key or Up key. <ul style="list-style-type: none"> • 230-264 — Setting the high voltage point is from 230 VAC to 264 VAC (Default is 264 VAC)
Bypass Low Voltage Range Setting		Parameter 9 — Set the acceptable low voltage point for <i>Bypass</i> mode by pressing the Down key or Up key. <ul style="list-style-type: none"> • 180-230 — Setting the low voltage point is from 180 VAC to 230 VAC. (Default is 180 VAC)
Autonomy Limitation Setting		Parameter 10 — Set up backup time on <i>Battery</i> mode for general outlets. <ul style="list-style-type: none"> • 0-999 — Setting the backup time in minutes from 0-999 in <i>Battery</i> mode. • 0 — When setting as 0, the backup time will be only 10 seconds. • 999 — When setting as 999, the backup time setting will be disabled
EBC Setting (Only for the UPS with External Battery Connection Function)		Parameter 11 — Set the EBC number. Maximum settable 4 <ul style="list-style-type: none"> • 0 — The external battery is not connected. (Default) • 4 — 4 EBCs
Exit Setting		ESC — Exit the setting menu.

5.4 Operating Mode Description

Table 5.5 Operating Mode Description





Operating Mode	Description	LCD Display
Switch On	When pressing ON/MUTE button, if battery voltage is within acceptable range, ON will flash until the UPS is turned on.	
Online Mode	When the input voltage is within acceptable range, UPS will provide pure and stable AC power to output. The UPS will also charge the battery at <i>Online</i> mode.	
ECO Mode	Energy saving mode: When the input voltage is within voltage regulation range, UPS will bypass voltage to output for energy saving.	
Frequency Converter Mode	When input frequency is within 40 Hz to 70 Hz, the UPS can be set at a constant output frequency, 50 Hz or 60 Hz. The UPS will still charge battery under this mode.	
Battery Mode	When the input voltage is beyond the acceptable range or power failure and alarm is sounding every 5 second, UPS will backup power from battery.	

Table 5.5 Operating Mode Description (continued)

Operating Mode	Description	LCD Display
Bypass Mode	When input voltage is within acceptable range but UPS is overload, UPS will enter <i>Bypass</i> mode or <i>Bypass</i> mode can be set by front panel. Alarm is sounding every 10 second.	
Standby Mode	UPS is powered off without output power, but the battery still can be charged.	
Fault Mode	The UPS is in <i>Fault</i> mode when no output power is supplied from the UPS and the fault icon flashes on the LCD display, although the information of UPS can be displayed in the screen.	

5.5 Fault Reference Code



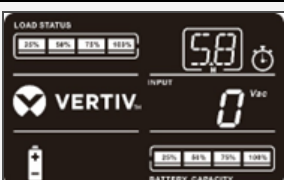











Table 5.6 Fault Reference Code

Fault Event	Fault Code	Icon	UPS Output ON/OFF
Bus start fail	01	x	ON
Bus over	02	x	ON
Bus under	03	x	ON
Bus unbalance	04	x	ON
Bus short	05	x	OFF
Inverter soft start fail	11	x	ON
Inverter voltage high	12	x	ON
Inverter voltage Low	13	x	ON
Inverter output short	14	SHORT	OFF
Battery voltage too high	27	BATTERY FAULT	ON
Battery voltage too low	28	BATTERY FAULT	ON
Over temperature	41	x	ON
Over load	43	OVER LOAD	ON
Charger failure	45	x	ON

NOTE: UPS Status — Apart of error 14, the UPS have no output (OFF). Others error code, the UPS have output (ON).

5.6 Warning Indicator

Table 5.7 Warning Indicator

Warning	Indicator		Alarm
	Word	Icon (Flashing)	
Low battery	b.L	 LOW BATT.	Sounding every 2 seconds
Overload	O.L	 OVER LOAD	Sounding every second
Battery is not connected	N.C	 	Sounding every 2 seconds
Overcharge	O.C	 	Sounding every 2 seconds
Over temperature	W.T		Sounding every 2 seconds
Charger failure	C.H		Sounding every 2 seconds
Out of bypass voltage range	b.V	 	Sounding every 2 seconds
Battery fault	b.F	 BATTERY FAULT	Sounding every 2 seconds
Battery replace	b.R	 BATTERY FAULT	Sounding every 3 seconds
Bypass frequency unstable	F.U		Sounding every 2 seconds
EEPROM error	E.E		Sounding every 2 seconds
EPO enabled	E.P		Sounding every 2 seconds

5.7 Communication

Table 5.8 Communication

Item	Specification
Communication port	
USB	USB 2.0 with full speed, HID for the Vertiv™ Liebert® GXE
Communication slot	
Optional network management cards	Vertiv™ Liebert® IS-UNITY-SNMP
Relay option card	Vertiv™ Liebert® IS-RELAY
Monitor Software	
Software	Vertiv™ Power Assist and Power Insight
EPO	
Default status	Normally close (NC)

This page intentionally left blank

6 Maintenance



WARNING! Risk of electric shock. Can cause equipment damage, injury and death.
A battery can present a risk of electrical shock and high short circuit current.

Observe the following precautions when working on batteries:

- Remove watches, rings and other metal objects.
- Use tools with insulated handles.
- Wear rubber gloves and boots.
- Do not lay tools or metal parts on top of batteries.
- Disconnect input power prior to connecting or disconnecting battery terminals.
- If the battery kit is damaged in any way or shows signs of leakage, contact your Vertiv representative immediately.
- Handle, transport, and recycle batteries in accordance with local regulations.
- Determine if the battery is inadvertently grounded. If it is, remove the source of the ground. Contact with any part of a grounded battery can result in electrical shock. The likelihood of such shock will be reduced if grounds are removed during installation and maintenance (applicable to a UPS and a remote battery supply not having a grounded supply circuit).

6.1 Replacing Batteries



WARNING! Risk of electric shock. Can cause injury or death.
Disconnect all local and remote electric power supplies before working with the UPS. Ensure that the unit is shutdown and power has been disconnected before beginning any maintenance.



WARNING! Risk of electric shock. Can cause equipment damage, injury and death.
A battery can present a risk of electrical shock and high short circuit current. Do not open or damage the battery.



WARNING! Risk of explosion. Can cause equipment damage, injury and death.
Do not dispose of the battery in a fire, as it may explode. Released electrolyte is toxic and is harmful to skin and eyes. If electrolyte comes into contact with the skin, wash the affected area immediately with plenty of clean water and get medical attention.



WARNING! Risk of explosion. Can cause equipment damage, injury and death.
A battery can explode if the battery is replaced by an incorrect type. Dispose of used batteries according to the instructions included with the battery pack.

Read all safety cautions before proceeding. A trained user can replace the internal battery pack when the UPS is in a restricted access location (such as a rack or server closet). To obtain the appropriate replacement battery packs, refer to **Table 6.1** on the next page and contact your local dealer or Vertiv representative.

NOTE: EBC batteries are not replaceable. When EBC batteries have aged, purchase a new EBC of the same part number to replace. Save packaging and return the aged EBCs to Vertiv for recycling or recycle locally.

Table 6.1 Replacement Battery Pack Model Numbers

UPS Model Number	Battery Pack Model Number	Quantity Required
GXE3-1000IRT2UXL	GXTRT-24BATKIT	1
GXE3-1000IMT		
GXE3-1500IRT2UXL	GXTRT-36BATKIT	
GXE3-1500IMT		
GXE3-2000IRT2UXL	GXTRT-48BATKIT	
GXE3-2000IMT		
GXE3-3000IRT2UXL	GXTRT-72BATKIT	
GXE3-3000IMT	VUPS-72VBATKIT9AMT	

To replace a battery pack, see Figure 6.1 below and Figure 6.2 on the facing page :

NOTE: The internal battery pack is hot swappable and user replaceable. However, exercise caution because during this procedure, the load is unprotected from disturbances and power outages. Do not replace the battery while the UPS is operating in *Battery* mode. This will result in a loss of output power and will drop the connected load.

Figure 6.1 Battery Replacement — Tower UPS

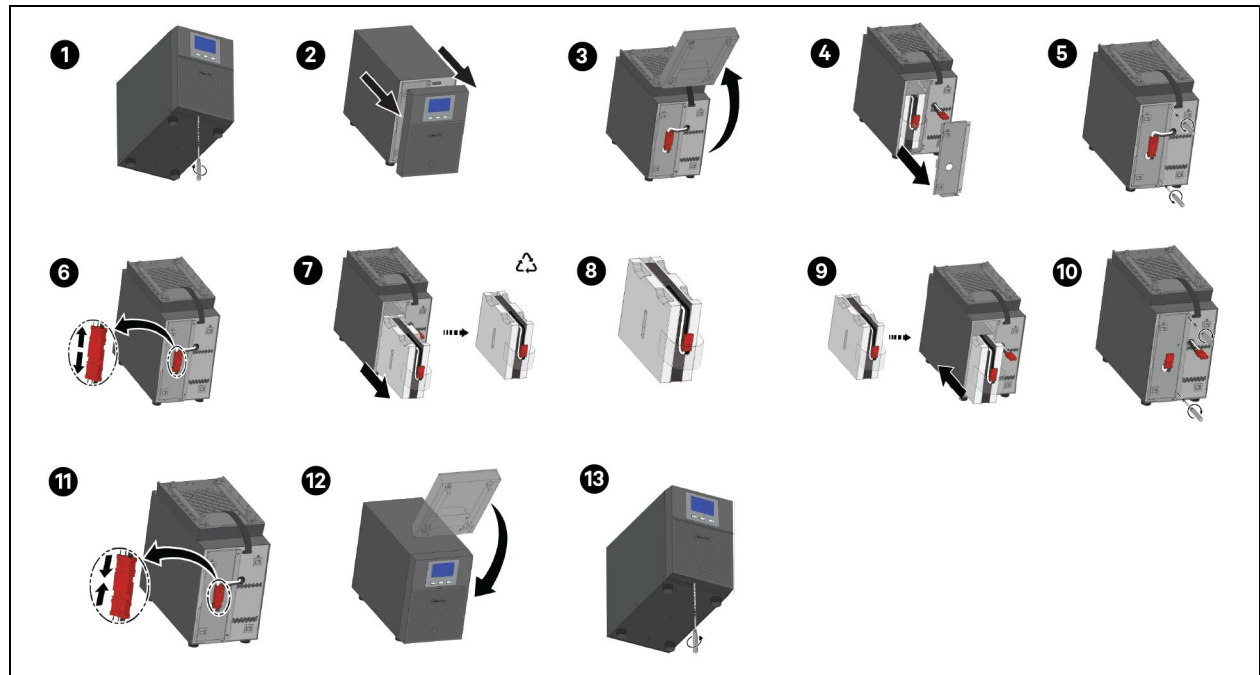
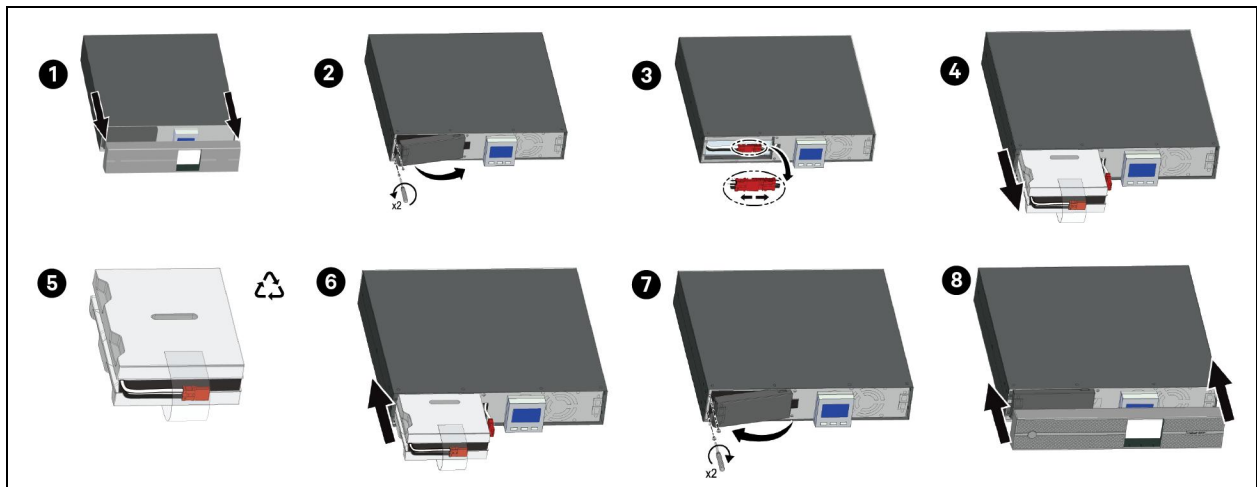

Figure 6.2 Battery Replacement — Rack/Tower UPS



6.2 Charging Batteries

The batteries are valve regulated, non-spillable, lead acid batteries and should be kept charged to attain their design life. The UPS charges the batteries continuously when it is connected to the utility input power.

If the UPS and/or EBCs will be stored for an extended time, we recommend connecting the UPS to the input power to ensure full recharge of the internal batteries, see **Table 6.2** on the next page. If EBCs are being recharged the recharge time should add 4 hours for each EBC connected to the UPS.

6.3 Checking UPS Operation

NOTE: Operation check procedures may interrupt output power supplied to the connected load.

We recommend checking the UPS operation once every 6 months. Ensure that output power loss to the connected load will not cause data loss or other errors before conducting the check.

1. Press the **Enter** button to check the indicators and display function, see [Operation and Display Panel](#) on page 25.
2. Check for any alarm or fault indicators on the operation/display panel.
3. Make sure that there are no audible or silenced alarms.

6.4 Cleaning the UPS



WARNING! Risk of electric shock. Can cause injury or death.

Disconnect all local and remote electric power supplies before working with the UPS. Ensure that the unit is shutdown and power has been disconnected before beginning any maintenance.

The UPS requires no internal cleaning. If the outside of the UPS becomes dusty, wipe with a dry cloth. Do not use liquid or aerosol cleaners. Do not insert any objects into the ventilation holes or other openings in the UPS.

6.5 Storage

The UPS system contains no user serviceable parts. If the battery service life (3 to 5 years at 25 °C ambient temperature) has been exceeded, the batteries must be replaced. In this case, please contact your dealer.

IMPORTANT! Be sure to deliver the spent battery to a recycling facility or ship it to your dealer in the replacement battery packing material.

Before storage, it is recommended to charge the each UPS and EBC for 12 hours. Store the UPS and EBCs covered and in a controlled environment that is as cool as possible and in a dry location. For prolonged storage refer to the **Table 6.2** below for the recharge requirements to keep the batteries in useful condition.

Table 6.2 Storage and Recharge Details

Storage Temperature	Recharge Frequency	Charging Duration
Below -15 °C	Not Recommended	N/A
-15 °C to 20 °C	Every 9 Months	12-16 Hours
20 °C to 30 °C	Every 6 Months	12-16 Hours
30 °C to 45 °C	Every 3 Months	12-16 Hours
Above 45 °C	Not Recommended	N/A

6.6 Firmware Updates

The UPS may be updated through the USB connection. Please contact your Vertiv representative or contact Technical Support at <https://www.vertiv.com/en-us/support/>.

7 Troubleshooting

If the UPS system does not operate correctly, solve the problem by using the **Table 7.1** below .

Table 7.1 Troubleshooting

Symptom	Possible Cause	Remedy
No indication and alarm even though the mains is normal.	The AC input power is not connected well.	Check if the input power cord firmly connected to the mains.
	The AC input is connected to the UPS output.	Plug the AC input power cord to the AC input correctly.
The icons of and the warning code flashing on LCD display. Alarm is sounding every 2 seconds.	The external or internal battery is incorrectly connected.	Check if all the batteries are connected well.
Fault code is shown as 27 on LCD display and alarm is continuously sounding.	Battery voltage is too high or the charger is fault.	Contact Vertiv Technical Support.
Fault code is shown as 28 on LCD display and alarm is continuously sounding.	Battery voltage is too low or the charger is fault.	Contact Vertiv Technical Support.
The icons and flashing on LCD display. Alarm is sounding every second.	UPS is overload	Remove the excess loads from the UPS output.
	UPS is overloaded. Devices connected to the UPS are fed directly by the electrical network via the Bypass.	
	After repetitive overloads, the UPS is locked in the <i>Bypass</i> mode. Connected devices are fed directly by the mains.	Remove the excess loads from the UPS output first. Then shutdown the UPS and restart it.
Fault code is shown as 43 and the icon is lighting on LCD display. Alarm is continuously sounding.	The UPS shutdown automatically because of overload at the UPS output.	Remove excess loads from UPS output and restart it.
Fault code is shown as 14 on LCD display and alarm is continuously sounding.	The UPS shutdown automatically because short circuit occurs on the UPS output.	Check the output wiring and if connected devices are in the short circuit status.
Fault code is shown as 01, 02, 03, 11, 12, 13 and 41 on LCD display and alarm is continuously sounding.	A UPS internal fault has occurred. There are two possible results: <ul style="list-style-type: none"> The load is still supplied, but directly from AC power via bypass. The load is no longer supplied by power. 	Contact your dealer.
Battery backup time is shorter than nominal value.	Batteries are not fully charged.	Charge the batteries for at least 5 hours and then check capacity. If the problem still persists, consult your dealer.
	Batteries are defective.	Contact your dealer to replace the battery.
Fault code is shows as 05 on LCD display. At the same time, alarm is continuously sounding and output is cut off.	A UPS internal fault has occurred and BUS is short circuited.	Consult your dealer. If the UPS power switched is on again before repair, the DC/DC mosfet will damage.
The icon and the warning code flashing on LCD display and alarm is sounding every 2 seconds.	EPO function is activated.	Set the circuit in closed position to disable EPO function.

This page intentionally left blank

8 Specifications

Table 8.1 Specifications — Tower UPS

Model		GXE3-1000IMT	GXE3-1500IMT	GXE3-2000IMT	GXE3-3000IMT
Capacity		1000 VA / 900 W	1500 VA / 1350 W	2000 VA / 1800 W	3000 VA / 2700 W
Input					
Input Nominal Voltage		220-240 VAC (default is 230 VAC)			
Voltage Range	Low Line Transfer	180 VAC / 160 VAC / 140 VAC / 110 VAC \pm 5% (Ambient Temperature $<$ 35 °C) (based on load percentage 100% to 80% / 80% to 70% / 70% to 50% / 50% to 0)			
	Low Line Comeback	195 VAC / 175 VAC / 155 VAC / 125 VAC \pm 5% (Ambient Temperature $<$ 35 °C) (based on load percentage 100% to 80% / 80% to 70% / 70% to 50% / 50% to 0)			
	High Line Transfer	300 VAC \pm 5%			
	High Line Comeback	290 VAC \pm 5%			
Frequency Range		40 Hz to 70 Hz			
Phase		Single phase with ground			
Power Factor		\geq 0.95 at nominal voltage (input voltage)			
Output					
Output Voltage		220 / 230 / 240 VAC			
AC Voltage Regulation		\pm 1% (Battery Mode)			
Frequency Range		47 Hz to 53 Hz or 57 Hz to 63 Hz (synchronized range)			
Frequency Range (Battery Mode)		50 Hz \pm 0.25 Hz or 60 Hz \pm 0.3 Hz			
Overload (Ambient Temperature $<$ 35 °C)		105% to 110%: Warning, transfer to bypass after 10 minutes (\pm 30 s) or shutdown on Battery mode. 110% to 130%: Warning, transfer to bypass after 30 seconds (\pm 4 s) or shutdown on Battery mode. 130% to 150%: Warning, transfer to bypass after 3 seconds (\pm 0.5 s) or shutdown on Battery mode. >150%: Immediate shutdown.			
Harmonic Distortion		\leq 3% THD (linear load), \leq 6% THD (non-linear load)			
Transfer Time	AC to Battery Mode	0 ms			
	Inverter to Bypass	4 ms (typical)			
Waveform (Battery Mode)		Pure Sinewave			
Efficiency					
Online Mode (Maximum)		89%	89%	89%	91%
ECO Mode (Maximum)		95%	95%	96%	96%

Table 8.1 Specifications — Tower UPS (continued)

Model	GXE3-1000IMT	GXE3-1500IMT	GXE3-2000IMT	GXE3-3000IMT
Capacity	1000 VA / 900 W	1500 VA / 1350 W	2000 VA / 1800 W	3000 VA / 2700 W
Battery				
Battery Type	Valve regulated, non-spillable, lead acid			
Numbers of Batteries (Series Connection)	2	3	4	6
Battery Capacity	9 Ah			
Runtime at 100% load	3.1 minutes	3.2 minutes	3.2 minutes	3.3 minutes
Runtime at 50% load	9 minutes	9 minutes	9 minutes	9.5 minutes
Charging Current	2 A			
Recharge Time (Internal Batteries, Typical)	<4 hrs. at 90%			
Physical				
Dimension (D x W x H ±2 mm)	315 x 160 x 245 mm	420 x 160 x 245 mm		425 x 200 x 345 mm
Net Weight (±0.5 kg)	11.8 kg	16.4 kg	19.4 kg	27.7 kg
Environment				
Operation Humidity	5-95% RH at 0-40 °C (non-condensing)			
Operation Temperature	0 °C to 40 °C			
Storage Temperature	-20 °C to 50 °C			
Elevation for Operating	<2000 m Normal operating, >2000 m, Derated 1% at every 100 m increased			
Elevation for Storage	0 - 15,000 m			
Noise Level	Less than 53 dBA to 1 m			
International Protection Code	IP20			
Agency				
Safety	EN/IEC 62040-1			
EMI/RFI/Immunity	EN/IEC 62040-2 EN/IEC 61000-3-2 EN 61000-3-3			
ESD	IEC/EN61000-4-2			
Radiated Susceptibility	IEC/EN61000-4-3			
Electrical Fast Transient	IEC/EN61000-4-4			
Surge Immunity	IEC/EN61000-4-5			
Environmental	ROHS, REACH, WEEE			

Table 8.1 Specifications — Tower UPS (continued)

Model	GXE3-1000IMT	GXE3-1500IMT	GXE3-2000IMT	GXE3-3000IMT
Capacity	1000 VA / 900 W	1500 VA / 1350 W	2000 VA / 1800 W	3000 VA / 2700 W
Transportation	ISTA Procedure 2A			
Certification	CE, UKCA, RCM, Morocco, EAC, KC/KCC, TISI, SABER, RoHS, WEEE			
NOTE: Product specifications are subject to change without further notice. During storage, we recommend charging the UPS as per Table 6.2 on page 38 .				

Table 8.2 Specifications — Rack/Tower UPS

Model	GXE3-1000IRT2UXL	GXE3-1500IRT2UXL	GXE3-2000IRT2UXL	GXE3-3000IRT2UXL
Capacity	1000 VA / 900 W	1500 VA / 1350 W	2000 VA / 1800 W	3000 VA / 2700 W
Input				
Input Nominal Voltage	220-240 VAC (default is 230 VAC)			
Voltage Range	Low Line Transfer	180 VAC / 160 VAC / 140 VAC / 110 VAC $\pm 5\%$ (Ambient Temperature $< 35^{\circ}\text{C}$) (based on load percentage 100% to 80% / 80% to 70% / 70% to 50% / 50% to 0)		
	Low Line Comeback	195 VAC / 175 VAC / 155 VAC / 125 VAC $\pm 5\%$ (Ambient Temperature $< 35^{\circ}\text{C}$) (based on load percentage 100% to 80% / 80% to 70% / 70% to 50% / 50% to 0)		
	High Line Transfer	300 VAC $\pm 5\%$		
	High Line Comeback	290 VAC $\pm 5\%$		
Frequency Range	40 Hz to 70 Hz			
Phase	Single phase with ground			
Power Factor	≥ 0.95 at nominal voltage (input voltage)			
Output				
Output voltage	220/230/240 VAC			
AC Voltage Regulation	$\pm 1\%$ (Battery Mode)			
Frequency Range	47 Hz to 53 Hz or 57 Hz to 63 Hz (synchronized Range)			
Frequency Range (Battery Mode)	50 Hz ± 0.25 Hz or 60 Hz ± 0.3 Hz			
Overload (Ambient Temperature $< 35^{\circ}\text{C}$)	105% to 110%: Warning, transfer to bypass after 10 minutes (± 30 s) or shutdown on Battery mode. 110% to 130%: Warning, transfer to bypass after 30 seconds (± 4 s) or shutdown on Battery mode. 130% to 150%: Warning, transfer to bypass after 3 seconds (± 0.5 s) or shutdown on Battery mode. >150%: Immediate shutdown.			
Harmonic Distortion	$\leq 3\%$ THD (linear load), $\leq 6\%$ THD (non-linear load)			

Table 8.2 Specifications — Rack/Tower UPS (continued)

Model		GXE3-1000IRT2UXL	GXE3-1500IRT2UXL	GXE3-2000IRT2UXL	GXE3-3000IRT2UXL
Capacity		1000 VA / 900 W	1500 VA / 1350 W	2000 VA / 1800 W	3000 VA / 2700 W
Transfer Time	AC to Battery Mode	0 ms			
	Inverter to Bypass	4 ms (typical)			
Waveform (Battery Mode)		Pure Sinewave			
Efficiency					
Online Mode (Maximum)		89%	89%	89%	91%
ECO Mode (Maximum)		95%	95%	96%	96%
Battery Kit					
Battery Type		Valve regulated, non-spillable, lead acid			
Numbers of Batteries (Series Connection)		2	3	4	6
Battery Capacity		9 Ah			
Runtime at 100% load		3.1 minutes	3.2 minutes	3.2 minutes	3.3 minutes
Runtime at 50% load		9 minutes	9 minutes	9 minutes	9.5 minutes
Charging Current		2 A (up to 6 A configurable with EBCs)			
Recharge Time (Internal Batteries, typical)		<4 hrs. at 90%			
Physical					
Dimension (D x W x H ±2 mm)		430 x 438 x 86 mm	430 x 438 x 86 mm		630 x 438 x 86 mm
Net Weight (±0.5 kg)		16 kg	19.6 kg	22.7 kg	31.5 kg
Environment					
Operation Humidity		5-95% RH at 0-40 °C (non-condensing)			
Operation Temperature		0 °C to 40 °C			
Storage Temperature		-20 °C to 50 °C			
Elevation for Operating		<2000 m Normal operating, >2000 m, Derated 1% at every 100 m increased			
Elevation for Storage		0-15,000 m			
Noise Level		Less than 53 dBA at 1 m			
International Protection Code		IP20			
Agency					
Safety		EN/IEC 62040-1			
EMI/RFI/Immunity		EN/IEC 62040-2 EN/IEC 61000-3-2 EN 61000-3-3			
ESD		IEC/EN61000-4-2			
Radiated Susceptibility		IEC/EN61000-4-3			

Table 8.2 Specifications — Rack/Tower UPS (continued)

Model	GXE3-1000IRT2UXL	GXE3-1500IRT2UXL	GXE3-2000IRT2UXL	GXE3-3000IRT2UXL
Capacity	1000 VA / 900 W	1500 VA / 1350 W	2000 VA / 1800 W	3000 VA / 2700 W
Electrical Fast Transient	IEC/EN61000-4-4			
Surge Immunity	IEC/EN61000-4-5			
Environmental	ROHS, REACH, WEEE			
Transportation	ISTA Procedure 2A			
Certification	CE, UKCA, RCM, Morocco, EAC, KC/KCC, TISI, SABER, RoHS, WEEE			
NOTE: Product specifications are subject to change without further notice. During storage, we recommend charging the UPS as per Table 6.2 on page 38 .				

Table 8.3 Specifications — EBCs

Model	GXE3-EBC24VRT2U	GXE3-EBC36VRT2U	GXE3-EBC48VRT2U	GXE3-EBC72VRT2U
UPS Compatibility	GXE3-1000IRT2UXL	GXE3-1500IRT2UXL	GXE3-2000IRT2UXL	GXE3-3000IRT2UXL
Battery Strings	2	2	2	2
DC Voltage	24 VDC	36 VDC	48 VDC	72 VDC
Capacity (Ah)	18 Ah	18 Ah	18 Ah	18 Ah
Dimension (D x W x H) mm	410 x 438 x 86 mm	410 x 438 x 86 mm	510 x 438 x 86 mm	630 x 438 x 86 mm
Net Weight (kg)	19 kg	24.3 kg	32 kg	44 kg
Environment				
Operation Humidity	5-95% RH at 0-40 °C (non-condensing)			
Operation Temperature	0 °C to 40 °C			
Storage Temperature	- 20 °C to 50 °C			
Elevation for Storage	0-15,000 m			
International Protection Code	IP20			
Agency				
Safety	EN/IEC 62040-1			
EMI/RFI/Immunity	EN/IEC 62040-2 EN/IEC 61000-3-2 EN 61000-3-3			
ESD	IEC/EN61000-4-2			
Radiated Susceptibility	IEC/EN61000-4-3			
Electrical Fast Transient	IEC/EN61000-4-4			
Surge Immunity	IEC/EN61000-4-5			

Table 8.3 Specifications — EBCs (continued)

Model	GXE3-EBC24VRT2U	GXE3-EBC36VRT2U	GXE3-EBC48VRT2U	GXE3-EBC72VRT2U
UPS Compatibility	GXE3-1000IRT2UXL	GXE3-1500IRT2UXL	GXE3-2000IRT2UXL	GXE3-3000IRT2UXL
Environmental	ROHS, REACH, WEEE			
Transportation	ISTA Procedure 2A			
Certification	CE, UKCA, RCM, Morocco, EAC, KC/KCC, TISI, SABER, RoHS, WEEE			

8.1 Battery Run Times

NOTE: The run times provided in these tables are approximate. These times are calculated based on new, fully charged standard battery modules at a temperature of 25 °C (77 °F) with 100% resistive UPS loading. The run times listed can vary by ±5% due to manufacturing variances.

Table 8.4 GXE3-1000IMT and GXE3-1500IMT — Run Times in Minutes

Load	GXE3-1000IMT (1000 VA)			GXE3-1500IMT (1500 VA)		
	%	Runtime	W	VA	Runtime	Load (W)
10	53.0	90	100	55.0	135	150
20	22.0	180	200	24.0	270	300
30	14.0	270	300	14.5	405	450
40	12.5	360	400	13.0	540	600
50	9.0	450	500	9.0	675	750
60	7.8	540	600	7.6	810	900
70	6.5	630	700	6.2	945	1050
80	4.2	720	800	4.5	1080	1200
90	3.6	810	900	4.1	1215	1350
100	3.1	900	1000	3.2	1350	1500

Table 8.5 GXE3-2000IMT and GXE3-3000IMT — Run Times in Minutes

Load	GXE3-2000IMT (2000 VA)			GXE3-3000IMT (3000 VA)		
	%	Runtime	W	VA	Runtime	Load (W)
10	56.0	180	200	59.0	270	300
20	26.0	360	400	29.0	540	600
30	14.6	540	600	15.8	810	900
40	13.8	720	800	13.7	1080	1200
50	9.0	900	1000	9.5	1350	1500
60	7.5	1080	1200	7.4	1620	1800
70	6.5	1260	1400	6.2	1890	2100
80	4.6	1440	1600	4.5	2160	2400
90	4.2	1620	1800	4.2	2430	2700
100	3.2	1800	2000	3.3	2700	3000

Table 8.6 GXE3-1000IRT2UXL — Run Times in Minutes

Load			Internal Battery	Number of EBCs (GXE3-EBC24VRT2U)			
				1	2	3	4
%	W	VA	Minutes				
10	90	100	53.0	161	269	377	485
20	180	200	22.0	92	176	238	349
30	270	300	14.0	56	104	155	208
40	360	400	12.5	46	96	138	196
50	450	500	9.0	38	70	103	139
60	540	600	7.8	35	65	93	137
70	630	700	6.5	30	57	85	115
80	720	800	4.2	26	48	74	99
90	810	900	3.6	23	43	65	88
100	900	1000	3.1	18	35	54	72

Table 8.7 GXE3-1500IRT2UXL — Run Times in Minutes

Load			Internal Battery	Number of EBCs (GXE3-EBC36VRT2U)			
				1	2	3	4
%	W	VA	Minutes				
10	135	150	55.0	167	279	391	503
20	270	300	24.0	97	179	242	351
30	405	450	14.5	57	106	156	213
40	540	600	13.0	47	98	140	199
50	675	750	9.0	39	72	106	143
60	810	900	7.6	36	66	94	138
70	945	1050	6.2	30	56	85	116
80	1080	1200	4.5	26	46	73	99
90	1215	1350	4.1	22	42	64	87
100	1350	1500	3.2	18	35	55	74

Table 8.8 GXE3-2000IRT2UXL — Run Times in Minutes

Load			Internal Battery	Number of EBCs (GXE3-EBC48VRT2U)			
				1	2	3	4
%	W	VA	Minutes				
10	180	200	56.0	170	284	398	512
20	360	400	26.0	99	182	246	359
30	540	600	14.6	58	108	157	215
40	720	800	13.8	46	99	141	201
50	900	1000	9.0	39	73	111	151
60	1080	1200	7.5	37	67	86	139
70	1260	1400	6.5	30	56	85	116
80	1440	1600	4.6	26	49	73	100
90	1620	1800	4.2	23	43	65	88
100	1800	2000	3.2	19	37	55	75

Table 8.9 GXE3-3000IRT2UXL — Run Times in Minutes

Load			Internal Battery	Number of EBCs (GXE3-EBC72VRT2U)			
				1	2	3	4
%	W	VA	Minutes				
10	270	300	59.0	179	299	419	539
20	540	600	29.0	102	188	252	363
30	810	900	15.8	61	116	168	221
40	1080	1200	13.7	49	101	147	206
50	1350	1500	9.5	42	78	115	155
60	1620	1800	7.4	36	66	87	136
70	1890	2100	6.2	29	55	84	113
80	2160	2400	4.5	25	47	71	98
90	2430	2700	4.2	22	42	63	86
100	2700	3000	3.3	19	36	56	76

This page intentionally left blank

Appendices

Appendix A: Technical Support and Contacts

A.1 Technical Support/Service in the United States

Vertiv Group Corporation

24x7 dispatch of technicians for all products.

1-800-543-2378

Liebert® Thermal Management Products

1-800-543-2378

Liebert® Channel Products

1-800-222-5877

Liebert® AC and DC Power Products

1-800-543-2378

A.2 Tower and Rack/Tower UPS

In Europe, Middle East, and Asia

EMEA Multi-language technical support

Email: eoc@vertiv.com

Phone: Toll free 0080011554499

Phone: Toll +39 02 98250222

In Latin America

In Peru

Email: call.center@vertiv.com/suporte.vertiv2@connectcom.com.br

Phone: 0800-77737

In Chile

Email: callcenter.chile@vertiv.com

Phone: 800-395429

In Argentina

Email: ar.servicios@vertiv.com

Phone: 0800-1220869

In Columbia

Email: callcenter.colombia@vertiv.com

Phone: 018000-125527

In Mexico

Email: callcenter.mexico@vertiv.com

Phone: 01800-2530414

In Central America and Caribbean countries

Email: callcenter.CA@vertiv.com

A.3 Locations

United States

Vertiv Headquarters
505 N Cleveland Ave
Westerville, OH 43082

Europe

Via Leonardo Da Vinci 8 Zona Industriale Tognana
35028 Piove Di Sacco (PD) Italy

Asia

7/F, Dah Sing Financial Centre
3108 Gloucester Road, Wanchai
Hong Kong

Appendix B: Open Source Software Legal Notices

The Vertiv™ Liebert® GXE product links the FreeRTOS software with Vertiv Group Corporation's proprietary modules that communicate with the FreeRTOS software solely through the FreeRTOS API interface. This use is an exception to the FOSS GPLv2 license. The user is free to redistribute the FreeRTOS software and/or modify it under the terms of the GNU General Public License as published by the Free Software Foundation. A copy of the GNU General Public License is located at www.gnu.org/licenses/old-licenses/gpl-2.0.html. A copy of the exception is located at <https://spdx.org/licenses/freertos-exception-2.0.html>. For a period of three (3) years after purchasing the GXE product, the purchaser has the right to obtain a copy of the FreeRTOS software that is incorporated in the GXE product. The purchaser can contact Vertiv Technical Support and request the software.

This page intentionally left blank

Connect with Vertiv on Social Media



<https://www.facebook.com/vertiv/>



<https://www.instagram.com/vertiv/>



<https://www.linkedin.com/company/vertiv/>



<https://www.twitter.com/Vertiv/>



Vertiv.com | Vertiv Headquarters, 505 N Cleveland Ave, Westerville, OH 43082 USA

©2024 Vertiv Group Corp. All rights reserved. Vertiv™ and the Vertiv logo are trademarks or registered trademarks of Vertiv Group Corp. All other names and logos referred to are trade names, trademarks or registered trademarks of their respective owners. While every precaution has been taken to ensure accuracy and completeness here, Vertiv Group Corp. assumes no responsibility, and disclaims all liability, for damages resulting from use of this information or for any errors or omissions.

SL-71224_REVA_04-24