







VEVOR

Upgrade · The Home Creator Way

FENCE POSTS (METAL)

Model:10-3FT/10-4FT/10-5FT/6-6FT/10-6FT/10-7FT

VEVOR Support Center

1	10-3FT		2	10-4FT	
3	10-5FT		4	6-6FT	
5	10-6FT		6	10-7FT	

Model:10-3FT/10-4FT/10-5FT/6-6FT/10-6FT/10-7FT

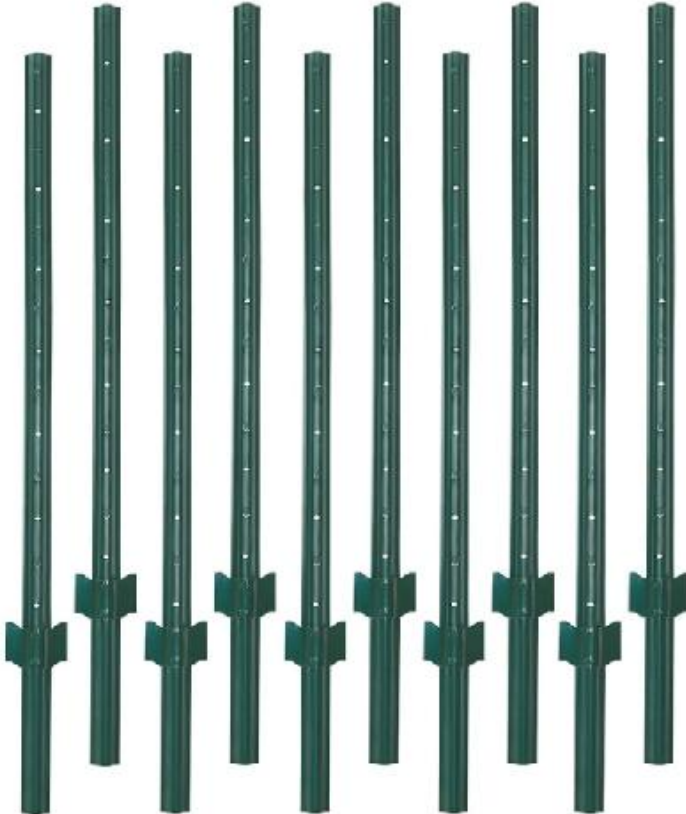

This is the original instruction, please read all manual instructions carefully before operating. VEVOR reserves a clear interpretation of our user manual. The appearance of the product shall be subject to the product you received. Please forgive us that we won't inform you again if there are any technology or software updates on our product.

Safety precautions

WARNING:

Read this instructions before using this product. Failure to do so can result in serious injury. the basic precautions should always be followed,including the following:

1. The fence posts may not be used or stored in hazardous areas. It is not allowed to use the appliance in hazardous locations.
2. The fence posts must be checked to ensure that it is in proper working order and is operating safely prior to use. Otherwise,the appliance must not be used.
3. Use as intended only. The fence posts is not suitable for sweeping off corrosive substances. as they can harm the materials on the fence posts.
4. The operator must use the fence posts properly. He must consider the local conditions and must pay attention to third parties,in particular children,when working with the fence posts.
5. This fence posts is not intended for use by persons (including children) with reduced physical,sensory or mental abilities or lacking experience and/or knowledge,unless they are super-vised by a person responsible for their safety or are instructed by these persons on the use of the device. Children should be supervised,to ensure that they do not play with the fence posts.

SAVE THESE INSTRUCTIONS

Product Description

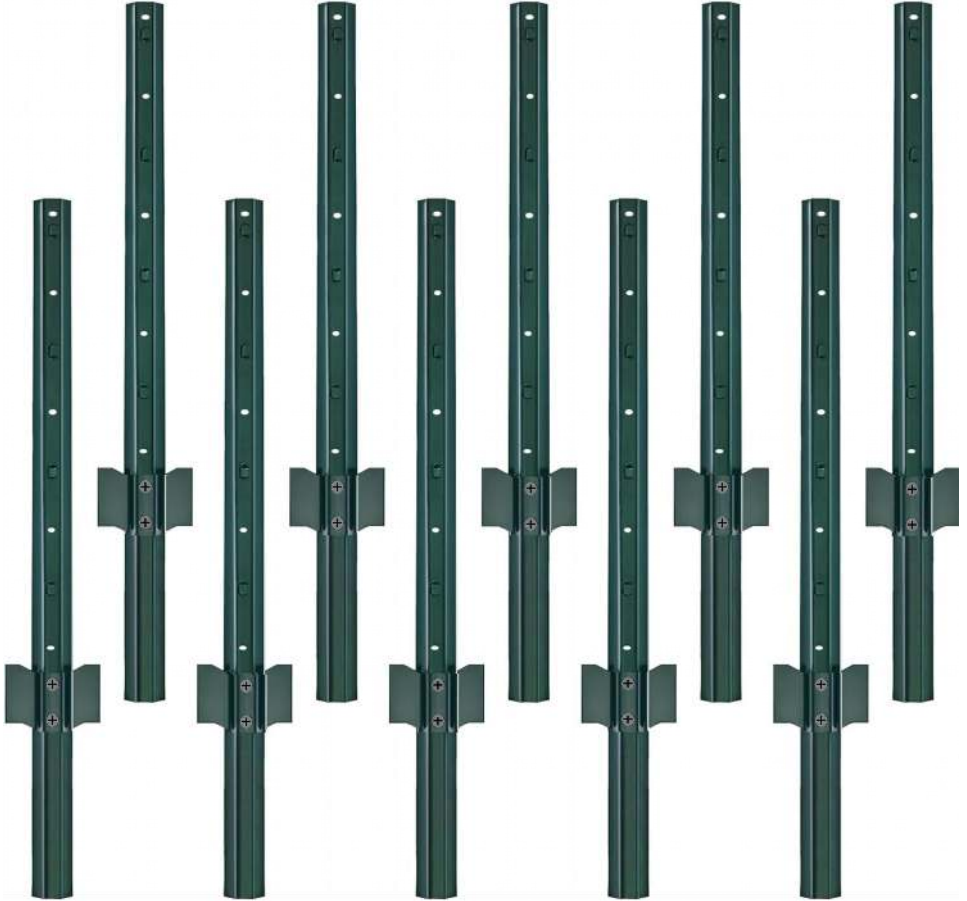

Model	Spec (Ft)	No. of sets	No. of Plastic cable ties	No. of Metal hooks	No. of Screws
10-3FT	3	10	20	20	20
10-4FT	4	10	20	20	20
10-5FT	5	10	30	20	20
6-6FT	6	6	24	12	12
10-6FT	6	10	40	20	20
10-7FT	7	10	50	20	20

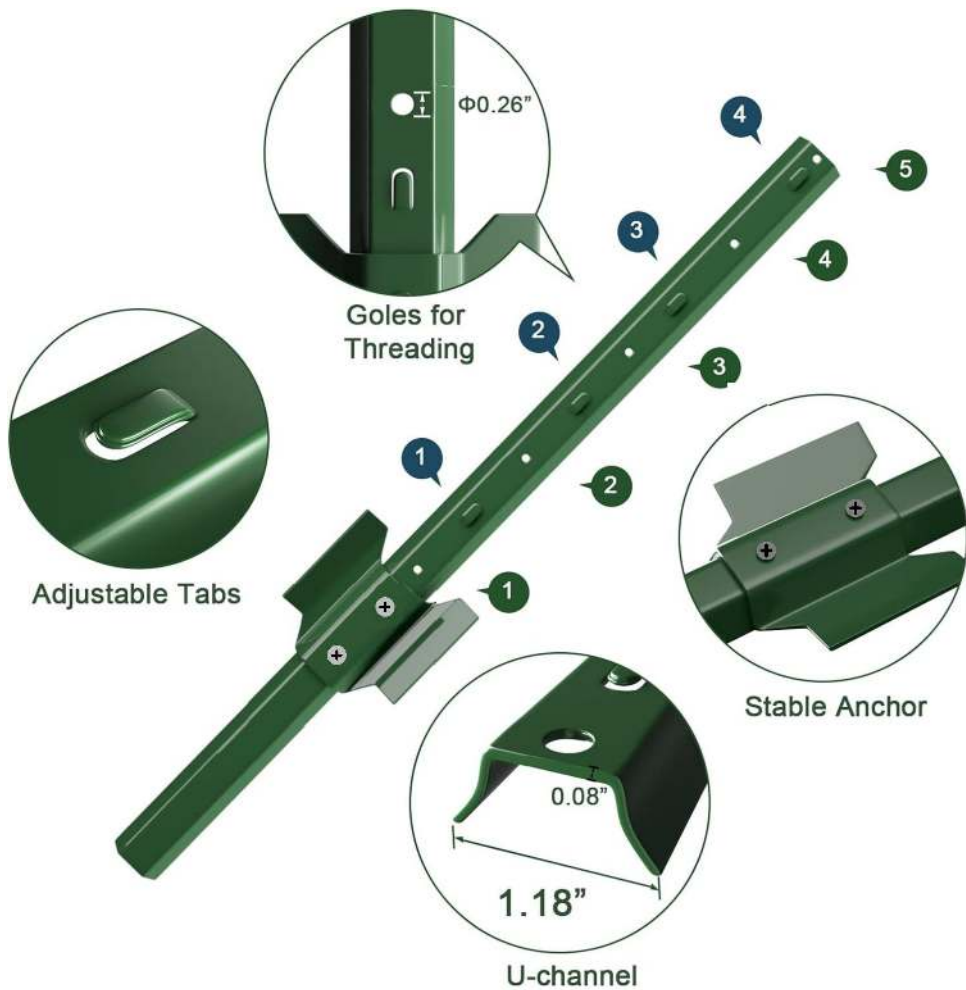

Adjustable Tabs

Holes for Threading

Stable Anchor

U-channel



Plastic cable ties



Metal hooks



Screws

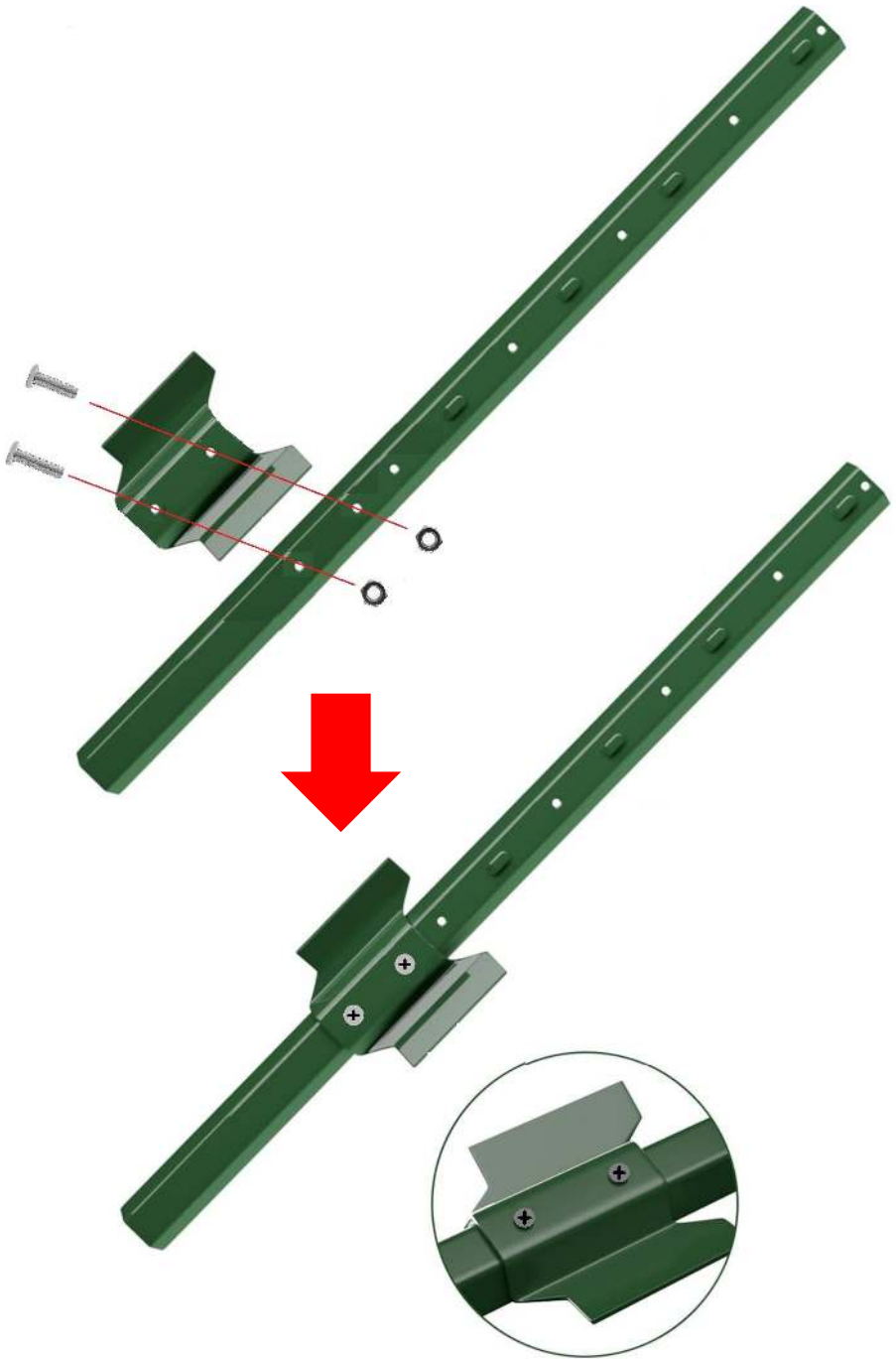

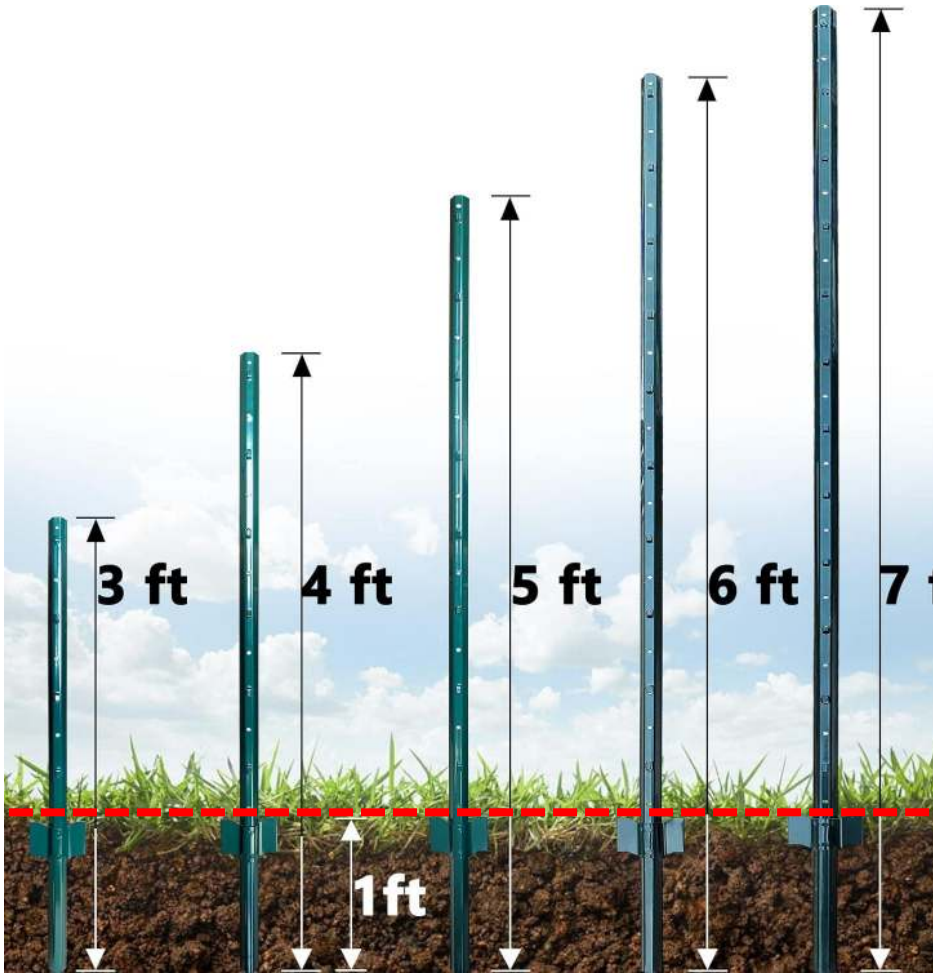

Note: The stable anchor must be fully inserted into the soil in order to be stable.

Multi-Use

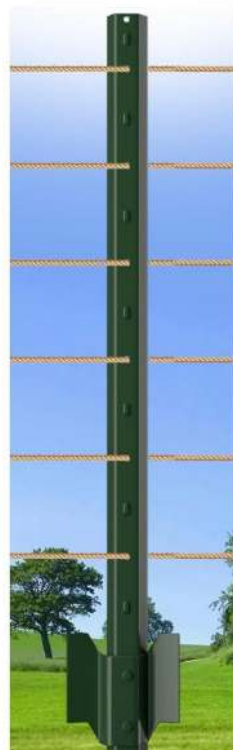
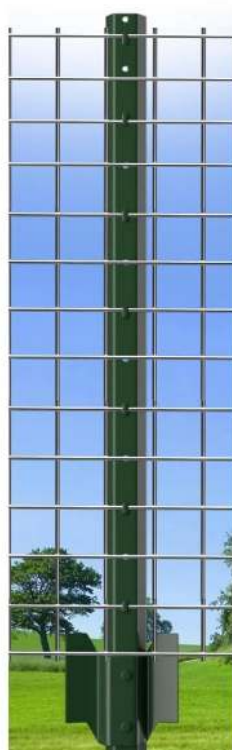
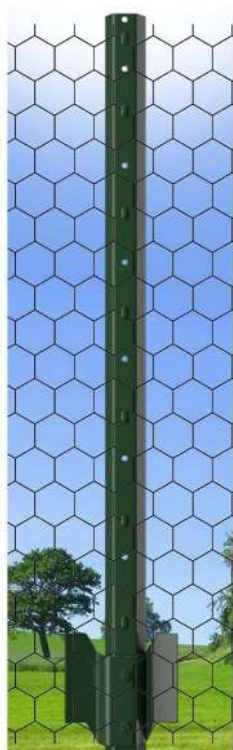



Orchard



Garden

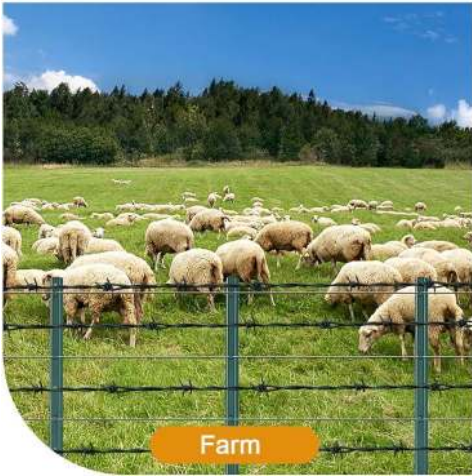

Farm



Road

Manufacturer: Shanghaimuxinmuyeyouxiangongsi

Address: Shuangchenglu 803nong11hao1602A-1609shi, baoshanqu, shanghai 200000 P.R. China

E-mail: support@vevor.com

Imported to AUS: SIHAO PTY LTD. 1 ROKEVA STREETEASTWOOD NSW 2122 Australia

Imported to USA: Sanven Technology Ltd. Suite 250, 9166 Anaheim Place, Rancho Cucamonga, CA 91730

EC REP: E-CrossStu GmbH.

Mainzer Landstr.69, 60329 Frankfurt am Main.

e-crossstu@outlook.com +49 69332967674

UK REP: YH CONSULTING LIMITED.

C/O YH Consulting Limited Office 147, Centurion House, London Road, Staines-upon-Thames, Surrey, TW18 4AX

H2YHUK@gmail.com +44 07514-677868

