

IPC 113v2

# Smart Security Wi-Fi Cam

## User Manual



# VIVITAR®

© 2009-2018 Sakar International, Inc. All rights reserved.

Windows and the Windows logo are registered trademarks of Microsoft Corporation.

All other trademarks are the property of their respective companies.

# TABLE OF CONTENTS

---

- Introduction ..... 2
- Features ..... 2
- What’s Included ..... 3
- Parts of the Camera ..... 4
- Initial Camera Setup ..... 5
  - INSTALLING THE MEMORY CARD ..... 5
  - TURNING ON THE SMART SECURITY CAM..... 6
  - CAMERA RESET ..... 7
  - INDICATOR LIGHT ..... 8
- Initial Mobile Device Setup ..... 9
  - MOBILE DEVICE – ANDROID AND IOS SYSTEM REQUIREMENTS ..... 9
  - VIVITAR SMART HOME SECURITY – INSTALL AND LAUNCH ..... 9
- Connecting Your IP Camera with the Vivitar Smart Home Security Mobile Application ..... 10
  - INTRODUCTION ..... 10
  - QUICK OVERVIEW ..... 11
  - INITIAL SETUP: CONNECTING YOUR CAMERA TO THE APP..... 12
- Using Vivitar Smart Home Security ..... 19
  - LIVE IP CAMERA VIEW ..... 19
  - MAIN MENU..... 23
  - NAVIGATION BAR ..... 49
  - IP CAMERAS SCREEN ..... 50
  - DEVICES ..... 53
  - SHARING IP CAMERAS..... 56
  - RECONNECTING DEVICES ..... 60
  - HOME AND AWAY MODES ..... 65
  - FULL SCREEN LIVE STREAMING VIDEO MODE..... 67
- Using your Device with Amazon Alexa ..... 69
- Using your Device with Google Actions ..... 71
- Troubleshooting ..... 74
- Camera Technical Specifications ..... 77
- Technical Support ..... 77
- Sakar Warranty Card ..... 78

## Introduction

Thank you for purchasing your Vivitar IPC 113v2 Smart Security Cam.

Everything you need to stream live video, record in HD and capture still images and videos remotely is included with your camera and the accompanying online Vivitar 'Smart Home Security' application.

You can use the app to monitor what is going on inside and outside your home via any mobile device from anywhere. There is automatic activation of all IP cameras based on motion and sound detection. In addition, you can use the 'Smart Home Security' app to control your lighting, doorbell, electrical outlets and more.

Please read this manual carefully first in order to get the most out of your Vivitar Smart Security Cam.

NOTE:

Your Smart Security Cam requires a Class 4 or higher Micro SDHC memory card up to 32 GB. Micro SD Memory cards are not included and need to be purchased separately.

## Features

- Stream Live Video
- Still Image Capture
- Record in HD
- IR Night Vision
- Motion Detection
- Wireless Wi-Fi Connectivity
- Two-way Intercom
- Built-in Speaker/Microphone
- Built-in Light Sensor
- Vivitar Smart Home Security app: Free Mobile App for iOS and Android smartphones or tablets

# What's Included



②



③

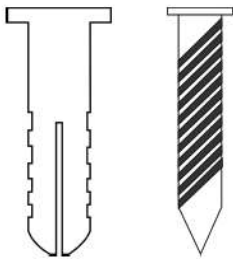
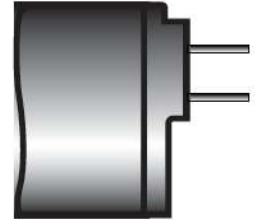

⑤



1. IP Camera
2. Micro USB cable
3. AC Charger
4. Screws
5. Setup Tool

NOTE: Micro SD Memory Card not included.

# Parts of the Camera

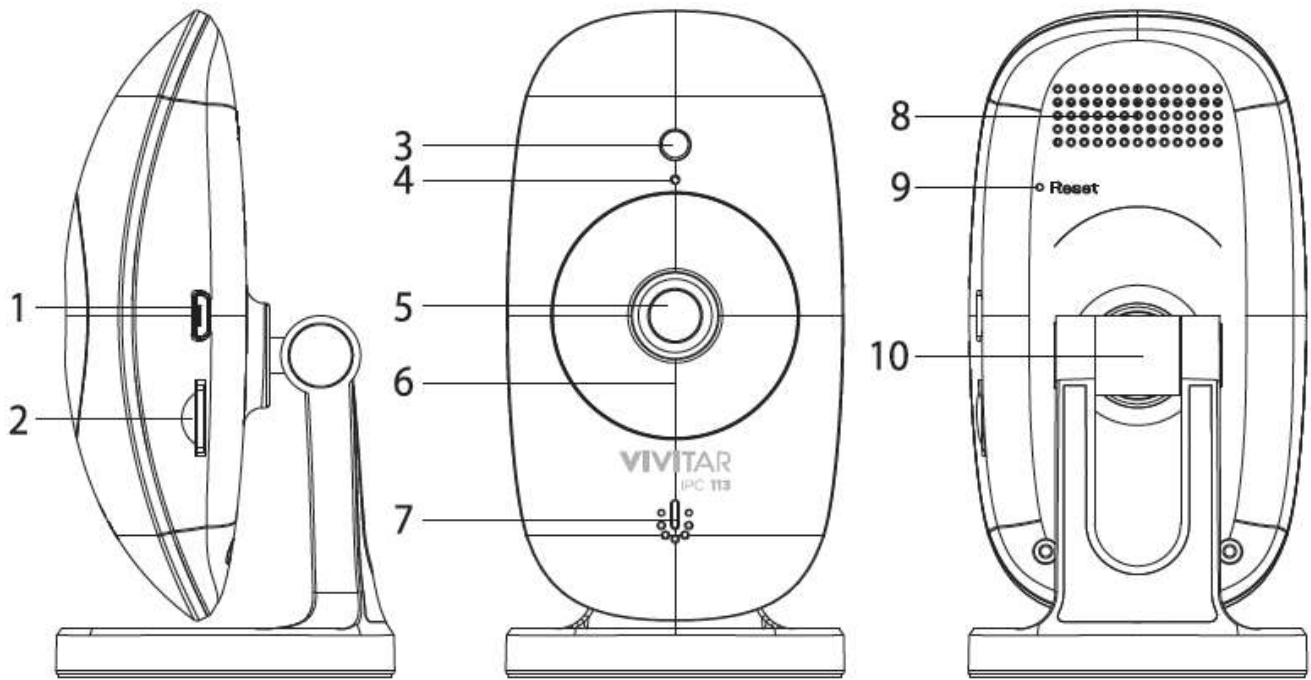

- |                              |  |
|------------------------------|--|
| 1. Micro USB Port            | 6. LED Status Light Indicator (Red/Blue) |
| 2. Micro SD Memory Card Slot | 7. Speaker                               |
| 3. Light Sensor              | 8. Ventilation Holes                     |
| 4. Microphone                | 9. RESET                                 |
| 5. Lens                      | 10. Column Spinner                       |

# Initial Camera Setup

## INSTALLING THE MEMORY CARD

---

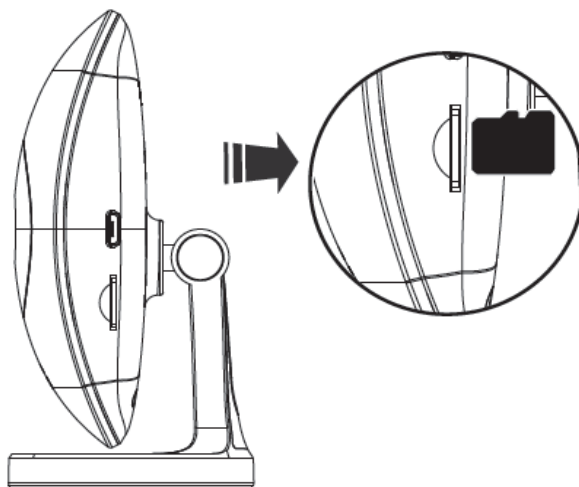

Make sure a Micro SD Memory card (Class 4 or higher, up to 32 GB) has been properly inserted into your Smart Security Cam. Micro SD Memory card not included and must be purchased separately. To properly insert the Micro SD Memory Card:

1. Insert the Micro SD memory card into the Micro SD Card slot as shown in the illustration above.
2. Gently press the Micro SD Card until you hear a slight clicking sound.  
This indicates the memory card has been inserted correctly.

**NOTE:** Make sure to insert the Micro SD Memory card before plugging in your device.

## TURNING ON THE SMART SECURITY CAM

---

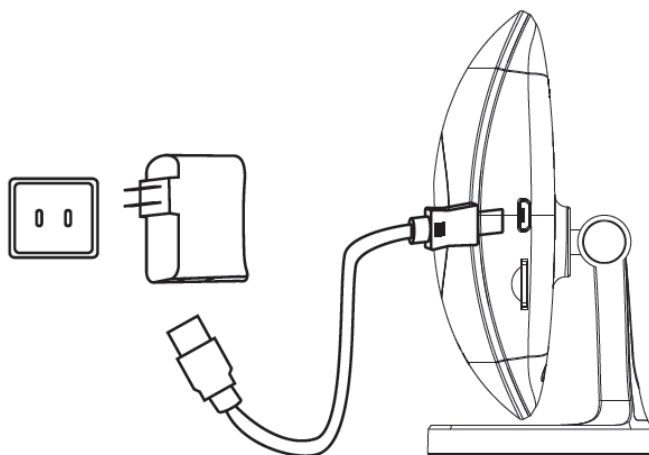

Connect one end of the Micro USB cable to your IP camera and the other end to the AC charger and then plug the AC charger into a power socket. The RED indicator light turns on.

### NOTE:

If the camera indicator is blinking blue, the camera needs to be reset. See the section below, [Camera Reset](#), for further information.

The LED power light indicator blinks blue after about one minute, indicating that the camera is powered on. To power off the camera, disconnect the USB cable from the power source.

## CAMERA RESET

---

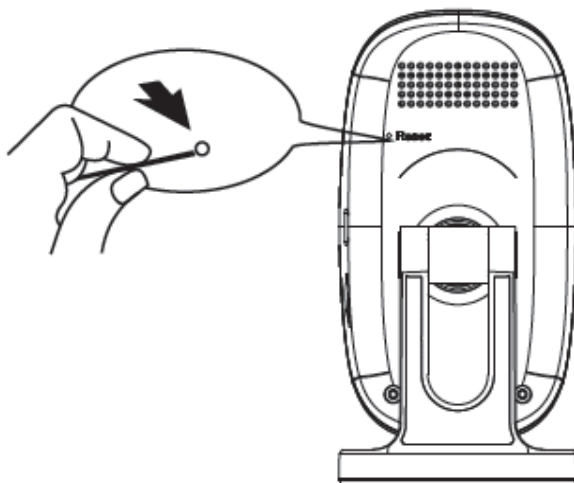

If the camera indicator is blinking blue upon startup, the camera needs to be reset.

To reset the IP Camera:

1. Use the Setup Tool (supplied) or a small pin to press the RESET button (hole) on the back of the camera.
2. Press and hold until the LED light indicator turns red. Release the RESET button and wait for the system to reboot. This will take about 15 seconds. You will hear the camera emit 'Reset Success'.

## INDICATOR LIGHT

---



### **Red Flashing Indicator Light:**

When the red indicator light is flashing, this indicates that the camera is in setting mode and it is ready for Wi-Fi setup via your mobile device.

### **Blue Steady Indicator Light:**

When the blue indicator light is steady, this indicates that the camera is connected to Wi-Fi.

### **Blue Flashing Indicator Light:**

When the blue indicator light is flashing, this indicates that the camera may need to be reset if it does not connect to your device while adding a new device or reconnecting a device.

# Initial Mobile Device Setup

## MOBILE DEVICE – ANDROID AND IOS SYSTEM REQUIREMENTS

---

- Android cellphone/tablet with OS 4.4 or higher
- iPhone/iPad with iOS 9.0 or higher

## VIVITAR SMART HOME SECURITY – INSTALL AND LAUNCH

---

1. Make sure your mobile device is connected to a Wi-Fi Network via the Settings of your mobile phone or tablet.
2. Use your mobile phone or tablet to search for **Vivitar Smart Home Security** in the Google Play Store (for Android OS) or the Apple App Store (for iOS).  
Alternatively, scan the QR codes below to find the application.

**Android OS**

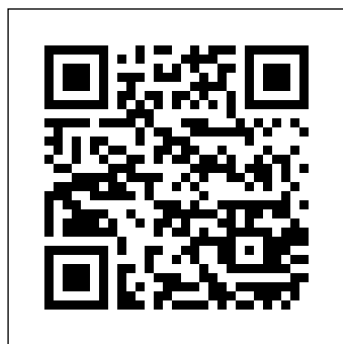

**iOS**

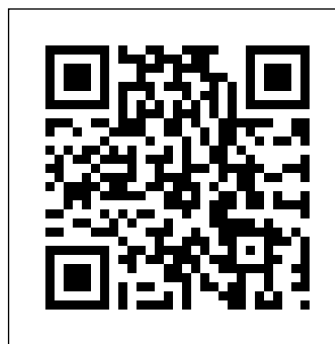

3. Install the application according to the instructions as seen on your mobile device.
4. After successfully installing **Vivitar Smart Home Security**, tap the icon to launch the application.



# Connecting Your IP Camera with the Vivitar Smart Home Security Mobile Application

## INTRODUCTION

---

The Vivitar Smart Home Security application allows you to easily connect and control your lighting, indoor and outdoor IP Cameras, electric outlets and more via any mobile device from anywhere.

With Vivitar Smart Home Security, you can see what is going on in and outside your home 24 hours a day, 7 days a week. Receive automatic alerts from your IP Cameras upon detection of motion and sound. Set on/off schedules for each smart light bulb or outlet and more with automatic adjustments for sunrise/sunset.

- Motion Detection/Event Notification
- 2-Way Intercom (speaker/listen)
- Free Cloud Storage
- Night View, using the Infrared Video Mode
- Easily connects to your smart phone or tablet
- Home, Baby and Pets Monitoring
- Connect multiple IP Cameras

### IP Camera: Home Mode

- Monitor your home via any mobile device from anywhere.
- IP Cameras have full duplex intercom capabilities.

### IP Camera: Away Mode

- Receive automatic alerts from your IP Camera based on motion and sound detection.
- Telepresence notification to any mobile device.
- Alerts to police, emergency services, and your selected list of contacts when motion or sound is detected.

# QUICK OVERVIEW

---

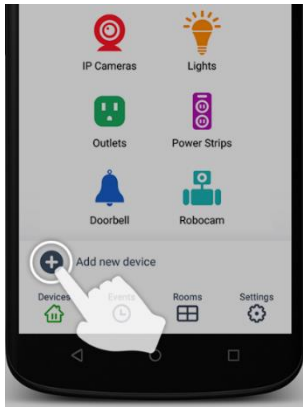

**ADD NEW VIVITAR SMART HOME DEVICES**  
Tap the 'Add new device' button on the Home screen and follow the instructions to add your new device.

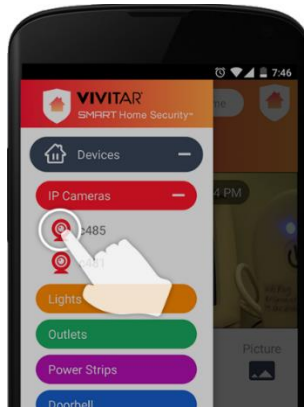

**CONTROLS ALL VIVITAR SMART HOME DEVICES**  
Tap the 'Main Menu' button to easily navigate to all the main functions of the app. Tap 'Devices' to control your smart lights, indoor and outdoor IP cameras, electric outlets and more.

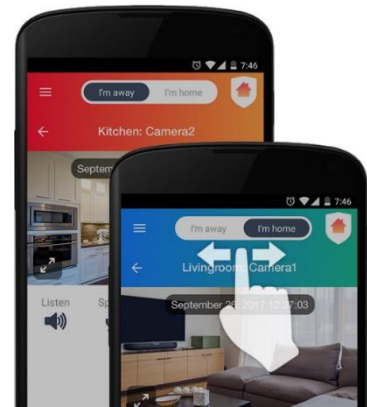

**HOME & AWAY MODES**  
Switch the Home & Away modes when you leave your home and when you come back to automatically adjust all the devices' security settings in your home.

## INITIAL SETUP: CONNECTING YOUR CAMERA TO THE APP

---

### NOTE:

- Your IP Camera is supported only on a 2.4GHz Wi-Fi Network. Before setup, please make sure your mobile device is connected to a 2.4GHz Wi-Fi Network.
- Please follow the steps below to create your User Account. You must be logged into your User Account to register and use your IP Camera.

### INITIAL CAMERA AND DEVICE SETUP:

#### 1. ENABLE MOBILE DEVICE WI-FI

Make sure to enable Wi-Fi on your smartphone or tablet via the settings of your mobile device.

#### 2. LAUNCH MOBILE APP

If you have not already launched the app, tap the  **Vivitar Smart Home Security** application icon on your smartphone or tablet to launch the installed app.

#### 3. TUTORIAL

A [quick overview](#) through the app appears.

Scroll through the pages to view the tutorial or tap **Skip** to continue the initial setup.

NOTE: A window appears during the quick overview regarding the permission of receiving Notifications, such as sounds, icon badges, alerts. Tap **Allow** to allow the “Smart Home Security” app to send you notifications. This can be configured later via your phone settings.

#### 4. END USER LICENSE AGREEMENT

The End User License Agreement screen appears. Tap **Agree & Continue** to enter the ‘Devices’ Home screen and continue to the initial registration and adding your device.

## 5. INITIAL REGISTRATION – IP CAMERAS ACCOUNT

You must create a new IP Cameras Account or sign in to your existing account to use your device. To register and add a new IP Camera:

- 1) From the 'Devices' Home screen, tap  **Add New Device** to enter the 'Add new device' screen.

The list of Vivitar Smart Home Security devices appears.

- 2) Tap  **IP Cameras** to enter the list of Vivitar IP Cameras.

- 3) Tap  **IPC-113v2 Smart Security Wi-Fi Cam** to select and register your IPC 113v2 camera.

NOTE: Alternatively, you can select your IP Camera and continue to the registration by scanning in the barcode on the back your camera. Tap **Scan Barcode** located on the bottom of the first 'Add new device' screen that lists the Smart Home devices.

- 4) The 'Register a new device' screen appears.

You can create a new account or if you have already created an account, you can sign in to your existing account.

NOTE: If you select 'Cancel' without signing in or creating a new account, you will not be able to access your IP Camera via the app.

### a) Create a New Account:

Tap **Register** to create a new Smart Home Security account.

You will be prompted to enter your email and a password for this account.

A registration verification code is sent to your email. You will then be prompted to enter this verification code in the app. Enter the code then tap **Verify** to complete your new account registration.

NOTE: You may be prompted to sign into your account to begin using your camera after camera connection.

### b) Sign in to Existing Account:

To sign in to your existing Smart Home Security account, tap **Sign In** from the 'Register a new device' screen.

Enter your email, your account password and then tap **Sign In**.

## 6. ADD NEW DEVICE

The 'Add Device' instruction screen then appears.

### 1) MAKE SURE YOUR CAMERA'S LED LIGHT IS BLINKING RED

Plug in your camera and wait a moment.

When the red LED light is blinking, tap **Continue**.

NOTE: The camera's Wi-Fi can only be found when the camera's LED indicator light is red and is flashing. If you do not see this, then the camera will need to be reset. Please follow these steps:

TO RESET YOUR CAMERA:

- Use the Setup tool (supplied) or a small pin to push and hold the 'Reset/Set' button (hole) found on the back of the camera.
- Release the pin once you hear the camera emit 'Reset Success'.
- Wait a few moments until the red LED light starts blinking, then tap **Continue**.

### 2) CONFIGURE NETWORK

The 'Configure Network' screen appears.

The name of the Wi-Fi network that your phone is connected to automatically appears.

Enter the Wi-Fi password and then tap **Continue**.

### 3) CONNECTING

The 'Connecting' screen appears displaying the connection progress. Please wait for the indication that the camera has successfully been found and connected.

NOTE: The camera will emit the following once connected: 'Wi-Fi Connect Success. Internet Connected. Welcome using Cloud Camera'.

### 4) ADD CAMERA NAME AND LOCATION

The 'Add to Account' screen then appears displaying the camera image along with the model name and UID number.

Enter the following details for your IP Camera:

- Set Name: Enter a name for your camera.
- Set Room: Tap to view the list of room names and select the appropriate room.

After setting your camera name and room, tap **Done**.

## 7. CLOUD SUBSCRIPTION:

A message window then appears notifying you that your device has been added successfully. Tap **Cloud Subscription** to view your Cloud storage options or tap **Next** to proceed without subscribing to the Cloud Service. Note that you can subscribe at any time via the device's Settings.

Once you have either tapped **Next** or completed your **Cloud Subscription**, your added IP Camera can now be viewed in the Live IP Camera view.

### ***CLOUD SUBSCRIPTION PROCESS:***

1) Tap **Cloud Subscription** on the message window.

The 'Cloud Subscription' screen then appears.

The Cloud Video Recording Subscription allows you to:

- Automatically Store Video: Automatically save your recording of the last 14 days.

NOTE: During your 60-day free trial, the recordings of the last 7 days are saved and stored.

- Video Alarm Notifications: Receive alarm notifications (sound detection/motion detection)
- Secure Data: Save and secure your data on the cloud storage.
- View and playback your saved events via the app.

2) To begin your Cloud Subscription, tap **60 days cloud service free trial**.

3) The payment options for your Cloud Subscription appears. Follow the steps for payment completion.

NOTE: There is no charge for the first 60 days. After the 60 days free trial has ended, you will be charged \$5/month.

4) Once completed, a Cloud Subscription Confirmation screen appears. Tap the **Back** button to continue.

NOTE: You will also receive an email confirmation.

**IMPORTANT:** After your free trial Cloud Subscription is confirmed you will have a 24/14 Recording Subscription. Your 60 days free Cloud Service trial begins immediately after you have successfully subscribed. It may take up to 15 minutes for the Cloud Subscription to take effect. Once the trial period is complete, you will be charged \$5 on a monthly basis as per the date of your initial payment of each month. Your Cloud Subscription can be cancelled at any time.

***CONTINUING SETUP WITHOUT THE CLOUD SUBSCRIPTION:***

Tap **Next** on the message window to proceed to the Devices screen/Live IP Camera Mode screen without subscribing to the Cloud Storage.

NOTE: If you choose to skip the Cloud Subscription, you can access the Cloud Subscription at any time from the selected camera's settings. A Cloud Subscription is required to playback your recorded cloud events.

## INITIAL REGISTRATION AND ADDING A DEVICE

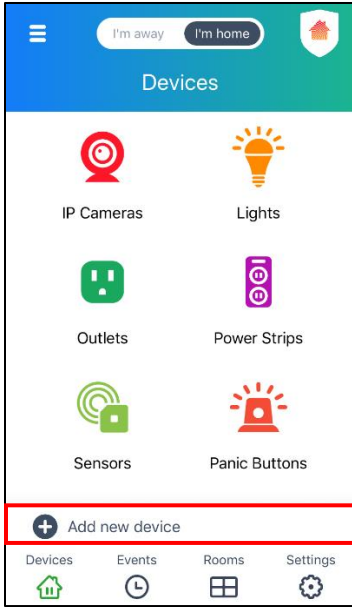

1. Devices: Tap **Add device**

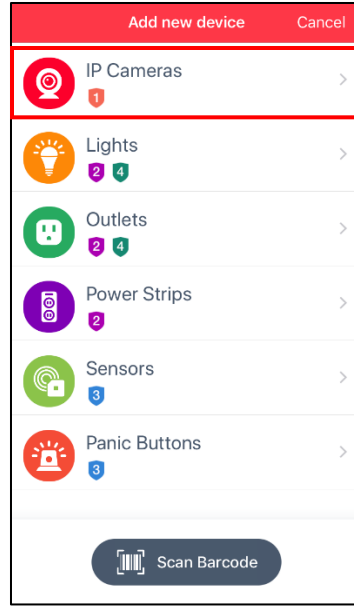

2. Tap **IP Cameras**



3. Tap your **IP Camera**

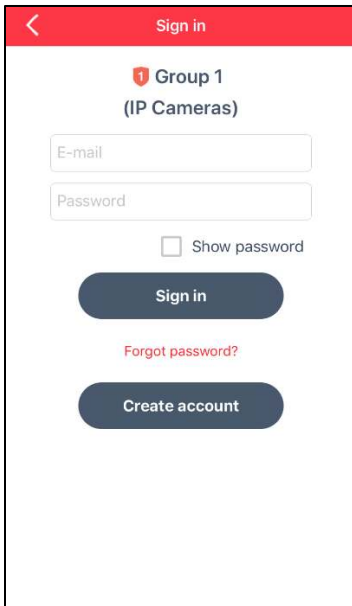

4. Tap **Register** or **Sign In** and follow the instructions

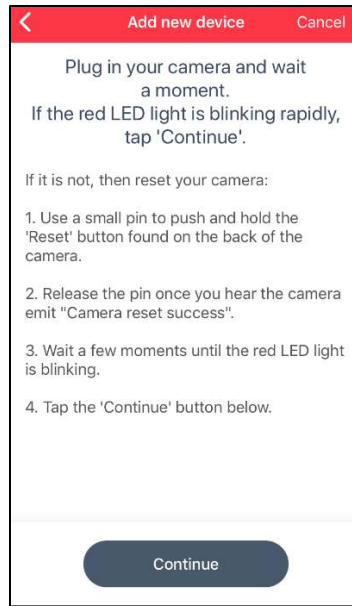

5. Follow the Add Device instructions then tap **Continue**

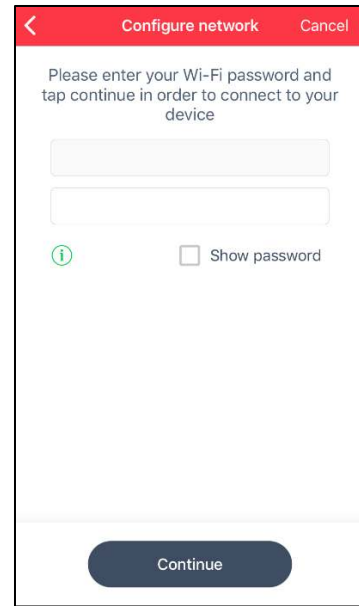

6. Enter Wi-Fi password then tap **Continue**



6. Connecting screen

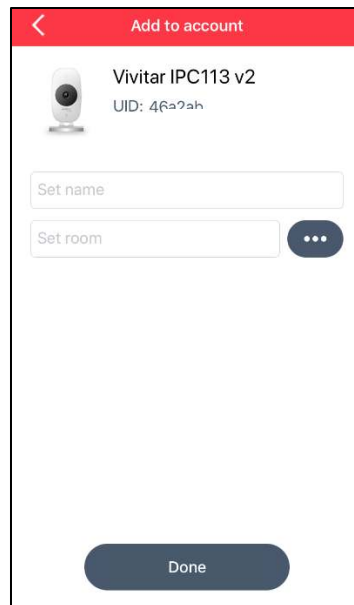

7. Enter camera name and tap **Set Room** to select location, then tap **Done**.

**NOTE:** The **Cloud Subscription** window then appears.

Follow the prompts to subscribe.

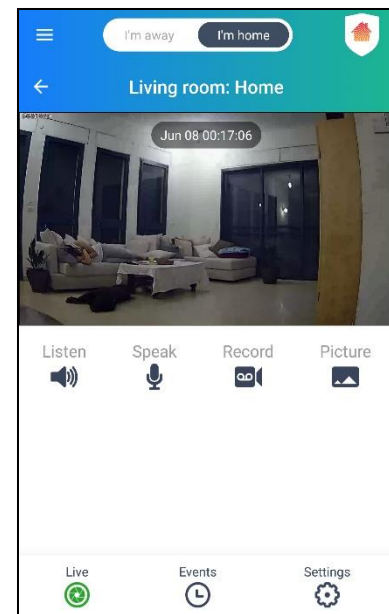

8. Enter Live IP Camera View

**NOTE:**

- After initial setup and after connecting additional IP Cameras, the 'Devices' home screen appears. Tap **IP Cameras** to view the list of your connected IP Cameras. Then tap on a video thumbnail view to open the selected camera in the 'Live IP Camera' view.
- When re-launching the app, the 'Devices' home screen appears by default.

# Using Vivitar Smart Home Security

## LIVE IP CAMERA VIEW

The **Live IP Camera** view displays the live streaming video of your selected registered IP Camera and camera options. You must be signed in and connected

NOTE:

- You must be logged in to your account in order to view your camera's streaming video.
- To view your camera's Events, please sign into or sign up for a Cloud Subscription.

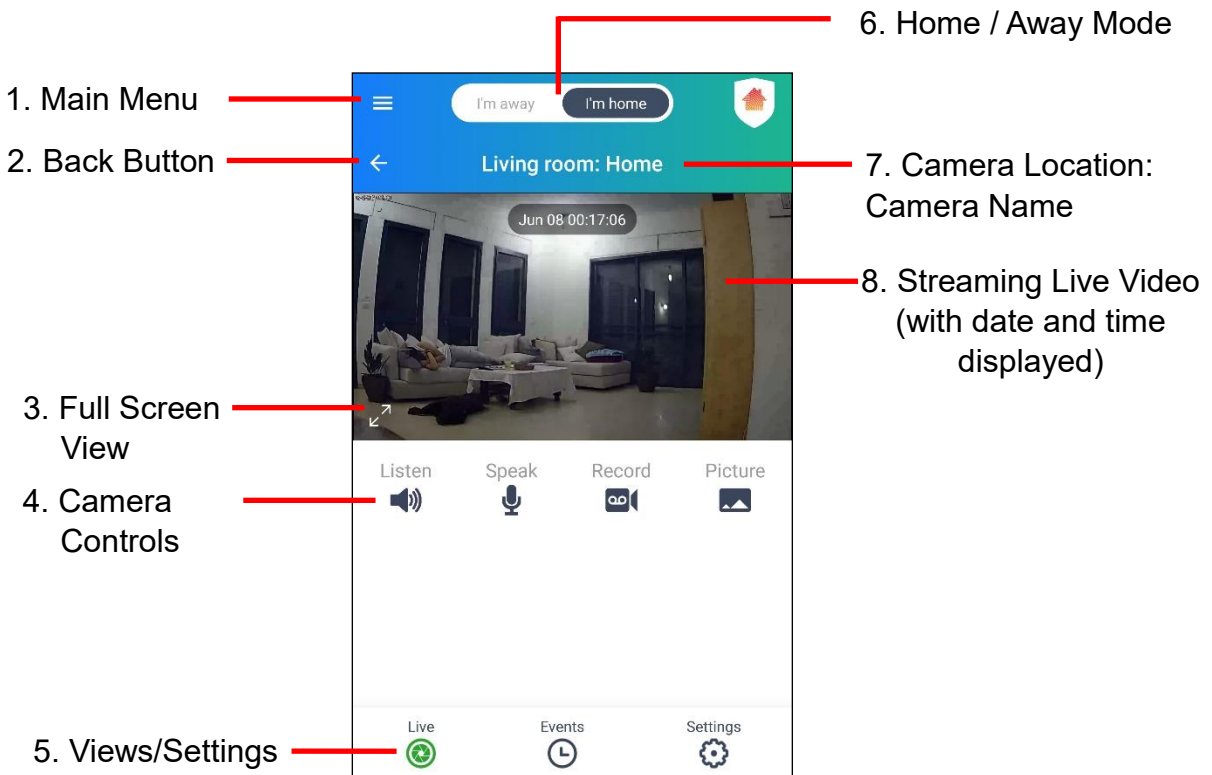

The connected camera displays the following:

ITEM	NAME	FUNCTION
1	<b>Main Menu</b>	Displays the Main Menu options: Devices, Events, Rooms, Settings, Accounts, Help
2	<b>Back Button</b>	Tap to go back to the previously viewed screen.
3	<b>Full Screen View</b>	Tap the arrows to switch between streaming video display in portrait view and Full Screen Landscape view.
4	<b>Camera Controls (Manual)</b>	Tap to activate the selected option(s): Listen, Speak, Record, Picture NOTE: These options can be used simultaneously.
5	<b>View / Settings</b>	Tap to change between Live View, Events View or Camera Settings.
6	<b>Away / Home Mode</b>	Tap to toggle between the Away and Home Modes
7	<b>Camera Location: Camera Name</b>	Displays the camera name and room name you entered during the setup. NOTE: You can change the names at any time via the Camera 'Settings'.
8	<b>Live Camera View</b>	Streaming Video of your selected camera is shown, with the date and time.

## LIVE IP CAMERA VIEW: OPTIONS

-  **Main Menu:**

Tap the Main Menu button to open the list of menu options:

Devices, Events, Rooms, Settings, Messages, Share, Accounts, Help

Please see the [Main Menu](#) section for more information.

-  **Home and Away:**

Tap **I'm away** or **I'm home** at the top of the screen to switch between Home Mode and Away Mode. Remember to adjust when you leave your home and when you come back to

automatically adjusts all your devices security settings in your home.

Please see the [Home and Away Modes](#) section for more information.

- **← Back:**

Tap the Back button to go back to the previous screen.

-  **Full Screen:**

Tap the Full Screen button to view the Live Streaming Video in full screen (landscape view).

Please see [Full Screen Live Streaming Video Mode](#) for more details.

-  **Listen:**

Tap the Listen button to enable or disable listening to the incoming sound from your IP Camera. The 'Listen' button turns green when enabled and the sound from the streaming video can be heard.

NOTE: The app needs access to your microphone in order to use the 'Listen' function.

Please make sure to tap **OK** when the message appears to allow access to your device's microphone.

-  **Speak:**

Tap the Speak button to enable or to disable speaking via the Vivitar Smart Home Security app on your mobile device and having that sound emit through your IP Camera. The 'Speak' button turns green when enabled.

NOTE: The app needs access to your microphone in order to use the 'Speak' function.

Please make sure to tap **OK** when the message appears to allow access to your device's microphone.

-  **Record:**

Tap the Record button to start recording a video from the live stream. Tap again to stop recording. The video is saved to your mobile device's Photos app. The 'Record' button turns green when enabled and a blinking, red record icon appears on streaming live video. The elapsed recording time is also displayed.

NOTE: The app needs access to your photo library in order to save recorded videos. Please make sure to tap **OK** when the message appears to allow access to your mobile device's photos.

-  **Picture:**

Tap the Picture button to take a picture from the live stream. The picture is saved to your mobile device's Photos app. The 'Picture' button turns green when in use.

NOTE: The app needs access to your photo library in order to save captured photos. Please make sure to tap **OK** when the message appears to allow access to your mobile device's photos.

- **Bottom Navigation Bar Buttons:**

-  **Live:** Tap **Live** to return to the selected Live IP Camera Mode.

-  **Events:** Tap **Events** to view the 'Events' screen for the selected device.

-  **Settings:** Tap **Settings** to view the 'Settings' screen for the selected device.

NOTE: The navigation bar button appears green when in the selected view.

The following features can work simultaneously: Listen, Speak, Record, Picture.

# MAIN MENU

---



Tap the **Main Menu** button to view the following menu options:

**Devices +, Events, Rooms, Settings, Messages, Share, Accounts +, Help**

Tap on one of the menu items to view the selected menu's options.

NOTE: All menu options that appear with a **+ plus symbol** can be expanded when tapping on the **+ plus symbol**. The menu option can be minimized by tapping on the **- minus symbol**.

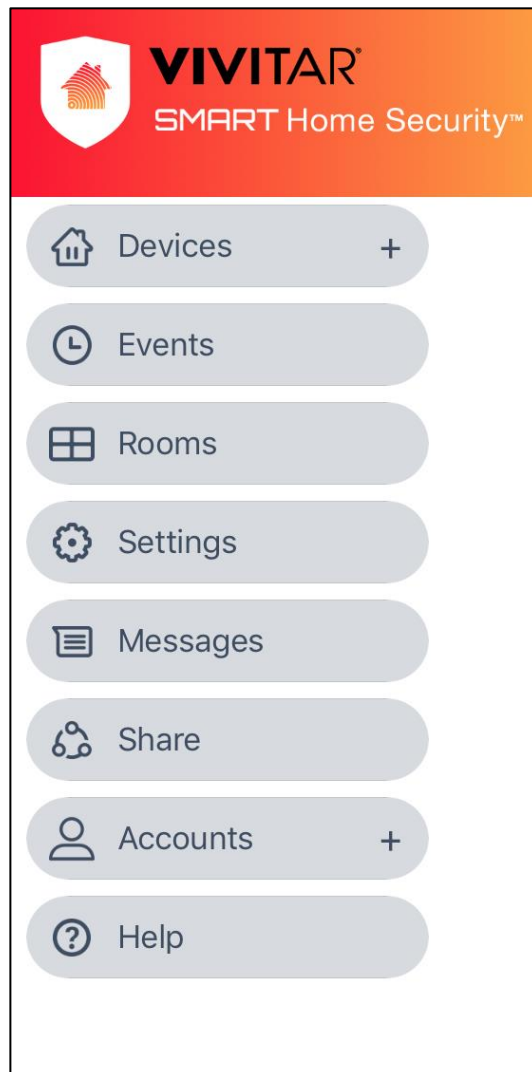

## DEVICES +

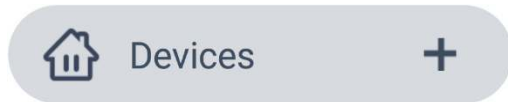

Tap the **Main Menu** button. Then tap **Devices** to go to the 'Devices' Home screen.

From the 'Devices' Home screen, tap  **IP Cameras** to:

- Enter the Live IP Camera view (if you have only one registered IP Camera).
- Enter the 'IP Cameras' screen displaying the list of registered IP Cameras (if you have more than one registered IP Camera). Select one of the video thumbnails to choose a camera to view in Live IP Camera view.

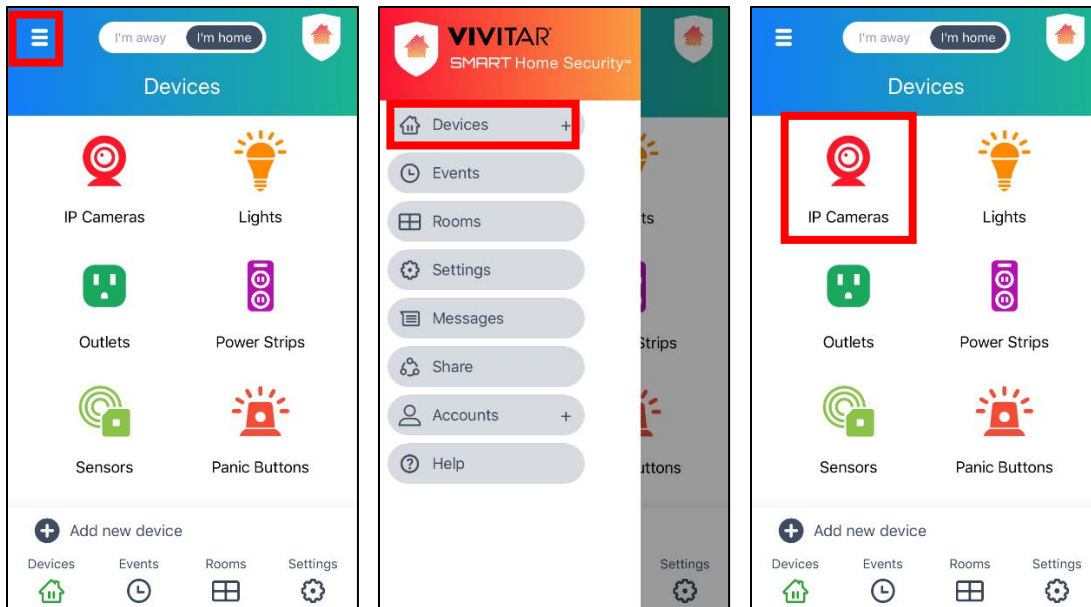

Tap the **Main Menu** button, **Devices**, then tap **IP Cameras**.

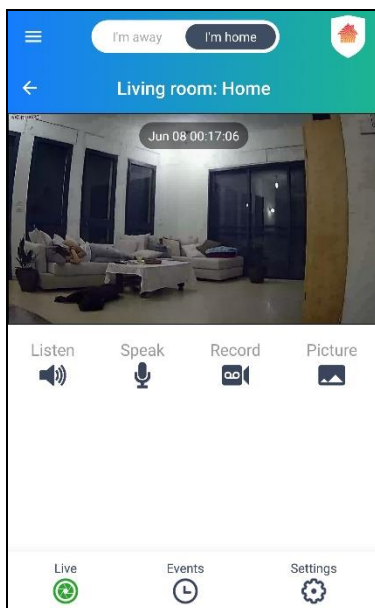

**ONE DEVICE:**  
If one IP Camera is connected > enter the Live IP Camera view.

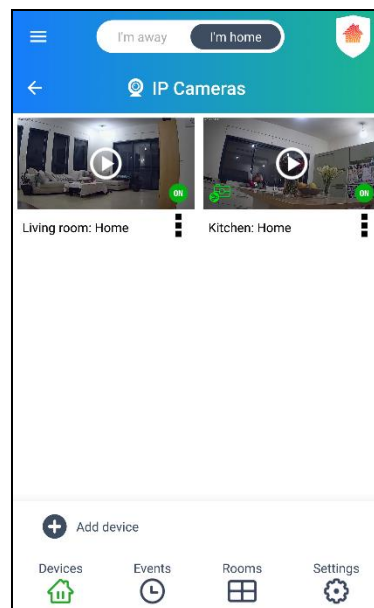

**MULTIPLE DEVICES:**  
If Multiple IP Cameras are connected > enter the 'IP Cameras' Screen and tap a thumbnail image to select your camera. The Live IP Camera view then opens.

Alternatively:

1. Tap the **Main Menu** button.
2. Then tap the **+ (plus symbol)** by the **Devices** option to expand the list of devices within the Main menu.
3. Tap the **IP Cameras** option or the **+ (plus symbol)** by the **IP Cameras** option if you have more than one device connected to expand the list of registered cameras.

NOTE: If there is only one device connected, the plus symbol does not appear.

4. If you have only one device connected, after tapping on **IP Cameras** from the Menu list, the Live IP Camera view appears.

If you have more than one camera connected, after tapping on **IP Cameras** from the Menu List, the IP Cameras screen appears. Tap the camera name/thumbnail you would like to select and see that camera in Live Camera view.

NOTE:

- Tap **Devices > IP Cameras - (the minus symbol)** to close the expanded list of IP Cameras.
- When in other screens, tap the  **Devices** navigation button to open the 'Devices' home screen.

The 'Devices' list includes:

## IP Cameras, Lights, Outlets, Power Strips, Sensors, Panic Buttons

NOTE: List of devices subject to change as per update of new devices.

### 1) IP Cameras

Tap **IP Cameras** to access and control your registered Vivitar Smart Home Security IP Camera(s).

NOTE: Please sign in to or create an account in **GROUP 1** for your IP Camera.

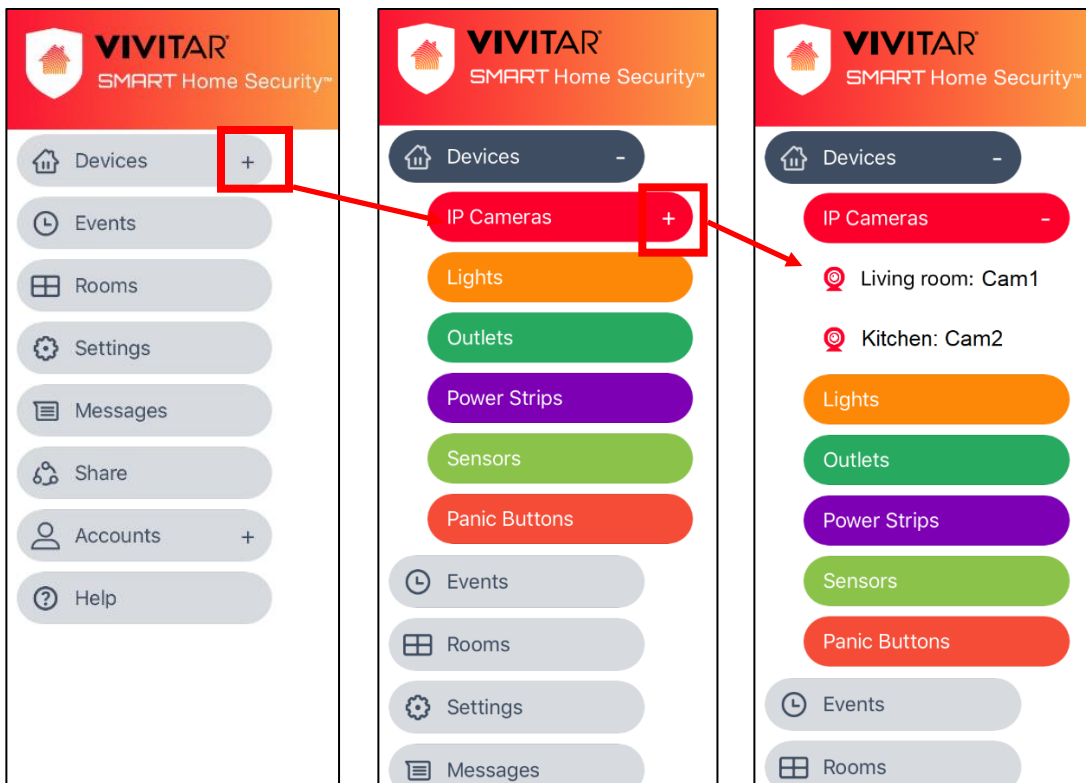

After tapping on **IP Cameras**, the 'IP Cameras' screen or the Live Camera view appears.

- If you have only one registered IP Camera, the IP Live Camera view opens. If you have more than one registered IP Camera, the list of registered IP Cameras appears in the 'IP Cameras' screen. Select one of the video thumbnails to select a camera to view in Live IP Camera view.
- The plus symbol **+** appears by the IP Cameras menu item once you have added a camera. Every new camera is added to the IP Cameras menu as a separate item. You can also tap the **+** (plus) on the IP Cameras menu option to expand the IP Camera list and view your list of registered IP Cameras. Tap on a camera from the list to select it and open the Live Camera view of the selected camera.





2) **Lights**

Tap **Lights** to access and control your registered Vivitar Smart Home Security Light Bulb(s).

NOTE: Please sign in to or create an account in   GROUP 2 or GROUP 4 for your light bulb.

3) **Outlets**

Tap **Outlets** to access and control your registered Vivitar Smart Home Security Outlet(s).

NOTE: Please sign in to or create an account in   GROUP 2 OR GROUP 4 for your outlet.

4) **Power Strips**

Tap **Power Strips** to access and control your registered Vivitar Smart Home Security Power Strip(s).

NOTE: Please sign in to or create an account in  GROUP 2 for your power strip.

5) **Sensors**

Tap **Sensor** to access and control your registered Vivitar Smart Home Security Sensor(s).

NOTE: Please sign in to or create an account in  GROUP 3 for your sensor.

6) **Panic Buttons**

Tap **Panic Buttons** to access and control your registered panic button devices.

NOTE: Please sign in to or create an account in  GROUP 3 for your panic button.

## **EVENTS**



Events are video recordings captured based on the sound/motion detection recorded by your IP Camera. The video recordings are based off on your Home & Away motion detection and sound detection settings.

Your events can be saved to your SD Card and to your Cloud.

NOTE: You must have a Cloud Subscription in order to view your Events.

1. Tap **Events** from the Main Menu to open the 'Events' screen.

NOTE: Alternatively, if you are viewing the Live IP Camera Mode of a selected camera, you can tap on the  **Events** button on the bottom bar to open the 'Events' screen for that specific camera.

2. The list of registered cameras appears. Each camera appears listed as per Room Location Name: Camera Name.
3. Tap on the camera for which you would like to see the list of captured Events.
4. The 'Events' screen opens, displaying the list of recorded events as per SD Card or Cloud.

The  Events button on the bottom navigation bar button is selected, indicating that the Events view is active.

5. There are two options for Events: **SD Card, Cloud**

- Tap **Cloud** to view all the list of all the camera's events. You are required to have a Cloud Subscription to view these events.

- If you have inserted an SD Card, then you can also tap **SD Card** to view the events.

NOTE: The events are automatically saved to the Cloud. If you have inserted an SD Memory Card, then the events are also saved to the SD Card.

6. Scroll down to see all the events listed by order of the date the video was captured.

Each Cloud event thumbnail shows the following regarding the captured event:









Date, Time, Type of Detection – sound or motion.

7. Tap on an event thumbnail in the list to view it in the 'Events Playback' screen.

## Events Playback Screen

The Events Playback screen plays back the selected captured sound or motion event.

The Events Playback Screen displays the following information:

- Camera Location: Name
- Type of detection: Sound detection or Motion detection
- Date and Time. The time progression is shown as the video is played.
- Playback screen: Displays the recording of the video/sound event.
  - Event Type: An icon is displayed on the video indicating whether it is a  Cloud or  SD Card event.
  - Full Screen Playback: Tap the  arrows to display the playback in full screen landscape view. The date and elapsed time appears. Tap the  capture button to take a picture or record a video of the displayed event.
- Video Controls:  Play /  Pause  
Tap the controls to Play or Pause the event.
- Time duration of the captured video – with a slide control to view a specific time within the recorded time.
- Picture: Tap on the  **Picture** button to take a picture from the recorded event as you play the event. The photo is saved to your phone's Photos app.
- Video: Tap on the  **Record** button to save a video of an event or a selection of the event that is currently playing.
  - Tap the **Record** button to start saving the video. The Record button turns green. A  red record indicator blinks with the elapsed recording time next to it, indicating that the recording is in progress.
  - Tap the **Record** button again to stop recording the video. The Record button turns gray. The video is saved to your phone's Photo app.

NOTE: Newly recorded cloud events may take a few minutes to become available for playback.

If the new recording does not immediately playback, please wait a few moments and then playback the event.

## Cloud Events: Cloud Video Recording Subscription Events

A Cloud subscription is required to save and play the Cloud Events.

The Cloud Video Recording Subscription provides the following features:

- Automatically saves and stores the recordings of the last 14 days.  
NOTE: During your 60-day free trial, the recordings of the last 7 days are saved and stored.
- Sends alarm notifications for sound detection and/or motion detection (as per your settings).
- Secures your data in the cloud storage.

NOTE: To subscribe and view your Cloud Events, tap on **Settings > Cloud Subscription**.

Follow the instructions to purchase and activate your Cloud Subscription.

## SD Card Events

NOTE: You must have a Cloud Subscription in order to view your Events.

Motion and sound detection events are automatically saved to the SD card and are both shown as 'Alert' events.

Coming Soon: Scheduled SD card recording time via the selected camera's settings.

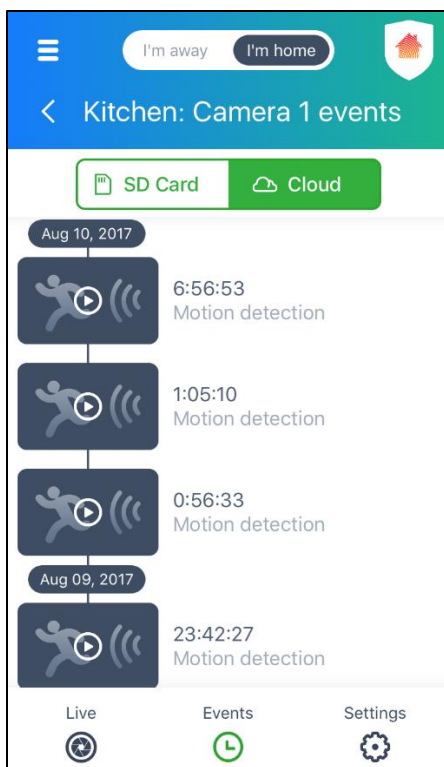

Cloud Events Screen

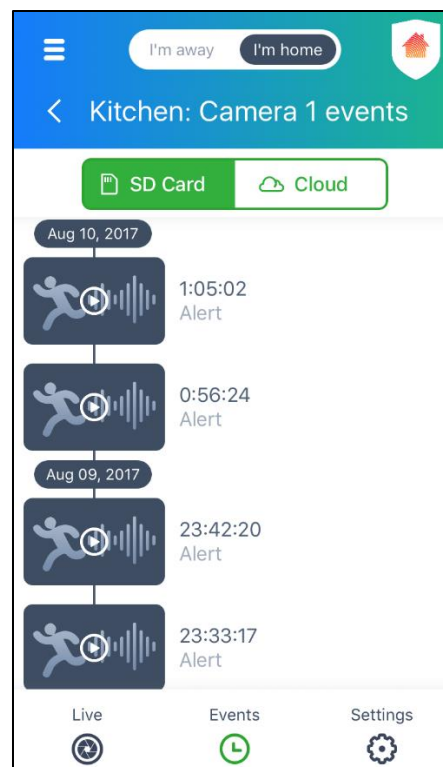

SD Card Events Screen

## ROOMS



Each camera includes the room name as per the room name added during initial setup or via the camera's settings. The room name options include:



Kitchen, Office, Living Room, Dining Room, Bathroom, Bedroom, Hallway, Cellar, and New Room (enter custom room name)

1. Tap **Rooms** from the Main Menu to open the 'Rooms' screen.
2. The list of rooms (room name and icon) per your registered camera(s) appears.
3. Tap on a room to open the list of camera's associated with the selected room.

Each camera appears as a video thumbnail in the selected room screen.

Each thumbnail displays the following:

- **Room Name: Camera Name**

- **Camera Status:**  ON (camera is streaming live video) or  OFF (camera is offline)

-  **Menu Options:** Tap on the device's Menu Options icon to open the window with the following options for the selected camera:

- Remove Device – Tap to remove the selected IP camera from the app.
- Reconnect – ON ANDROID ONLY: Tap to reconnect your IP Camera if Wi-Fi has been disconnected. Make sure your mobile device is connected to Wi-Fi. If the reconnection is not successful, please tap 'Remove device' to remove your device and then tap 'Add Device' and follow the onscreen instructions to add it again.
- Live – Tap to open the 'Live IP Camera' screen.
- Events – Tap to open the 'Events' screen for the selected IP Camera. Note that this option is not available for a camera that is being shared.
- Timeline – Tap to open the 'Timeline' screen for the selected IP Camera.
- Settings – Tap to open the 'Settings' screen for the selected IP Camera.
- Emergency Contacts – Tap to open the 'Emergency Contacts' screen.
- Cloud Subscription – Tap to open the 'Cloud Subscription' screen that displays your current Cloud Subscription status and options.

- Share Device – Tap to open the ‘Share’ screen for the selected IP Camera. Follow the prompts to share your camera with another person. Note that this option is not available for a camera that is being shared.
- Cancel – Tap to close the device’s menu options list.

4. Tap on a video thumbnail to go to the camera’s ‘Live IP Camera’ screen.

NOTE: To change the camera’s room name, tap on **Settings > Room**. Tap to select the room name from the list or tap on **New Room** to enter a custom name for the camera’s room name.

ROOMS:

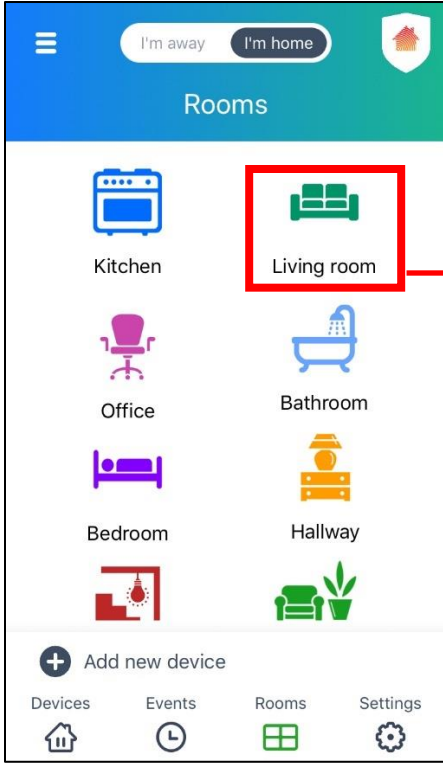

List of room(s) of your registered camera(s)

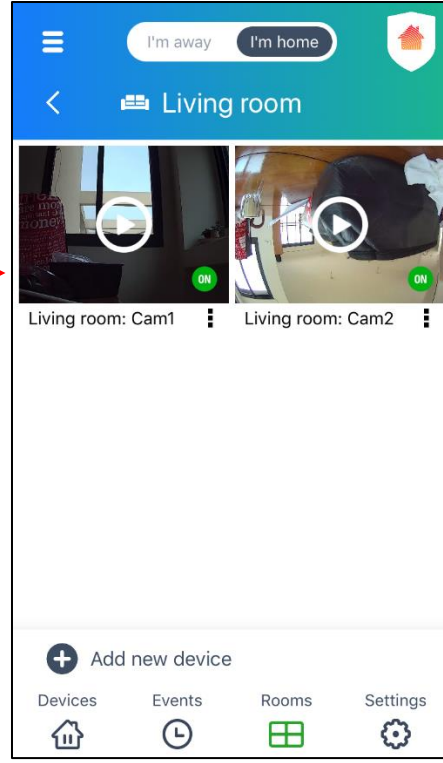

Display of your registered camera(s) for the selected room

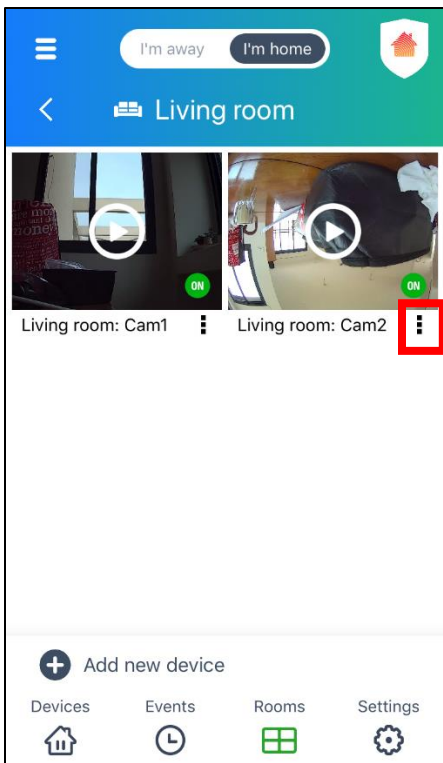

Tap your device's Menu button

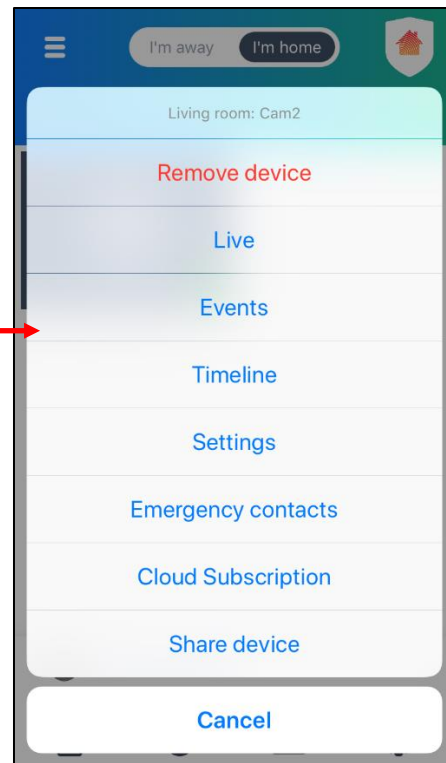

The device options are listed

## **SETTINGS**



Settings

Settings displays the camera information and settings for the selected camera.

1. Tap **Settings** from the Main Menu to open the 'Settings' screen.

NOTE: Alternatively, tap the  Settings button on the bottom navigation bar to open the 'Settings' screen or to go directly to the settings of your selected IP Camera while in Live or Events mode.

2. The list of registered cameras appears on the 'Settings' screen.
3. Tap on your IP Camera to open the 'Settings' screen specific for your selected IP Camera.

The  Settings button on the bottom navigation bar is selected and changes to green.

The following information appears in the camera's Settings screen:

1. Camera **Room: Camera Name**

The room and camera name are displayed on the top of the screen.

2. **UID**

The IP Camera's UID is shown.

3. **Name**

The IP Camera's name is shown. To view and edit the name, tap on 'Name' to open the 'Name' screen. To edit the name, tap on the name field, type in the desired camera name and then tap **Rename** (Android) or **Done** (iOS) to save.

4. **Room**

The IP Camera's room name is shown. Tap to open the screen displaying the room options. The currently selected room appears with a check mark. To change the room, tap on the desired room or enter a custom room name (New Room), then tap the back button to save and return to the previous screen.

## 5. **Owner**

The account name (email) appears. Tap to open the 'IP Cameras & Doorbell' Accounts screen. Please see [Accounts +](#) for more details.

NOTE: This is not available for shared devices.

## 6. **Model**

The Vivitar IP Camera model name appears.

## 7. **Cloud Subscription**

Tap to open the screen displaying your Cloud Subscription status and options.

- If you have not subscribed and would like to subscribe:

Tap **60 days cloud service free trial**.

- If you have already subscribed, you can choose to **change your payment method or unsubscribe**.

**IMPORTANT:** A Cloud subscription is required to save and play the camera's Cloud Events.

The Cloud Video Recording Subscription provides the following features:

- Automatically saves and stores the recordings of the last 14 days.

NOTE: During your 60-day free trial, the recordings of the last 7 days are saved and stored.

- Sends alarm notifications for sound detection and/or motion detection (as per your settings).

- Secures your data in the cloud storage.

See [Cloud Subscription](#) for more information.

NOTE: A shared camera does not allow access to Cloud Subscription.

## 8. **Emergency Contacts**

Tap to open the 'Emergency Contacts' screen. The screen displays your list of contact numbers for the Police, Fire Department, Emergency, and any added custom contacts.

NOTE: Please select **OK/Allow** to allow the app access to your phone's contact when prompted. See Emergency Contacts for more information.

Please tap each item to set the Emergency contact numbers in the fields. These will act as speed dial numbers and will appear in the Alert notifications window you will receive from the Smart Home Security application.

The Emergency contact information includes:

- Police: Tap to enter the phone number for the police.
- Fire Department: Tap to enter the phone number for the fire department.
- Emergency: Tap to enter the phone number of the person you would like to contact in case of emergency or tap to select the emergency contact number from your phone's contact list.
- Add Custom Contact: Tap to select a contact to add.

NOTE: The name and number for each entered contact can be edited or removed by tapping on the contact or the  edit button by the contact.

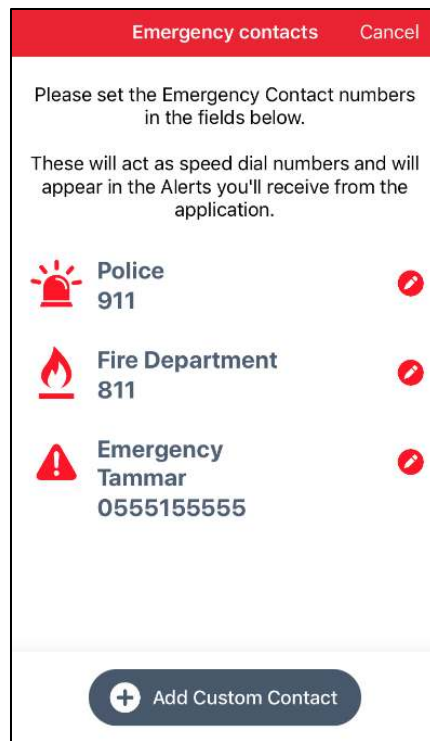

#### ALERT NOTIFICATIONS – CALL EMERGENCY CONTACT:

When you are signed into your account and have your camera connected, your mobile device will detect motion and sound according to the level of detection selected in the camera's Home & Away settings. Once motion/sound is detected, your mobile device will receive an alert notification.

- 1) Tap on the notification to open the Vivitar Smart Home Security app with the Alert notification message displayed.

2) The options in the Alert notification message include:

a) Emergency call:

- Tap on **Emergency call** to open the list of emergency numbers. IMPORTANT: For this list to appear, please make sure to **enter the appropriate phone numbers in the 'Emergency Contacts' screen** from the 'Settings > Emergency Contacts' option.

- Tap on an emergency contact from the list (**Police, Fire Department, Emergency Contact, or added custom contact**) to immediately call that contact or tap **Cancel** to exit the list.

b) Close Window (X): Tap on the **X** to close the alert message window.

**IMPORTANT:** When using the app with Apple iPads or Android tablets, the motion or sound detection alert message window does not include the option to make emergency phone calls from within the app. The 'Emergency call' option to select and immediately call the emergency contact (Police, Fire Department, or Emergency contact) is not available as these mobile devices are unable to make phone calls.

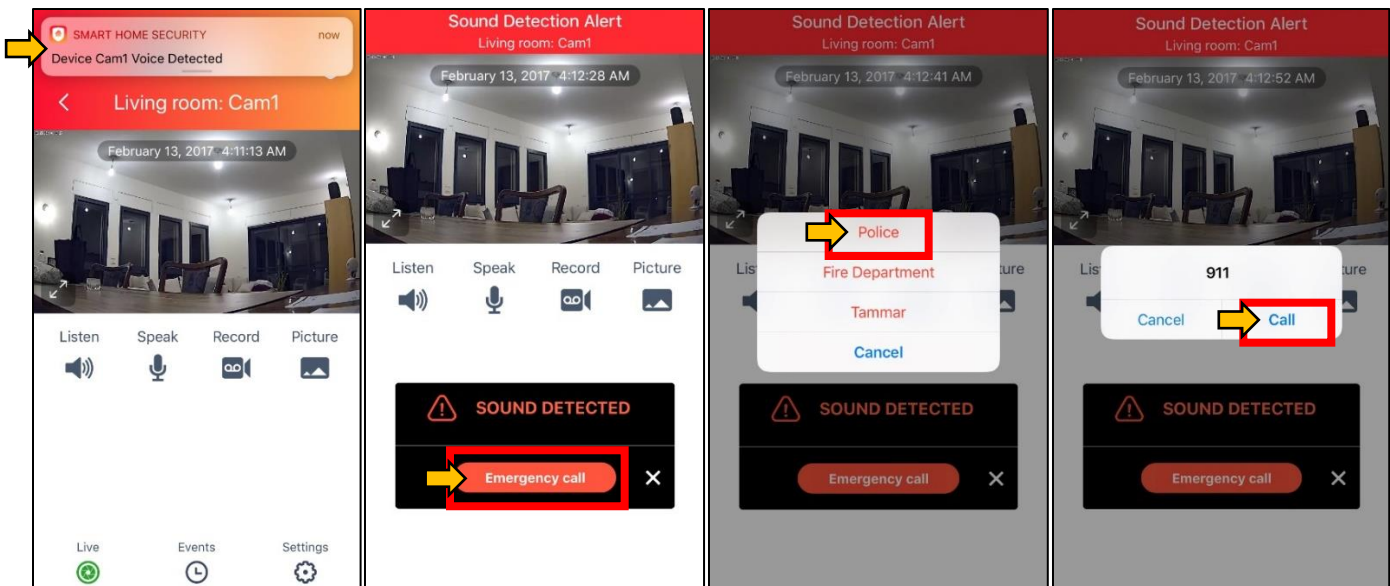

## 9. **Advanced Settings**

Tap to view the following IP Camera settings:

Device Settings, Security Settings, Date/Time Settings, and SD Card Settings

### **DEVICE SETTINGS**

- 1) **Frequency**: Tap **Frequency** from the Advanced Settings list to view this setting. To change the setting, tap on the desired option, then tap the **Back** button to save and return to the previous screen. The Frequency options include:  
50 Hz; 60 Hz
- 2) **Flip & Mirror**: Tap **Flip & Mirror** from the Advanced Settings list to view this setting. To change the setting, tap on the desired option, then tap the **Back** button to save and return to the previous screen. The Flip & Mirror options include:
  - Normal: The live video streaming is shown identical to what is seen.
  - Mirror: The live video streaming is shown reversed, as in a mirror (flipped horizontally).
  - Flip: The live video streaming is shown flipped 180 degrees (appears upside down).
  - Flip & Mirror: The live video streaming is shown flipped 180 degrees (appears upside down) and mirrored.
- 3) **Video Quality**: Tap Video Quality from the Advanced Settings list to view this setting. To change the setting, tap on the desired option, then tap the back button to save and return to the previous screen. The Video Quality options include:  
Low, Medium, High, Max (1080p)

### **SECURITY SETTINGS**

'Security' displays the current setting (On or Off) for:

Motion Detection and Sound Detection.

The security settings cannot be set in this screen, they are displayed for your reference.

The Security options can be viewed and changed in the **Home & Away** settings. Please return to the main Settings screen and then tap on **Home & Away** to set the Security options.

## DATE & TIME SETTINGS

Tap **Sync time with my phone** to sync your camera time with your phone. A message appears in the app once successfully synced.

## SD CARD SETTINGS

1) Schedule SD card recording: Tap to enable/disable and set the scheduled time/day for recording your live video stream.

This feature includes the following options:

- Enabled: Slide the On/Off button to enable or disable.

Enabled: Slide to the right to enable this feature. 

Disabled: Slide to the left to disable this feature:  (Note: All options will be disabled.)

- Start Time: Tap to select the time to begin recording.

After choosing the time, tap **Select** to select the time or **Cancel** to exit the Start Time without selecting the time.

- End Time: Tap to select the time to end recording.

After choosing the time, tap **Select** to select the time or **Cancel** to exit the End Time without selecting the time.

- Repeat: Tap to select on which days the recording should occur. Your selected days appear with a check mark.

- Apply Changes: Tap to save your time and day settings. A message will appear showing that your changes have been applied successfully.

- Back: Tap the **Back** button to return to the Advanced Settings screen.

2) Storage: 'Storage' displays the amount of available and total amount of space on your installed Micro SD Memory card.

3) Format SD Card: Tap 'Format SD Card' to erase and format the installed Micro SD Memory card. A message appears to confirm with the following options:

- Cancel: Tap **Cancel** to return to the settings without formatting the SD card.

- Format: Tap **Format** to format the SD Card. A message appears that the SD card has been formatted successfully. Please use with caution – this feature permanently deletes all the captured SD Card Events.

## 10. **Home & Away**

Tap to open the Home & Away options.

Select your settings for capturing events while you are home and while you are away.

Tap **Home** / **Away** to open the options for each setting.

The Home & Away detection options include:

### - Motion Detection:

**Home**: Off, Low, Medium, High

**Away**: Off, Low, Medium, High

### - Sound Detection:

**Home**: Off, Low, Medium, High

**Away**: Off, Low, Medium, High

NOTE:

- In the Advanced settings screen under 'Security', the settings selected in the Home & Away settings are displayed but cannot be changed. Please select **Home & Away** to change the motion/sound settings for capturing events while you are at home or away from home.

- To apply your Home & Away settings, please toggle the **I'm away** / **I'm home** switch at

the top of your screen. 

## 11. **Firmware**

The IP Camera's firmware version number is displayed.

## 12. **Restart**

Tap **Restart** to restart your IP Camera.

A message appears to reconfirm. Tap **Cancel** to return to the settings without restarting or tap **Restart** to restart your IP Camera.

### 13. Restore Factory Settings

Tap to restore your IP Camera to the factory's original settings.

A message appears to reconfirm. Tap **Cancel** to return to the settings without restoring the factory settings or tap **Reset**.to restore the settings to the default factory settings.

### 14. Remove Device

Tap **Remove device** to remove the IP Camera from your account.

A message appears to reconfirm. Tap **Cancel** to return to the settings without removing the camera or tap **Remove**.to remove the IP Camera from your account. If you have selected to remove the camera, a message appears once the device is successfully removed.

## MESSAGES

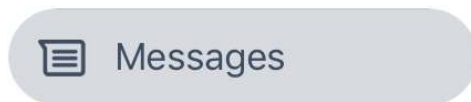

The **Messages** main menu option displays all messages related to sharing your IP Camera and Doorbell devices and messages related to your Cloud Subscription of your IP Camera.

Messages are available only for your Vivitar Smart Home Security IP Cameras and Doorbells.

Messages are not available for your Outlets, Power Strips, Sensors or Lights.

### **MESSAGE NOTIFICATION:**

When a message is received, a red circle with the number of messages received appears on the Main Menu. Tap the Main Menu to expand the menu options. The red circle with the number of messages received is also shown on the Messages. Tap **Messages** to enter the 'Messages' screen. The latest unread message(s) appears with a red circle by the message name. The messages already seen appear with a black circle by the message name.

## VIEW MESSAGES:

Tap **MENU** > **Messages** to open the 'Messages' window.

This displays all messages related to sharing your IP Camera or Doorbell device and messages related to your Cloud Subscription.

The following are message types that can appear:

- Shared Device Message: The message type (Device Share) and date/time are shown at the top of the message. The account name/camera name that is shared with you is displayed, along with the shared status - either Accepted or Declined.
- Cloud Subscription Message: The message type (Cloud Subscription) and date/time are shown at the top of the message. Once you have added your Cloud Subscription, the message appears showing the subscription is confirmed with a brief summary of the subscription.

## DELETE MESSAGES:

If you would like to delete all the messages, tap **Clear All**.

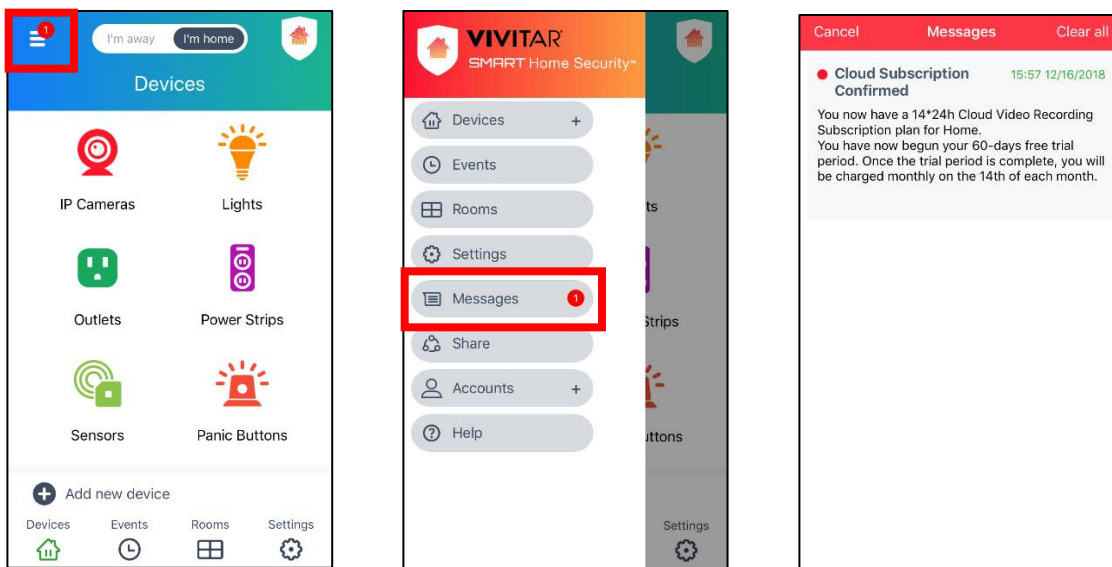

## **SHARE**



The **Share** main menu option allows you to share your device(s) with other users that have installed the Vivitar Smart Home Security app.

1. Tap **Share** from the Main Menu.
2. The 'Share Devices' screen appears displaying the list of devices registered to your account that are available to share.
3. Tap on your IP Camera.
4. The 'Share' window appears with the following information needed:

### RECIPIENT ACCOUNT:

Enter your recipient's account (email) or scan in the recipient's QR Code (as seen in their device's Accounts information).

5. SHARE:

Once you have entered the recipient's account name, tap **Share**.

RECIPIENT SHARE NOTIFICATION: The recipient receives a 'Device Sharing' notification.

They need to tap the notification to open the message or access the message from the MENU > 'Messages' screen. In this 'Device sharing' message, the recipient has the following options:

- Decline: The recipient can tap **Decline** to reject the sharing of your camera.
- Accept: The recipient can tap **Accept** to accept and begin sharing your device.

6. 'SHARE TO' LIST:

After tapping **Share**, the 'Share' screen in your app now displays the list of 'Shared to' devices which shows the recipient's account name.

DELETE: If you would like to remove the shared account, tap on the  **Delete** button by the Shared account name, then tap **Remove** to delete the account.

7. MESSAGES:

- A message is received once the recipient has agreed or declined the share request.
- The recipient also receives a message displaying the Device sharing status to be either Accepted or Declined – as per the recipient's selection.

Once your IP Camera is shared with the recipient, the recipient now is able to select your camera from the 'Devices > IP Cameras' screen. They can view the live streaming video from your camera, record video and take pictures.

NOTE:

- The recipient cannot change any of your camera settings.
- The recipient cannot view your captured Cloud Events nor SD Card Events.
-  The recipient's shared device appears with a shared device icon.
- See [Sharing IP Cameras](#) for more information.

## ACCOUNTS +

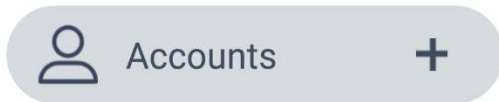

You must have an account to use your IP Camera or additional Vivitar Smart Home Security devices. After creating your account, your IP Camera is connected to this specific user account and you must be signed into this account when using the app with this camera. Your user account also allows you access to the Cloud Subscription from Settings.

NOTE: If you use your IP Camera account on another mobile device, the mobile device where the IP Camera was initially added has main access to the app. This means that if you open and use the app on a different mobile device, and then open the app on the initial mobile device, the app on the different device will notify the user that the IP Camera account has been signed in using another mobile device and will sign you out of the account. You will need to sign in to the IP Camera account again on the other mobile device in order to use the camera on both mobile devices.

The **Accounts** main menu option lists the Vivitar Smart Home Security Accounts as per device Group. Each device must be registered according to the device Group. The 'Accounts' option allows you create an account, sign in to your account or sign out of your account.

After creating or signing in to your account as per the app Group, your device is connected to this specific user account and group. You must be signed into this account when using the app with this device. Each account includes a QR Code that can be used to scan in when sharing devices.

**IMPORTANT: You must have an account to use your device.**

The app Account Groups include:



- **1 Group 1:** This is for **IP Cameras**.

**NOTE: The IPC113v2 Smart Security Wi-Fi Cam is a Group 1 Device.**

- **2 Group 2:** This is for the designated **Lights and Outlets** as listed in the app.
- **3 Group 3:** This is for **Sensors**.
- **4 Group 4:** This is for the designated **Lights and Outlets** as listed in the app.



There are two ways to access your Accounts via the Main Menu – Compact Menu / Expanded Menu.

### Accounts: Compact Menu

1. Tap the  **Main Menu** button to view the menu options.
2. Then tap the  **Accounts** menu option to open the 'Accounts' screen.
3. The 'Account's screen lists the account(s) per Account group.
4. From the 'Accounts' screen, tap on an account to open the information for that account.
5. The following information appears for each account:
  - **Account Group Name**
  - **Account Name**  
Your account name (your email) is displayed.
  - **Account QR Code**  
The QR Code contains your account name information so that another user can scan this code from their mobile device in order to share devices.
  - **Sign Out**  
Tap the **Sign out** button to sign out of your Group Account.  
A message to reconfirm appears. Tap **Cancel** to remain signed in or tap **Sign out** to sign out.

### Devices: Expanded Menu

The expanded menu view allows you to easily see the list of device Group Accounts and to quickly enter the selected Group's Account.

1. Tap the  **Main Menu** button to view the menu options
2. Then tap the  **+ plus symbol** on the right side of 'Accounts' menu button to expand and show the Groups list of Accounts within the Main menu.

NOTE: After expanding the Accounts menu option, to close the expanded view, tap the  **(minus symbol)** on the right part of the Accounts menu button.

3. The following is shown under the Accounts menu option:

**Group 1, Group 2, Group 3, Group 4**

- Tap a specific group to select it.

The following two options are available:

a) Sign in/ Create Account

If you have selected a Group to which you do not yet have an account or have not signed in, then the 'Sign In' screen appears prompting you to either sign in or create and account.

b) Account Details

If you have already created and account and are signed in, then your account information is shown:

- **Account Group Name**
- **Account Name**

Your account name (your email) is displayed.

- **Account QR Code**

The QR Code contains your account name information so that another user can scan this code from their mobile device in order to share devices.

- **Sign Out**

Tap the **Sign out** button to sign out of your Group Account.

A message to reconfirm appears. Tap **Cancel** to remain signed in or tap **Sign out** to sign out.

## **HELP**

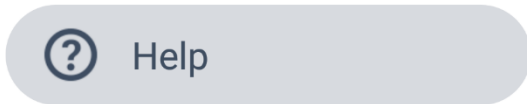

The Help opens the Help menu.

Tap **Help** from the Main Menu to open the 'Help' window. The following list of options appears:

1. About:

Tap **About** to open the window displaying the Smart Home Security copyright and version number.

Tap **Cancel** to exit the 'About' window.

2. Help:

Tap **Help** to open the online Help.

3. User Manual:

Tap **User Manual** to open the online User Manual.

4. License:

Tap **License** to view the License Agreement.

5. Cancel:

Tap **Cancel** to exit the 'Help' window.

## NAVIGATION BAR

---

The bottom navigation bar allows you to quickly and easily access the controls for your Smart Home Security. When selected, the navigation button appears in green.



### **Devices:**

Tap **Devices** to open the Devices screen. The Devices screen displays the list of Vivitar Smart Home Security devices: IP Cameras, Lights, Outlets, Power Strips, Sensors, Panic Buttons. See [Devices](#) for more information.

### **Events:**

Tap **Events** to open the Events screen. If you have more than one registered camera, the list of cameras appears. Tap on one of the cameras from the list to open the 'Events' screen for the selected camera. If you have only one registered camera, that camera's 'Events' screen automatically opens.

The 'Events' screen displays the video recordings captured as per the sound/motion detection recorded by your IP Camera. The video recordings are based on your Home & Away motion detection and sound detection settings. Your Events can be saved to your SD Card and to your Cloud. See [Events](#) for more details.

### **Rooms**

Tap **Rooms** to open the Rooms screen. The Rooms screen displays the room that your camera is connected to. If you have multiple cameras registered and connected or shared to the app, then the room name and icon for each camera is shown.

NOTE: Each camera includes a room name as per the room name added during initial setup or via the camera's settings. The room name options include: Kitchen, Office, Living Room, Dining Room, Bathroom, Bedroom, Hallway, Cellar and New Room (custom added room name)

See [Rooms](#) for more information.

### **Settings**



Tap **Settings** to open the settings screen for your connected camera. See [Settings](#) for more information.

## IP CAMERAS SCREEN

---

The 'IP Cameras' Screen appears if your camera is offline, or if you have more than one camera connected. Each of your Smart Home Security IP Cameras appear on the 'IP Cameras' Screen.

To access your IP Cameras screen:

 Tap the **Devices** button on the bottom navigation bar, then tap  **IP Cameras**.

Alternatively, tap  **Menu** >  **Devices** >  **IP Cameras**.

NOTE: If you have only one connected IP Camera, then the Live IP Camera screen opens and not the IP Cameras screen.

The 'IP Cameras' screen displays a Thumbnail image for each connected camera.

Each camera Thumbnail displays the following:

- **Camera Room : Camera Name**

Your registered camera room and camera name appear below the thumbnail.

- **Camera Status - On / Off**

If your camera is online, the  ON indicator appears on the thumbnail.

If your camera is offline, the OFF indicator appears on the  thumbnail.

- **Shared**

If you have added a shared camera, the  shared icon indicator appears on the thumbnail of the shared camera.

- **Camera Menu**





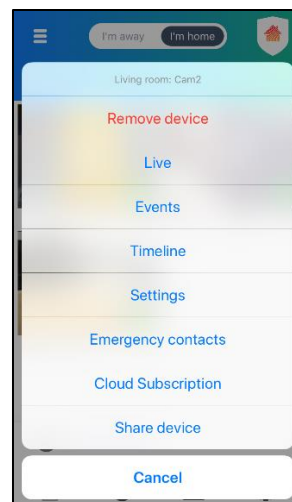
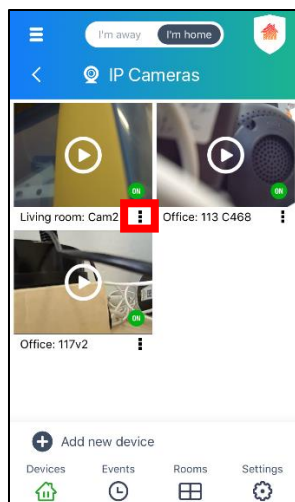

The  Camera Menu button appears below the thumbnail image by the camera name.

The menu options include:

- REMOVE DEVICE: Tap to remove the selected IP camera from the app. You will be asked to reconfirm. Tap **Remove** to remove the device or **Cancel** to exit without removing the camera.
- RECONNECT: ON ANDROID ONLY: Tap to reconnect your IP Camera if Wi-Fi has been disconnected. Make sure your mobile device is connected to Wi-Fi. If the reconnection is not successful, please tap 'Remove device' to remove your device and then tap 'Add Device' and follow the onscreen instructions to add it again.
- LIVE: Tap to open the 'Live IP Camera' screen.
- EVENTS: Tap to open the 'Events' screen for the selected IP Camera. Note that this option is not available for a camera that is being shared.
- TIMELINE: Tap to open the 'Timeline' screen for the selected IP Camera.
- SETTINGS: Tap to open the 'Settings' screen for the selected IP Camera.
- EMERGENCY CONTACTS: Tap to open the 'Emergency Contacts' screen.
- CLOUD SUBSCRIPTION: Tap to open the 'Cloud Subscription' screen that displays your current Cloud Subscription status and options.
- SHARE DEVICE: Tap to open the 'Share' screen for the selected IP Camera. Follow the prompts to share your camera with another person. Note that this option is not available for a camera that is being shared.
- CANCEL: Tap to close the device's menu options list.



The 'IP Cameras' screen include the following navigation options:

- **Back:** Tap the **Back** button to return to the Devices. Screen.
-  **Add Device:** Tap **Add Device** to open the 'Add new device' screen and add a new IP Camera from the list that appears.
- **Navigation Bar:** Tap one of the following options on the Navigation bar to enter the selected screen:  **Devices**,  **Events**,  **Rooms**,  **Settings**.
-  **Main Menu:** Tap the **Main Menu** button to open the main menu options.

Tap an IP Camera's Thumbnail to enter the Live IP Camera view for the selected camera.

NOTE: Please make sure the camera is connected. The **ON** symbol appears on the Thumbnail when it is connected.

# DEVICES

---

The 'Devices' home screen displays the list of device types that you can control and use via the Vivitar Smart Home Security app.

These devices include: **IP Cameras, Lights, Outlets, Power Strips, Sensors, Panic Buttons**

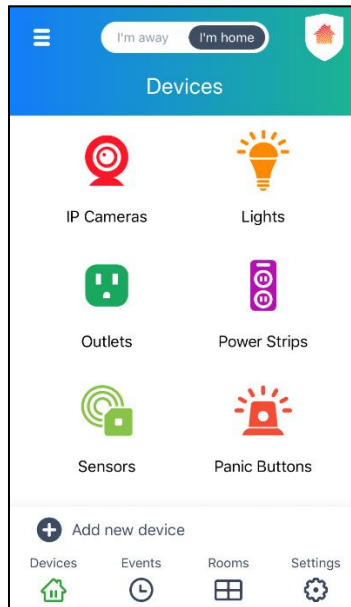

NOTE: List of devices subject to change as per update of additional devices.



## 1. IP Cameras

Tap **IP Cameras** to go to the 'IP Cameras' screen or directly to the Live View screen.

NOTE: Please sign in to or create an account in  GROUP 1 for your IP Camera.

## 2. Lights



Tap **Lights** to go to the 'Lights' screen or directly to the Lights Dashboard screen.

NOTE: Please sign in to or create an account in   GROUP 2 or GROUP 4 for your light bulb.



### 3. Outlets

Tap **Outlets** to go to the 'Outlets' screen or directly to the Outlets Dashboard screen.

NOTE: Please sign in to or create an account in   GROUP 2 OR GROUP 4 for your outlet.



### 4. Power Strips

Tap **Power Strips** to go to the 'Power Strips' screen or directly to the Power Strips Dashboard screen.

NOTE: Please sign in to or create an account in  GROUP 2 for your power strip.



### 5. Sensors

Tap **Sensors** to go to the 'Sensors' screen or directly to the Sensors Dashboard screen.

NOTE: Please sign in to or create an account in  GROUP 3 for your sensor.



### 6. Panic Buttons

Tap **Panic Buttons** to go to the 'Panic Buttons' screen or directly to the Panic Button Dashboard screen.

NOTE: Please sign in to or create an account in  GROUP 3 for your Panic Button.

## **IP CAMERAS**

Each connected IP Camera includes the following features:

- **Live View:**

 Tap to view the selected camera in Live IP Camera view. This option is available once you have connected your camera and have entered the Live IP Camera view.

See [Live IP Camera view](#) for more information.

- **Events View:**

 Tap to view the selected camera's list of SD and Cloud Events.

See [Events](#) for more information.

- **Rooms View:**

Tap to view the screen with connected device list shown by the room name.

See [Rooms](#) for more information.

- **Settings View:**

 Tap **Settings** to view the 'Settings' screen for the selected device.

See [Settings](#) for more information.

- **Home and Away Modes:**

Switch the Home & Away modes when you leave your home and when you come back to automatically adjusts all your devices security settings in your home.

See [Home & Away Modes](#) for more information.

- **Share Device:**

Share your IP Camera with another user.

See [Sharing IP Cameras](#) for more information.

# SHARING IP CAMERAS

---



You can share your IP Camera with another user. Your shared device can be used for viewing your IP camera's live stream.

## SHARE YOUR DEVICE

### 1. ACCESS THE SHARE SCREEN:

To share your IP Camera with someone, please follow the steps below:

tap the following: **Menu > Share**

Note: Alternatively, you can access the 'Share' screen for a specific IP Camera via the selected camera's  Camera Menu 'Share' option. The  Camera Menu is found below each device Thumbnail image in the 'Rooms' and 'IP Cameras' screens.

### 2. SHARE DEVICES SCREEN – SELECT IP CAMERA:

The 'Share devices' screen appears if you have more than one connected IP camera.

Tap on a **device name** to select it and to set up the sharing with another user.

NOTE:

 Connected IP Cameras appear in the camera list with a red IP Camera icon.

 Those IP cameras that are not connected appear with a black IP Camera icon.

### 3. ENTER RECIPIENT'S ACCOUNT (EMAIL):

After the IP Camera is selected, the 'Share' window opens.

Enter the recipient's account name (registered email) and tap **Share**.

Alternatively, you can scan in the recipient's Account QR Code which stores the account name:

- Go to the other user's app, tap **Menu > Accounts > Group 1 (IP Cameras)**. The recipient's Account QR Code appears on the screen.

- Then in your mobile device's Vivitar Smart Home Security app, tap on the  **Bar Code** icon in the 'Share' screen.

- Scan the recipient's Account's QR Code. This automatically identifies the user's name (email).

### 4. SHARE:

After entering the recipients account name, tap **Share**.

## 5. SHARE MESSAGE - RECIPIENT:

The recipient will get a Device sharing message in **Menu > Messages**.

- The recipient will need to view this message in order to ACCEPT or DECLINE the device sharing. The recipient must tap **Accept** in the message to see your shared IP Camera in the Devices screen and in the Live IP Camera view.

- After accepting the device sharing, a new message is displayed in the recipient's messages that shows you have shared a device with him/her and that the status is 'Accepted'.

## 6. UPDATE TO YOUR SHARED LIST:

In your 'Share' screen, the recipient's name (email) appears in the 'SHARED TO' list.

You also receive a message that your device is being shared

## 7. SHARED IP CAMERA'S APPEARANCE IN THE SMART HOME SECURITY APP:

The shared device will appear in the recipient's Vivitar Smart Home Security app.

- In the 'IP Cameras' screen the shared camera's video thumbnail is shown with the

SHARED icon indicator .

- In the recipient's 'Live IP Camera' screen, the shared IP Camera is displayed with the

SHARED icon  and your account (email) below the Live Camera control buttons.

## REMOVE SHARED DEVICES

To stop sharing your device with another user:

### 1. Tap **Menu > Share**.

Alternatively, from the selected camera's  Camera Menu via the 'IP Cameras' or 'Rooms' screen, select **Share** to open the 'Share' screen.

### 2. The 'Share devices' screen opens if you have more than one connected IP camera.

Tap on the device name that is being shared to select it.

### 3. The 'Share' screen opens.

Select the device name from the SHARED TO list and tap the **X** (Android) or  (iOS) remove button.

### 4. The other user will get a Device sharing message informing him that the shared device was removed. This message can be found in **Menu > Messages**.

## TO SHARE YOUR DEVICE:

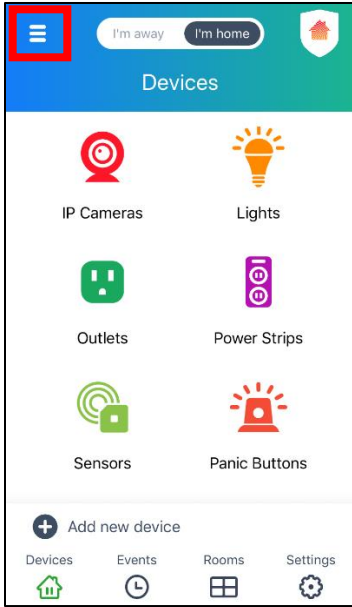

1. Tap **Menu**.

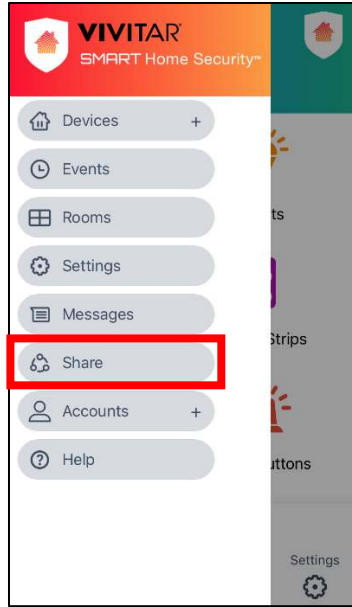

2. Tap **Share**.

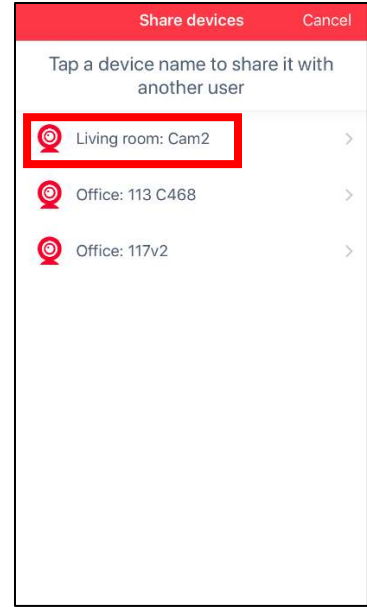

3. Tap a **device** to select it.

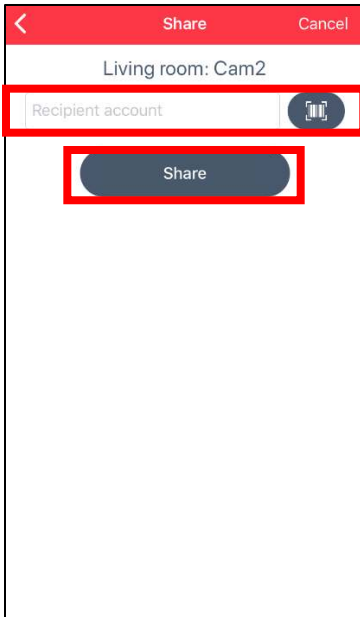

4. Enter the recipient's account (email). Alternatively, tap on the Bar Code icon to scan in the recipient's Account Bar Code as seen in his/hers **Menu > Accounts** screen. Then tap **Share**.

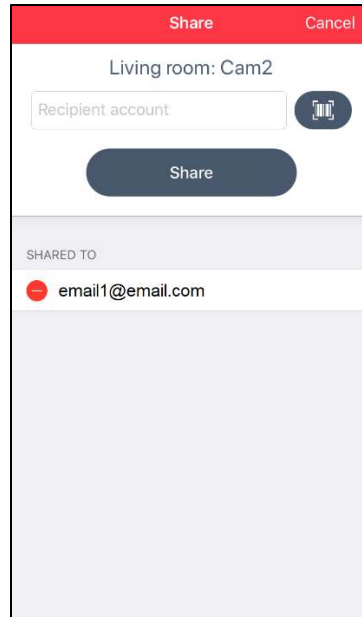

5. The SHARED TO list appears with the recipient's account (email).  
NOTE: To stop sharing your camera with the recipient, tap the **X** (Android) or **⊖** (iOS) button then tap **Remove**.

## THE RECIPIENT'S DISPLAY OF YOUR SHARED DEVICE:

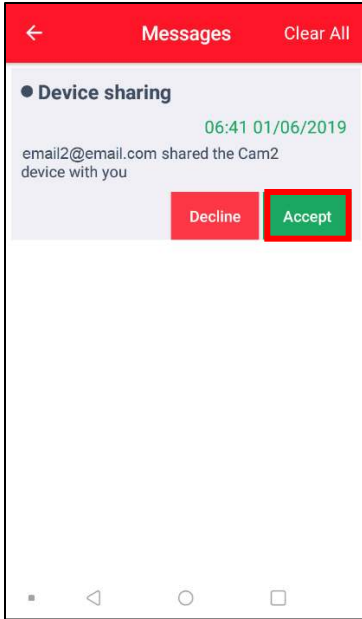

6. The recipient receives a message. The recipient must tap **Accept** to be able to view your camera in Live IP view.

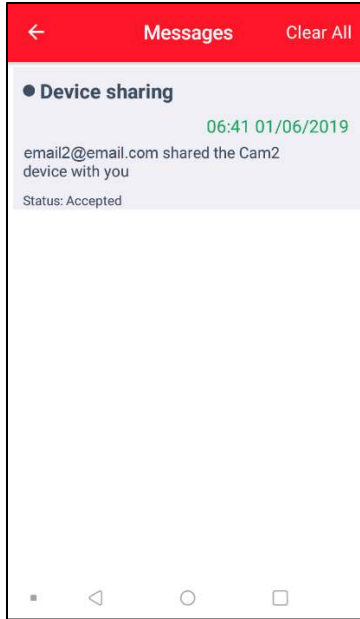

7. Once the recipient accepts the device sharing, he/she receives an updated message showing that the device sharing status is 'Accepted'.  
NOTE: You also receive a message that your device is being shared.

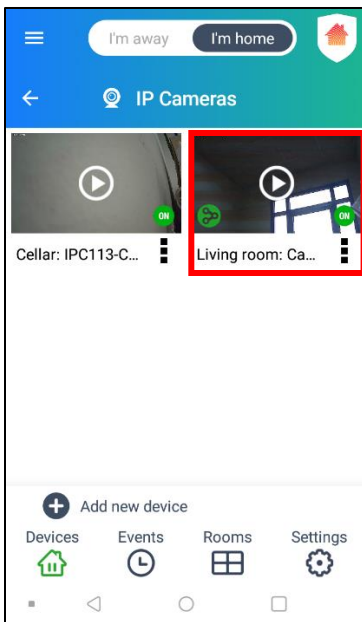

8. The recipient's 'IP Cameras' screen shows your shared IP camera in the thumbnail list of devices. The camera thumbnail displays the current camera status (OFF or ON) and the Shared Device icon:

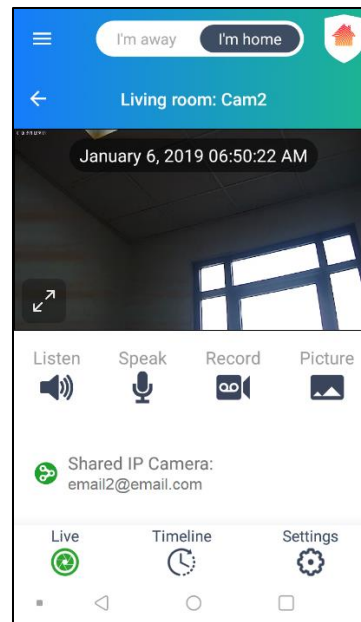

9. The recipient's 'Live IP Camera' screen shows your shared IP camera account name listed below the live camera controls, along with the Shared Device icon.

## RECONNECTING DEVICES

---

### **RECONNECTING: WHEN USING THE SAME WI-FI**

To reconnect your IP Camera to the Vivitar Smart Home Security app, please check that you are using the same Wi-Fi configuration as was used to set up your IP Camera.

1. Make sure your IP Camera is plugged in and powered on.
2. Launch the Vivitar Smart Home Security app.
3. Tap **IP Cameras** from the 'Devices' home screen.
4. To select your IP Camera, tap your IP Camera's video thumbnail as shown in the 'IP Cameras' screen.
5. The connection should automatically refresh, and the Live IP Camera view screen opens.

### **RECONNECTING: WHEN CHANGING TO A DIFFERENT WI-FI**

To reconnect your IP Camera to the Vivitar Smart Home Security app when you change to a different Wi-Fi, please [LONG RESET](#) the camera using the reset tool so that the Wi-Fi configuration to connect the devices can be reset.

This means that when you place your already added IP Camera in a location with a different Wi-Fi than the one used when the device was added, please follow the steps below to long reset your IP Camera:

#### **LONG RESET**

1. Plug in your IP Camera and make sure it is powered on.  
Please remember that this Long Reset is needed only when resetting the camera's Wi-Fi to a new Wi-Fi. It is used when the current location has a Wi-Fi that is different than the one used to add the camera initially.
2. About 5 seconds after your IP Camera has been plugged in, the camera emits 'Please wait for Wi-Fi Connecting' and the blue LED light blinks.
3. Use the Setup Tool (supplied) or a small pin to press the RESET button (hole) on the back of the camera. Press and hold the reset button for approximately 30 seconds.





- After about 5 seconds the camera emits 'Reset Success'.
  - **Very important:** Please make sure to *continue holding and pressing the button* to progress with the Long Reset that allows you to reset the Wi-Fi.
  - After about **30 seconds**, the camera emits 'Please use mobile phone for Wi-Fi configuration. Reset success.'
  - Please release the Reset tool.
4. The LED light begins blinking red which indicates the reset is complete and the camera is in standby mode, ready to be connected. The camera emits again 'Please use mobile phone for wi-fi configuration.'
  5. Please launch the app and select your previously added camera from the IP Cameras screen.
  6. If the app shows that your IP Camera is still offline, please remove your IP Camera and add it again.

#### REMOVE CAMERA:

There are a few ways to remove your camera:

- a) Via Settings: Open your IP Camera's 'Settings' Screen. Tap the **Remove device** option listed at the bottom of the options. Tap **Remove** in the window that appears to confirm. Your camera will be removed from the app.
- b) Via Camera Menu: Tap on your selected IP Camera's  Camera Menu (as seen in the 'Rooms' or 'IP Cameras' screen), then tap **Remove device** from the list of menu options. Tap **Remove** in the window that appears to confirm. Your camera will be removed from the app.

#### ADD CAMERA:

- a) From the 'Devices' screen or the 'IP Cameras' screen, tap  **Add new device**.
  - From the 'Devices' screen > Tap  **Add new device** > Tap  **IP Cameras** > Tap the **IP Camera from the list** that you would like to add.
  - From the 'IP Cameras' screen (displays if you have more than one camera added or an offline camera) > Tap  **Add new device** > Tap the **IP Camera from the list** that you

would like to add.

- b) The camera's red LED light should be blinking rapidly. Please make sure your camera is plugged and has been reset. Reset/Long reset if needed.
- c) Tap **Continue** to open the 'Configure Network' screen.
- d) Enter your Wi-Fi's password then tap **Continue**.
- e) After your IP Camera has been successfully added, set your camera's name and location and then tap **Done**.
- f) Tap either **Next** or **Cloud Subscription**.

CLOUD SUBSCRIPTION: Tap **Cloud Subscription**. The Cloud Subscription screen then appears. If you have not already subscribed, please follow the onscreen instructions to subscribe to your camera's Cloud Storage.

NEXT: Tap **Next** on the message window to proceed to the Devices screen/Live IP Camera Mode screen without subscribing to the Cloud Storage.

NOTE: If you choose to skip the Cloud Subscription, you can access the Cloud Subscription at any time from the selected camera's settings. A Cloud Subscription is required to playback your recorded cloud events.

If the app shows that your IP Camera is still offline, please remove your IP Camera and add it again. Please see the [Troubleshooting](#) section below with details on how to remove the camera and add it again with the new Wi-Fi.

## **RECONNECTING: TROUBLESHOOTING**

**Q: I cannot reconnect to my IP Camera after trying to reconnect as outlined above or after a factory reset.**

**A:** If you tap on your camera's video thumbnail from the IP Camera screen to reconnect as described above or if you do a factory reset via the application and there is no connection with your previously added camera, a window will appear in the app that shows your 'Device is offline'. The following options appear in the window: **OK/Cancel** and **Remove**. If you have checked that your camera is plugged in and powered on, then please proceed with the steps below to remove your camera and add it again.

### **REMOVE CAMERA FROM APP**

1. Tap **Remove** from the window option that appears after tapping on the video thumbnail.

NOTE: You can also remove your IP Camera via the menu that appears below your IP Camera in the 'IP Cameras' screen. Select 'Remove Device' from this menu or tap the 'Settings' option from the menu and then select 'Remove Device'.

2. If the camera light is not blinking red, then please proceed to reset your IP Camera. Please see [Long Reset](#) for more information on how to reset your IP Camera and the Wi-Fi connection.
3. Then from the 'IP Cameras' or 'Devices' screen, tap  **Add new device** to add your device again.

Please see [ADD NEW DEVICE](#) for instructions on how to add your device again.

**Q: I cannot reconnect to my IP Camera after completing a factory reset via the application.**

**A:** Your IP Camera needs to be reset, and you will need to add your device.

1. Please see [Camera Reset](#) for more information on how to reset your IP Camera.
2. Please see [ADD NEW DEVICE](#) for instructions on how to add a new device.

**Q:** I cannot reconnect to my IP Camera after changing to a different Wi-Fi network and resetting the camera. While adding the camera again, the IP Camera emits 'Password error. Please configure again'.

**A:** Please make sure you have entered the correct Wi-Fi password in the 'Configure Network' screen. Go back to this screen or add the device again to enter the correct Wi-Fi password. The connection will not succeed if the password is incorrect, so please make sure it is the right one. Tap **Show password** to assist you with viewing the password as you enter it.

## HOME AND AWAY MODES

---

Set your IP Camera security settings to detect motion and sound while you are home or away from home.

When motion or sound is detected, a video is automatically recorded.

These recorded videos can be seen in the 'Events' screen according to date and time taken. A notification is sent to your phone when motion or sound is detected.

To set your IP Camera security settings for the Home and Away modes please follow the instructions below:

1. Tap **Devices** > **IP Cameras** > **Live IP Camera** (tap Video Thumbnail) > **Settings**.

Alternatively: Tap  **Settings** from the bottom navigation bar or from the Main Menu list, and then select your connected IP Camera.

2. Tap **Home & Away** to open the Home & Away settings.

This includes the settings for **Motion Detection** and **Sound Detection**.

### A) MOTION DETECTION

- **Motion detection - HOME:**

Select one of the options to set up the Motion detection level in the Home mode:

Tap > **OFF**, **Low**, **Medium** or **High**.

NOTE: The app default is set to OFF while you are at home.

- **Motion detection - AWAY:**

Select one of the options to set up the Motion detection level in the Away mode:

Tap > **OFF**, **Low**, **Medium** or **High**

NOTE: The app default is set to Medium while you are away from home.

## B) SOUND DETECTION

- **Sound detection - HOME:**

Select one of the options to set up the Sound detection level in the Home mode:

Tap > **OFF**, **Low**, **Medium** or **High**.

NOTE: The app default is set to OFF while you are at home.

- **Sound detection - AWAY:**

Select one of the options to set up the Sound detection level in the Away mode:

Tap > **OFF**, **Low**, **Medium** or **High**

NOTE: The app default is set to Medium while you are away from home.

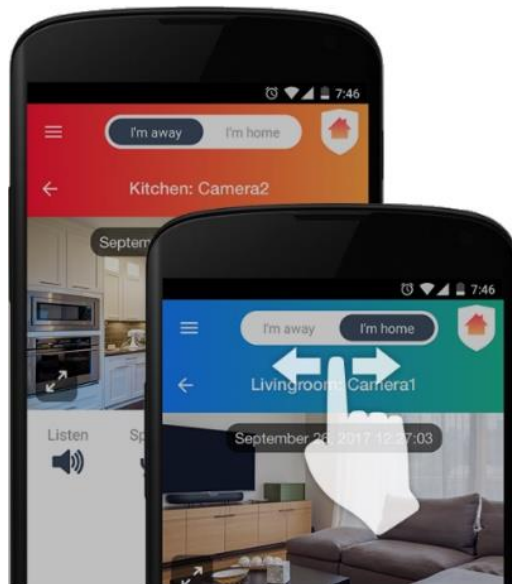

### **HOME & AWAY MODES**

Switch the Home & Away modes when you leave your home and when you come back to automatically adjust all the devices' security settings in your home.

Slide your finger on the Home/Away mode button to select the mode 'I'm away' or 'I'm home'.

NOTE: The top background color for Away Mode is red and for Home Mode the background color is blue.

## FULL SCREEN LIVE STREAMING VIDEO MODE

---

1. From the IP Live Camera Mode screen tap, the  **Full Screen** button to view the Live IP Camera video stream in full screen (landscape view).

2. The following appears on the Full Screen Mode screen:

- The date and time appear on top.

-  Tap the options expand button to open and view the options below. Tap again to close the options.

### **Listen:**

Tap to enable or disable listening to the incoming sound from your IP Camera. The 'Listen' button turns green when enabled and the sound from the streaming video can be heard.

### **Speak:**

Tap to enable or to disable speaking via the Vivitar Smart Home Security app on your mobile device and having that sound emit through your IP Camera. The 'Speak' button turns green when enabled.

### **Record:**

Tap to start recording a video from the live stream. Tap again to stop recording. The video is saved to your mobile device's Photos app. The 'Record' button turns green when enabled.

### **Picture:**

Tap to take a picture from the live stream. The picture is saved to your mobile device's Photos app. The 'Picture' button turns green when in use.

Tap the Live camera video stream to return to Live IP Camera screen.

-  Tap the **Exit** full screen button to return to the Live IP Camera screen.

Live IP Camera View: Portrait View

Tap on the ↗ **Full Screen** button to open the Live IP Camera View in Full Screen, Landscape View.

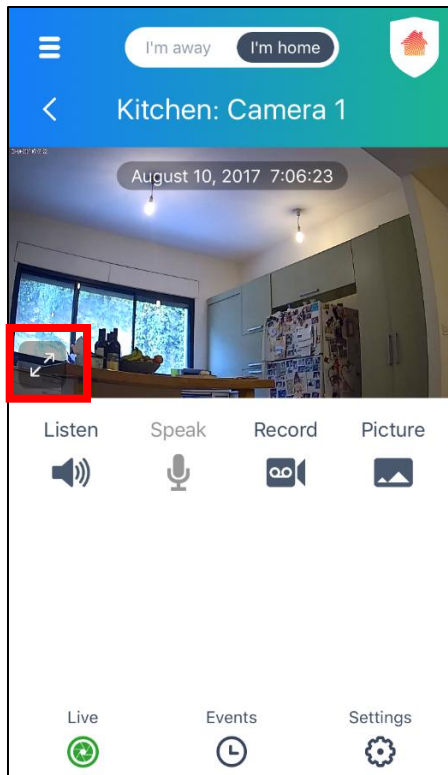

Live IP Camera View: Full Screen View, Landscape

Tap the ▢ **Options** expand button to open and view the options as shown below.



Live IP Camera View: Full Screen View, Landscape

Expanded Options view.

Tap the ↖ **Exit** full screen button to return to the Live IP Camera screen.

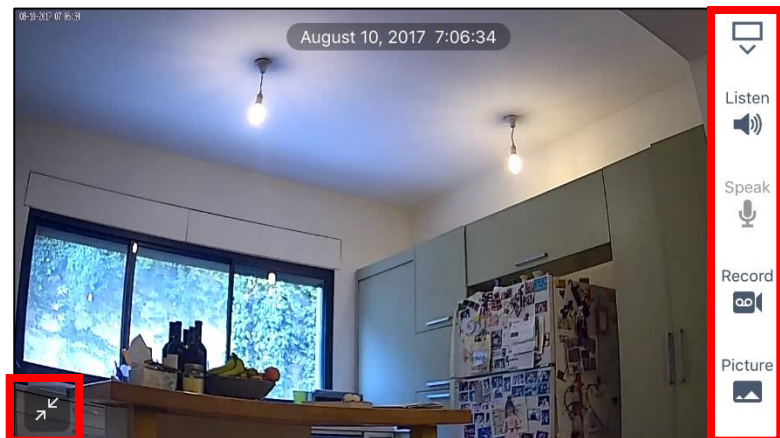

# Using your Device with Amazon Alexa



## Group 1 : IP Cameras

With the **Vivitar Home Cameras** Alexa skill you can easily control your Vivitar IP Cameras using Alexa voice commands.

Ask Alexa to modify your camera's motion detection and sound detection settings and sensitivity. These modifications will also be reflected in the Vivitar Smart Home Security app.

### GETTING STARTED

1. Open the **Vivitar Smart Home Security** app for Android or iOS.
2. Make sure that you have created a  Group 1 account and have completed the setup for your Vivitar Smart IP Camera, using the **Vivitar Smart Home Security** app.
3. Connect your Vivitar Smart IP Camera to the same Wi-Fi network as your Alexa device.
4. Download the **Amazon Alexa** app on your mobile device.

### DISCOVERING THE VIVITAR SMART IP CAMERA WITH A SKILL

1. You can connect the Vivitar Smart Home device using the Alexa app.
2. Go to the **Menu**, and then select **Skills**.
3. Search and find the **Vivitar Home Cameras** Skill for your device, then select **Enable**.
4. Follow the on-screen instructions to complete the linking process.
5. Ask Alexa to discover your device. Say, "Alexa, discover my devices," or select **Add Device** in the Smart Home section of the Alexa app.
6. Your discovered Vivitar IP Camera is listed under the Smart Home section of the Alexa app.
7. You can now use an Alexa-enabled device to control your connected Vivitar Smart IP Cam.

## **SUPPORTED VOICE COMMANDS**

### GIVE VOICE COMMANDS TO ALEXA:

1. Use an Alexa-enabled device to control your connected Vivitar Smart IP Camera.
2. To start using the skill, simply use one of the voice commands listed below.

### USE THESE COMMANDS TO CONTROL YOUR VIVITAR SMART IP CAMERAS VIA ALEXA:

- “Alexa, ask Home Camera to open camera detection.”
- “Alexa, ask Home Camera to close camera detection.”
- “Alexa, ask Home Camera to open camera motion detection.”
- “Alexa, ask Home Camera to close the camera motion detection.”
- “Alexa, ask Home Camera to open the camera sound detection.”
- “Alexa, ask Home Camera to close the camera sound detection.”
- “Alexa, ask Home Camera to set camera detection sensitivity to low.”
- “Alexa, ask Home Camera to set camera detection sensitivity to medium.”
- “Alexa, ask Home Camera to set camera detection sensitivity to high.”

# Using your Device with Google Actions



## Group 1 : IP Cameras

The **Vivitar Smart Cameras** Google Action allows you to control your Vivitar IP Cameras. Ask the Google Home Assistant to modify your camera's motion detection and sound detection settings and sensitivity. These modifications will also be reflected in the **Vivitar Smart Home Security** app.

Get started by setting up your Vivitar IP Cameras and then control motion and sound detection using Google Assistant commands (invocations).

### WHAT YOU'LL NEED

- A Mobile Device.
- Vivitar IP Camera(s): Signed in and connected to the Vivitar Smart Home Security App.
- "OK Google" turned on.
- Internet Connection.

### GETTING STARTED

1. Use one of these supported **mobile devices**.
  - Android phones or tablets with OS 6.0 or higher  
For more information go to [Google Assistant Support](#) (Android)
  - iPhones and iPads with IOS 9.0 or higher with installed Google Assistant app  
For more information go to [Google Assistant Support](#) (iOS)
  - Google Home speakers and Google Home Mini speakers
  - Android TVs with OS 6.0 or higher
2. "OK Google" turned on.
3. Internet connection.
4. Vivitar Smart Home IP Camera(s).

## **SETTING UP YOUR VIVITAR SMART IP CAMERA**

If you haven't already done so, please set up your Vivitar Smart IP Camera(s) by following the steps below.

1. Open the **Vivitar Smart Home Security** app for Android or iOS.
2. Make sure that you have created a **1.** Group 1 Account and have completed the setup for your Vivitar Smart Home IP Camera using the **Vivitar Smart Home Security** app.
3. Connect the Vivitar Smart Home IP Camera to the same Wi-Fi network as your Google device.

NOTE: Please see [Vivitar IP Camera Setup](#) for further information.

## **GOOGLE ASSISTANT SETUP:**

Make sure to activate your Google assistant ("OK Google") on your phone.

For further instructions – see here: [Google Assistant Help - Settings](#)

## **CONNECTING YOUR VIVITAR SMART HOME DEVICE TO GOOGLE:**

1. To activate your Google Assistant and start a conversation say:  
"OK Google, talk to Vivitar Smart Cameras".
2. You will be prompted with the Vivitar Google Action – which will notify you that the account is not linked yet.  
Tap "Link Vivitar Smart Cameras to Google".
3. In the Login page, enter your Vivitar Smart Home Security app credentials – your **1.** Group 1 Account email and password – and then tap **Sign in**.

NOTE: This is the same account information you used to set up your Vivitar Smart Home IP Camera in your **Vivitar Smart Home Security** app.

4. Grant permission to Google Assistant by typing **Yes** or **OK**.
5. You are now ready to start controlling your Vivitar Smart Home IP Camera using Google Assistant commands.
6. To end the conversation, say "Exit".

## **GIVING VOICE COMMANDS TO GOOGLE ASSISTANT**

1. Use one of the [supported mobile devices](#).
2. To start a conversation, say “OK Google, talk to Vivitar Smart Cameras”.  
NOTE: For the Google Home speaker, you can use “Ok Google” and “Hey Google” interchangeably.
3. Say “Ok Google, show device” or “Scan for devices” to get a list of your devices.
4. Say your voice commands to the Google Assistant.
5. To end the conversation, say “Exit”.

Here are some sample phrases for the Vivitar Smart IP Cameras:

- “Turn on/off ‘camera name’ detection”
- “Turn on/off ‘room name’ detection”
- “Turn on/off ‘camera name’ sound detection”
- “Turn on/off ‘camera name’ motion detection”
- “Turn on/off camera motion detection”
- “Turn on/off camera sound detection”
- “Set ‘camera name’ detection sensitivity to low/medium/high”
- “Set camera sound detection sensitivity to low/medium/high”
- “Set camera motion detection sensitivity to low/medium/high”

NOTE:

- After allowing permissions, you'll be able to control camera settings (Motion/sound detection) via Google Assistant.
- You must start every session by saying “Talk to Vivitar Smart Cameras” to activate the Vivitar Google Action. Please see the online Google Assistant for Vivitar Smart Cameras: [Google Assistant: Vivitar Smart Cameras](#)

# Troubleshooting

ISSUE	SOLUTION
<p><b>Reconnecting to Camera:</b> Your camera is disconnected for one of the following reasons:</p> <ol style="list-style-type: none"><li>1. Wi-Fi on camera or phone was shut off.</li><li>2. Other network connection problems.</li><li>3. Camera was unplugged from its power source.</li><li>4. Connecting another phone to your camera.</li></ol>	<p>Verify that your camera is powered on and that your Wi-Fi network is working properly. Then, in the app, tap on your IP Camera to connect.</p> <p>NOTE: Select your IP Camera either from the 'IP Cameras' screen or tap on IP Cameras from the 'Devices' screen.</p> <p>If the above solution does not work then please try the instructions below:</p> <ol style="list-style-type: none"><li>1. Disconnect the camera from the power supply. Exit the app. Reconnect the camera and relaunch the application. If this solution does not work, reset your camera as described below.</li><li>2. Reset your camera: Click on the reset button for 5 seconds to perform a 'Short reset', at this point you should see the blue light blinking rapidly. Try and reconnect by selecting 'Add new camera' and follow the instructions to add your camera again. In case 'Short reset' doesn't help, perform a 'Long reset' by pressing on the 'Reset' button for 10 seconds and then wait 1 minute, try and connect by selecting 'Add new Camera' and add your camera again by following the instructions on the screen.</li></ol> <p>If you are connecting with a different phone to the camera, you need to make sure your phone is connected to the same Wi-Fi network as the camera was connected at the initial setup (unless someone sent you a QR code for the camera, in which case you will not need to follow through this step).</p> <p>Please see <a href="#">Reconnecting Devices</a> for additional instructions.</p>

ISSUE	SOLUTION
<p><b>Your Micro SD Card is not recognized by the application.</b></p>	<p>Unplug the USB cable from the device, then plug the cable into power source. NOTE: Make sure that the memory card is inserted <u>before</u> the device is connected and before the Vivitar Smart Home Security app is launched.</p>
<p><b>Connection Failed:</b> You have switched the Wi-Fi connection on your phone and cannot connect to the camera.</p>	<ol style="list-style-type: none"> <li>1. Exit the app on your phone.</li> <li>2. Go to Wi-Fi settings on your phone and switch to a different Wi-Fi network (make sure it's not the same Wi-Fi network you connected the camera to initially).</li> <li>3. Launch the Vivitar Smart Home Security app on your phone. Your mobile device should reconnect automatically.</li> </ol>
<p><b>Connection Failed:</b> You have switched the Wi-Fi connection on your camera.</p>	<ol style="list-style-type: none"> <li>1. Exit the Vivitar Smart Home Security app on your mobile device.</li> <li>2. Go to Wi-Fi settings on your phone and select the Wi-Fi network you wish to connect to.</li> <li>3. Use the RESET tool to push and hold the 'Reset' button found on the back of the camera for 10 seconds.</li> <li>4. Wait 1 minute until the red light is blinking rapidly above the camera lens.</li> <li>5. Open the app and select "Add new device". Follow the on-screen instructions. Make sure to enter the correct Wi-Fi credentials.</li> <li>6. Tap the 'Done' button once you have successfully added your IP Camera.</li> <li>7. Your camera should now be connected.</li> </ol>

ISSUE	SOLUTION
<p><b>Problem with adding a new IP Camera to the app:</b>            Wi-Fi- connection is not working when adding a new IP Camera to the Vivitar Smart Home Security app.</p>	<ol style="list-style-type: none"> <li>1. The app is supported only on a 2.4GHz Wi-Fi network. Please ensure that your mobile device is set to a 2.4GHz Wi-Fi network and try again.                NOTE: When adding the IP Camera, try standing close to the router to maximize the Wi-Fi signal strength.</li> <li>2. If your IP Camera is not connecting with 2.4GHz Wi-Fi network and you are still having trouble adding a new IP Camera, this may be a temporary connection server issue, please try again later.</li> <li>3. An IP Camera that was registered to a different 'Group 1' account cannot be newly added to your account until it is removed from the first account. To add it to your account after the removal, you will need to do a long reset to the IP Camera. Please see <a href="#">Long Reset</a> for more further instructions. Changing to a different Wi-Fi network also requires removing the IP Camera from an account and doing a long reset.                NOTE: To check if an IP camera is already added to a different account, add the IP Camera by scanning the barcode option and you will then get a message with the correct account email address.</li> </ol>
<p><b>Problem viewing live video stream.</b></p>	<ol style="list-style-type: none"> <li>1. A problem viewing the live video stream may be a temporary connection server issue, please try again in a few minutes.</li> <li>2. If you are using cellular network or a public Wi-Fi network, then you need to make sure that your network speed and signal strength is strong to view the live video stream.</li> <li>3. Additionally, go to the IP Camera 'Settings' in the app and tap 'Restart' and wait a few minutes before trying to view the live video stream.</li> </ol>
<p><b>Problem registering a new account.</b></p>	<ol style="list-style-type: none"> <li>1. Please make sure that you are registering a new 'Group 1' account.</li> <li>2. Please try registering a new 'Group 1' account later, this may be a temporary connection server issue.</li> </ol>

ISSUE	SOLUTION
<p><b>Unable to receive the 'Forgot password' verification code for my account.</b></p>	<ol style="list-style-type: none"> <li>1. Make sure that you are tapping 'Forgot password' in the 'Group 1' account sign in screen.</li> <li>2. Make sure that you enter the correct email address used for this account.</li> <li>3. Check your spam email folder for the verification code email.</li> <li>4. Try tapping 'Forgot password' later, there may be a temporary connection server issue.</li> </ol>
<p><b>IP Camera Sound Issue:</b> Sound cannot be heard from the IP Camera.</p>	<ol style="list-style-type: none"> <li>1. Please make sure that the 'Listen' option is enabled in the Live IP Camera view in the Smart Home Security app.</li> <li>2. Also make sure that your mobile device is not on 'Silent' mode and audio is playable on other apps on your mobile device.</li> </ol>

## Camera Technical Specifications

Image Sensor	2.0MP
Video Resolution	1080P
Photo Resolution	596 x 333
External Memory	Micro SD Card (up to 32GB) – Class 4 or higher
Lens	Fixed Focus ; f=2.4mm
USB Interface	Micro USB

## Technical Support

For technical support issues please visit our website at [www.vivitar.com](http://www.vivitar.com) . You can find manuals, software and FAQ's at the website. Can't find what you are looking for? E-mail us at [support@vivitar.com](mailto:support@vivitar.com) and one of our technical support team members will answer your questions. For phone support in the US please call 1-800-592-9541 and in Australia call 1800-006-614. If you would like to call from anywhere else, please visit [www.vivitar.com](http://www.vivitar.com) for your local toll-free number.

# Sakar Warranty Card

This warranty covers for the original consumer purchaser only and is not transferable. Products that fail to function properly **UNDER NORMAL USAGE**, due to defects in material or workmanship will be repaired at no charge for parts or labor for a period of one year from the time of purchase.

## What Is Not Covered By Warranty:

Damages or malfunctions not resulting from defects in material or workmanship and damages or malfunctions from other than normal use, including but limited to, repair by unauthorized parties, tampering, modification or accident.

## What To Do When Service Is Required:

When returning your defective product (postage pre-paid) for service, your package should include:

3. Copy of **original** bill of sale.
4. A detailed written description of the problem.
5. Your return address and telephone number (Daytime).

## MAIL TO ADDRESS BELOW:

<u>Sakar US</u> Sakar International Attention: Service Department 195 Carter Drive Edison, NJ 08817	<u>Sakar Australia</u> Return faulty camera to the Refund Counter at the store where purchased
--	--

## Remark:

Product and software are updated periodically. The application interface in this manual are only for example. No extra notification on further changes.

## **FCC Statement**

Changes or modifications not expressly approved by the party responsible for compliance could void the user's authority to operate the equipment.

This device complies with Part 15 of the FCC Rules. Operation is subject to the following two conditions: (1) this device may not cause harmful interference, and (2) this device must accept any interference received, including interference that may cause undesired operation.

This equipment has been tested and found to comply with the limits for a Class B digital device, pursuant to Part 15 of the FCC Rules. These limits are designed to provide reasonable protection against harmful interference in a residential installation. This equipment generates, uses and can radiate radio frequency energy and, if not installed and used in accordance with the instructions, may cause harmful interference to radio communications. However, there is no guarantee that interference will not occur in a particular installation.

If this equipment does cause harmful interference to radio or television reception, which can be determined by turning the equipment off and on, the user is encouraged to try to correct the interference by one or more of the following measures:

- Reorient or relocate the receiving antenna.
- Increase the separation between the equipment and receiver.
- Connect the equipment into an outlet on a circuit different from that to which the receiver is connected.
- Consult the dealer or an experienced radio/TV technician for help.