













Assembly Instruction

ASHFORD X BACK SIDE CHAIR

HARDWARE PARTS:

 Pan Head Screw 4 pcs	 (Short) JCBC Bolt 2 pcs	 (Long) JCBC Bolt 8pcs	 Lock Washer 10 pcs	 Flat Washer 10 pcs	 Allen Key 1 pce	 Glue 1 pce
---	---	---	--	--	---	---

PARTS LIST

SKETCH	DESCRIPTION	Q'TY
	Chair Back	1 pc
	Seat	1 pc
	Front Leg Left	1 pc
	Front Leg Right	1 pc
	Side Stretcher (Right)	1 pc
	Side Stretcher (Left)	1 pc

ASSEMBLY:

- Position the chair back on a soft surface such as a carpet. Place the chair apron frame on to the middle rail of the chair back with the dowel fully inserted into the pre-drilled holes. Make sure that the screw holes on the apron frame are facing down.
 - Insert JCBC Bolt (Long) through a Lock Washer and a Flat Washer into the pre-drilled holes on the apron frame at rear corners.
 - Insert the JCBC Bolt (Short) through a Lock Washer and a Flat Washer into the pre-drilled holes on the apron frame at rear rail.
- Apply Glue to all the pre-drilled holes before attaching all stretcher. Insert each side stretcher into pre-drilled holes on both of the rear legs, make sure that screw holes on the stretcher are facing down. Place the assembled front legs to corner block of the frame, and insert side stretcher into legs.
 - Insert the JCBC Bolt (Long) through a Lock Washer, a Flat Washer and the pre-drilled holes of corner block into the pre-drilled holes on the front leg, use the provided Allen Key but do not fully tighten the bolts yet.
 - Insert Pan Head Screw into side stretcher through the pre-drilled holes, tighten with screw-driver (Not Provided).

STEP 1

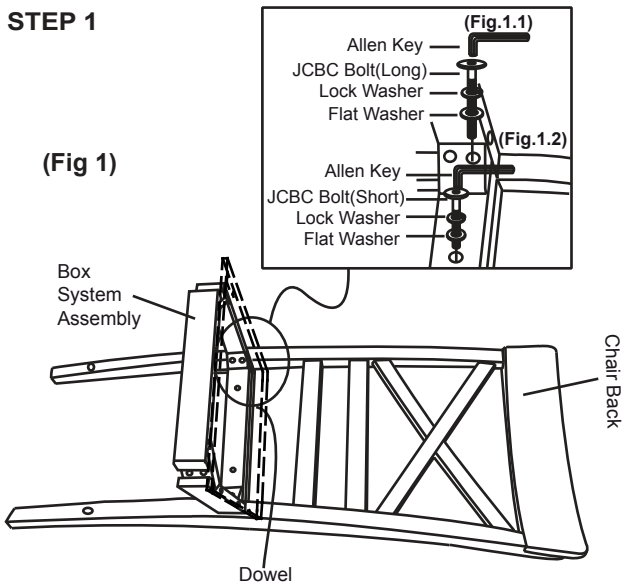

DO NOT TIGHTEN SCREWS YET AT THIS STEP

STEP 2

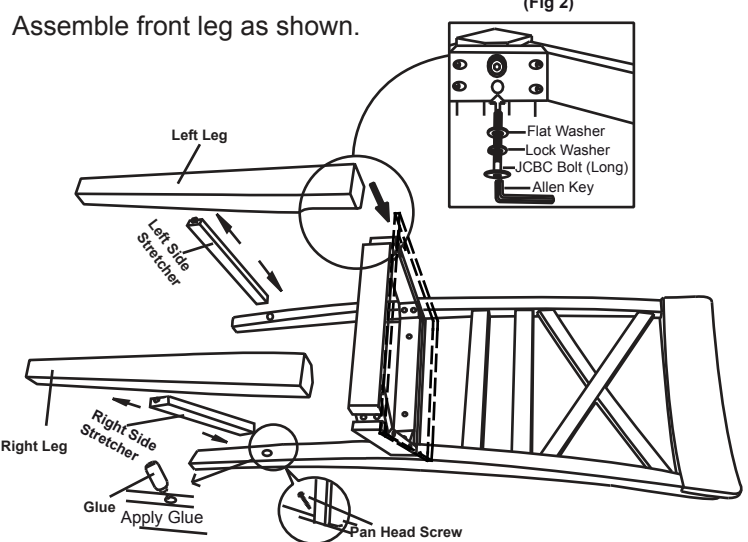

DO NOT TIGHTEN SCREWS YET AT THIS STEP

STEP 3

Turn the chair upright. Check its balance and tighten all screws and bolts to complete the assembly.



PREVENTATIVE MAINTENANCE AND WARNING

- USE THIS PRODUCT ONLY FOR SEATING ONE PERSON AT TIME.
- DO NOT USE THIS PRODUCT AS A STEP STOOL / LADDER.
- DO NOT SIT ON ANY PART OF THIS PRODUCT EXCEPT SEAT.
- DO NOT USE THIS PRODUCT ON UNEVEN FLOOR SURFACES.
- DO NOT USE THIS PRODUCT UNLESS ALL SCREWS AND BOLTS ARE TIGHT. AT LEAST EVERY 6 WEEKS CHECK ALL SCREWS AND BOLTS TO MAKE SURE THEY ARE TIGHT.
- IF ANY PARTS ARE MISSING, BROKEN, DAMAGED OR WORN STOP USE OF THIS PRODUCT UNTIL REPAIRS ARE MADE.
- DISPOSE OF PACKAGING PROPERLY. PLASTIC BAG IS NOT A TOY. DO NOT USE PLASTIC BAG AS A HEAD COVERING. IT MAY CAUSE SUFFOCATION.
- FAILURE TO FOLLOW THESE WARNINGS COULD RESULT IN SERIOUS INJURY.

Use of Power Tools is Not Recommended. Max Capacity 250 LBS.

This item does not meet Commercial use standards. All commercial use will void all warranties.

MADE IN MALAYSIA