



1000N • 1200N • 2000N • 2200N
 2600N+ • 2800N+
 3100N+ • 3200N+

ULPG OWNER'S MANUAL



REGISTER TODAY - SCAN THE QR CODE

Unlock barbecuing happiness: Register your gas barbecue and receive special content to make you the ultimate backyard hero.

Registration is easy and we only ask a few quick questions. In less than two minutes, unlock a lifetime of WEBER knowledge and guidance. Stay inspired along the way.

Important Safety Information

DANGER, WARNING, and CAUTION statements are used throughout this Owner's Manual to emphasise critical and important information. Read and follow these statements to help ensure safety and prevent property damage. The statements are defined below.

⚠ DANGER: Indicates a hazardous situation which, if not avoided, *will result in death or serious injury.*

⚠ WARNING: Indicates a hazardous situation which, if not avoided, *could result in death or serious injury.*

⚠ CAUTION: Indicates a hazardous situation which, if not avoided, *could result in minor or moderate injury.*

USE OUTDOORS ONLY.

READ THE INSTRUCTIONS BEFORE USING THE APPLIANCE.

NOTICE TO INSTALLER: These instructions must be left with the consumer.

NOTICE TO CONSUMER: Retain these instructions for future reference.

⚠ DANGER

If you smell gas:

- Shut off gas to the appliance.
- Extinguish any open flame.
- Open lid.
- If odour continues, keep away from the appliance and immediately call your gas supplier or the emergency fire services.

⚠ WARNING

- Do not store or use gasoline or other flammable liquids or vapours in the vicinity of this or any other appliance.
- A cylinder not connected for use shall not be stored in the vicinity of this or any other appliance.

Operation

ONLY USE IN WELL-VENTILATED AREAS.

CARBON MONOXIDE HAZARD—USING THIS APPLIANCE IN AN ENCLOSED SPACE MAY CAUSE DEATH. DO NOT USE IN CARAVANS, TENTS, MARINE CRAFT, CARS, MOBILE HOMES OR SIMILAR LOCATIONS.

⚠ DANGER: Only use the barbecue outdoors in a well-ventilated area. Do not use in a garage, building, breezeway, tent, any other enclosed area, or beneath overhead combustible construction.

⚠ DANGER: Do not use the barbecue in any vehicle or in any storage or cargo area of any vehicle. This includes, but is not limited to, cars, trucks, station wagons, mini-vans, sport utility vehicles, recreational vehicles, and boats.

⚠ DANGER: Do not use the barbecue within 61 cm (24 inches) of combustible materials. This includes the top, bottom, back and sides of the barbecue.

⚠ DANGER: Keep the cooking area clear of flammable vapours and liquids such as petrol, alcohol, etc., and combustible materials.

⚠ DANGER: This appliance must be kept away from flammable materials during use. Do not spray aerosols in the vicinity of this barbecue while it is in operation.

⚠ DANGER: Do not put a barbecue cover or anything flammable on, or in the storage area under the barbecue while it is in operation or is hot.

⚠ DANGER: Should a grease fire occur, turn off all burners and leave lid closed until fire is out.

⚠ WARNING: Accessible parts may be very hot. Keep young children away.

⚠ WARNING: The use of alcohol, prescription drugs, non-prescription drugs, or illegal drugs may impair the consumer's ability to properly and safely assemble, move, store, or operate the barbecue.

⚠ WARNING: Never leave the barbecue unattended during pre-heating or use. Exercise caution when using this barbecue. The entire cookbox gets hot when in use.

⚠ WARNING: Do not move the appliance during use.

⚠ WARNING: Keep any electrical supply cord and the fuel supply hose away from any heated surfaces.

⚠ WARNING: Do not place articles on or against this barbecue.

⚠ CAUTION: This product has been safety-tested and is only certified for use in a specific country. Refer to country designation located on outside of box.

• Do not use charcoal, briquettes or lava rock in the barbecue.

Storage and/or Nonuse

⚠ WARNING: Turn off the gas supply at the cylinder after use.

⚠ WARNING: Cylinders must be stored outdoors out of the reach of children and must not be stored in a building, garage or any other enclosed space.

⚠ WARNING: After a period of storage and/or nonuse, the barbecue should be checked for gas leaks and burner obstructions before use.

• Storage of the barbecue indoors is permissible only if the cylinder is disconnected and removed from the barbecue.

Important: Read these instructions for use carefully. Familiarise yourself with the appliance before connecting it to its gas container. Keep these instructions for future reference.

Installation and Assembly

⚠ DANGER: This barbecue is not intended to be installed in or on recreational vehicles or boats.

⚠ WARNING: Do not use this barbecue unless all parts are in place and the barbecue was properly assembled according to the assembly instructions.

⚠ WARNING: Do not build this model of barbecue in any built-in or slide-in construction.

⚠ WARNING: Do not modify the appliance. LP gas is not natural gas. The conversion or attempted use of natural gas in a LP gas unit or LP gas in a natural gas unit is unsafe and will void your warranty.

⚠ Remove all packaging materials and protective film before operating your barbecue.

• The installation of the barbecue must conform with the requirements of AS/NZS 5601 and the local authority – gas or electricity, etc.

• Do not install in, or connect to the consumer piping or gas supply of a boat or caravan.

• Any parts sealed by the manufacturer must not be altered by the user.



FEATURES OF THIS BARBECUE

To access complete user information, scan the QR Code and enter your serial number, or browse online at weber.com/literature-online

Serial Number

Serial Number

Write your barbecue's serial number in the box above for future reference. The serial number is on the barbecue's data label.



30859_072723 enAUNZ



GETTING STARTED

Considerations for Locating your Barbecue

Any enclosure in which the appliance is used shall comply with one of the following:

- An enclosure with walls on all sides, but at least one permanent opening at ground level and no overhead cover (A).
- Within a partial enclosure that includes an overhead cover and no more than two walls (B).
- Within a partial enclosure that includes an overhead cover and more than two walls, the following shall apply (C):
 - (i) at least 25% of the total wall area is completely open; and
 - (ii) at least 30% of the remaining wall area is open and unrestricted.
- In the case of balconies, at least 20% of the total of the side, back and front wall areas shall be and remain open and unrestricted.

Important Information about ULPG & Gas Connections

Universal liquefied petroleum gas, also called ULPG, LP gas, liquid propane, or simply propane or butane, is the flammable, petroleum-based product used to fuel your barbecue. It is a gas at moderate temperatures and pressure when it is not contained. But at moderate pressure inside a container, such as a tank, LP is a liquid. As pressure is released from the tank, the liquid readily vapourises and becomes gas.

Safe Handling Tips for ULPG Cylinders

There are various guidelines and safety factors that you need to keep in mind when using ULPG. Carefully follow these instructions before using your gas barbecue.

- Do not use a damaged cylinder. A dented or rusty cylinder or a cylinder with a damaged valve may be hazardous and should be replaced with a new cylinder immediately.
- Handle "empty" cylinders with the same care as you handle full cylinders. Even when a cylinder is empty of liquid, there may still be gas pressure inside the cylinder.
- Cylinders should not be dropped or handled roughly.
- Never store or transport the cylinder where temperatures can reach 51° C (the cylinder will become too hot to hold by hand). For example: do not leave the cylinder in a car on a hot day.
- Check that seals between the appliance and the gas container are in place and in good condition before connecting the gas container.
- Do not use this appliance if it has damaged or worn seals.
- Do not use this appliance if it is leaking, damaged or does not operate properly.
- Leak-test the joint where the regulator connects to the cylinder each time a reconnection occurs. For example: test each time the cylinder is reinstalled.
- Store cylinders outdoors in a well-ventilated area out of the reach of children. Any indoor storage must comply with AS/NZS 1596.
- Do not connect to natural gas supply (city gas). The valves and orifices are designed exclusively for ULP gas.
- The areas around the cylinder must be free and clear from debris.
- The cylinder should be changed in a well-ventilated location, preferably outside away from people and any sources of ignition, such as naked flames, pilot flames, electric heaters/equipment.
- To check for gas in the cylinder, liquid fuel may be heard or detected when the container is gently shaken.

Additional Tips for Cylinders

- Always close the cylinder valve before disconnecting the cylinder from the adapter hose.
- Cylinders must be installed, transported, and stored in an upright position.
- Routinely check the cylinder to ensure the test date has not expired. Do not use a cylinder which has an expired test date.

What is a Regulator?

Your gas barbecue is equipped with a pressure regulator, which is a device to control and maintain uniform gas pressure as gas is released from the gas cylinder.

A

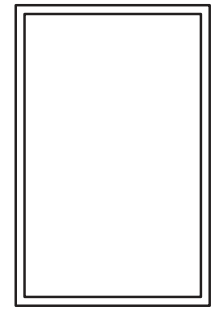
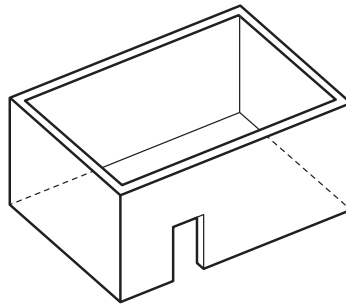

B

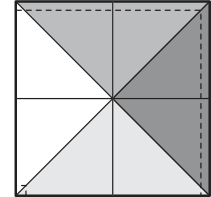
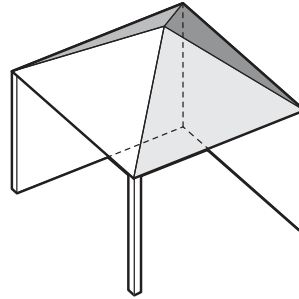

Both ends open

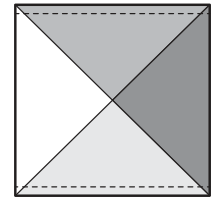
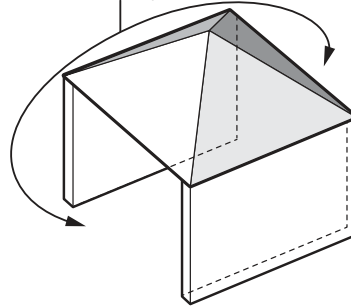

C

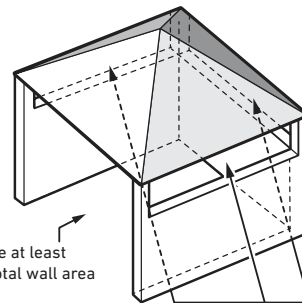

Open side at least 25% of total wall area

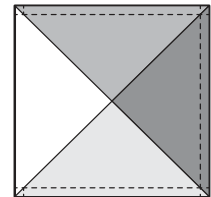

30% or more in total of the remaining wall area is open and unrestricted

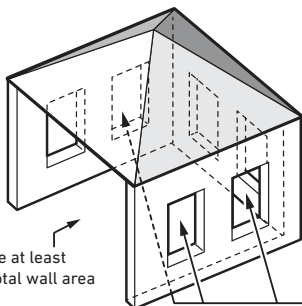

Open side at least 25% of total wall area

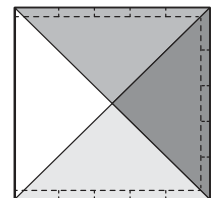

30% or more in total of the remaining wall area is open and unrestricted

△ IMPORTANT: This appliance shall only be used in an above ground open-air situation with natural ventilation, without stagnant areas, where gas leakage and products of combustion are rapidly dispersed by wind and natural convection.



Regulator Connections

Requirements for Cylinders

- Any parts sealed by the manufacturer must not be altered by the user.
- Any modification of the appliance may be dangerous.

Additional Requirements for Cylinders

- Avoid kinking the hose.
- Change the flexible hose when national regulations stipulate this as a requirement.
- Only a nationally approved low-pressure hose and regulator must be used.
- Replacement regulator and hose assemblies must be as specified by Weber-Stephen Products LLC.

ULPG Cylinder Installation

While using the gas hose, use care to route the gas hose away from the cookbox and other hot surfaces.

Only use the hose assembly as supplied with this appliance for connection to the cylinder - DO NOT USE ADAPTORS.

Cylinder Requirements

- Use cylinders with a maximum capacity of 9 kg.

Inspect the Cylinder

Check the ULPG cylinder before use to ensure a proper gas connection.

- Confirm that the ULPG cylinder valve is fully closed. Close by turning valve clockwise.
- Inspect the ULPG cylinder valve for damage or debris. Take special notice of the condition of the internal O-ring (A). If damaged, return ULPG cylinder to local retailer.
- Confirm that the ULPG cylinder valve is the proper mating type for the gas hose (B).

Cylinder Installation

- 1) Place the ULPG cylinder on the ground behind the barbecue or on the barbecue stand.
- 2) Turn the ULPG cylinder so the opening of the valve faces the side or back of the barbecue.

Connect the Gas Hose to the Cylinder

- 1) Check that the burner control knob(s) is(are) in the off \circ position. Check by pushing in and turning knob(s) clockwise.
- 2) Connect the gas hose coupling to the ULPG cylinder. Hand tighten only.
 - a) Tighten by turning the fitting clockwise (C).

Cylinder Connection

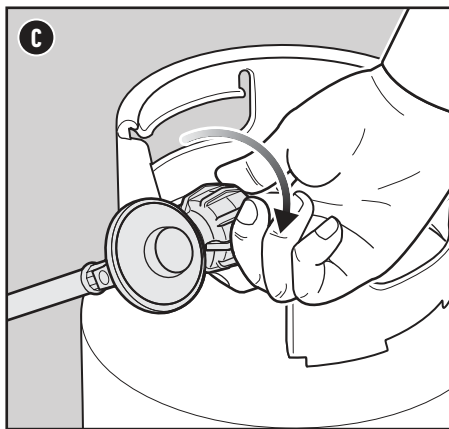
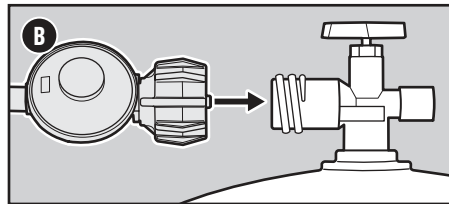
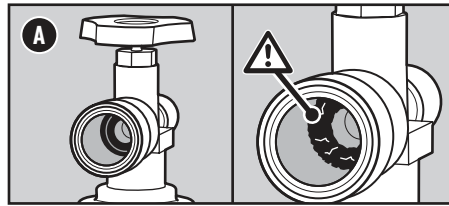
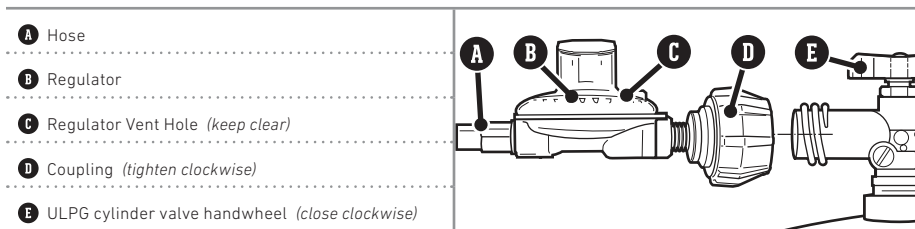

ULPG Cylinder Installation Using the Premium Cart

This feature is only available on select models.

⚠ While using the premium cart, the cylinder must be secured inside the cart.

Cylinder Requirements

- Use cylinders with a maximum capacity of 9 kg.

Cylinder Installation

- 1) Open the door of the premium cart.
- 2) Lift cylinder into position inside the cart (D).
- 3) Turn the ULPG cylinder so the opening of the valve faces the inside of the barbecue stand.
- 4) Secure the cylinder by tightening the hand wheel on the base of the cart (E).

Connect the Gas Hose to the Cylinder

- 1) Check that the burner control knobs are in the off \circ position. Check by pushing in and turning knobs clockwise.
- 2) Connect the gas hose coupling to the ULPG cylinder. Hand tighten only.
 - a) Tighten by turning the fitting clockwise (C).

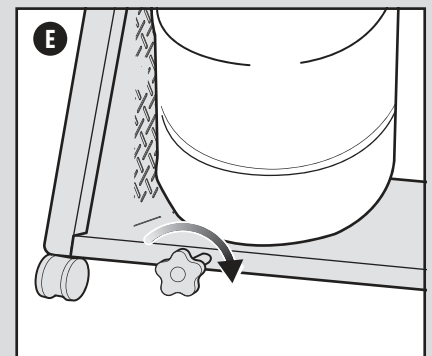
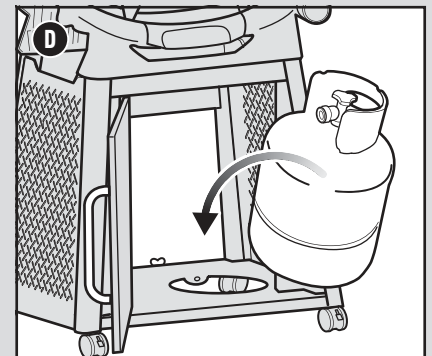

Burner Valve Orifice Sizes & Consumption Data

Gas Category	BURNER VALVE ORIFICE SIZES		
	1000N/1200N	2000N/2200N	
2.8 kPa	Main Burner 0.93 mm	Main Burner 1.07 mm	
	2600N+/2800N+	3100N+/3200N+	
	Main Burner 1.09 mm	Main Burner 1.23 mm	
	Sear Burner 0.58 mm	Sear Burner 0.58 mm	
TOTAL CONSUMPTION DATA			
1000N/1200N	2000N/2200N	2600N+/2800N+	3100N+/3200N+
10.6 Mj/h	14.8 Mj/h	19.0 Mj/h	23.2 Mj/h

⚠ WARNING: It may be hazardous to attempt to fit other types of gas containers.

⚠ IMPORTANT: We recommend that you replace the gas hose assembly on your gas barbecue every five years. Some countries may have requirements that the gas hose be replaced within less than five years, in which case that country's requirement would take precedence.

For replacement hose, regulator, and valve assemblies, contact the Customer Service Representative in your area using the contact information on our web site. Log on to weber.com.

⚠ This appliance is not suitable for installation or connection to a reticulated gas supply.



OPERATION

Conducting a Leak Check

Once the ULPG cylinder is properly installed, it is necessary to perform a leak check. A leak check is a reliable way to verify that gas is not escaping after you connect the ULPG cylinder. Weber recommends performing a thorough leak check after assembly, as well as annually. The following fittings should be tested:

- Where the cylinder connects to the regulator.
- Where the regulator connects to the gas hose.
- Where the gas hose connects to the burner valve.

Checking for Gas Leaks

If there is a leak from your appliance (smell of gas) immediately attempt to turn off the cylinder valve. Remove the appliance to a well-ventilated location away from any ignition source. Check for leaks using soapy water. Do not try to detect leaks using a flame.

- 1) Wet fittings (A) with a soap and water solution, using a spray bottle, brush, or rag. You can make your own soap and water solution by mixing 20% liquid soap with 80% water; or, you can purchase leak check solution in the plumbing section of any hardware store.
- 2) Slowly open gas supply by turning cylinder valve anti-clockwise while checking for bubbles.
- 3) If bubbles appear there is a leak:
 - a) If the leak is at the cylinder (B), turn off the gas. Disconnect the regulator, then reconnect and test. If the leak persists DO NOT OPERATE THE BARBECUE. Disconnect the ULPG cylinder. Contact the Customer Service Representative in your area using the contact information on our website.
 - b) If the leak is at regulator (C), or at the fitting indicated in illustration (D), DO NOT OPERATE THE BARBECUE. Contact the Customer Service Representative in your area using the contact information on our website.

If a leak is present, contact the Customer Service Representative in your area using the contact information on our website.

- 4) If bubbles do not appear, leak checking is complete:
 - a) Turn gas supply off at the ULPG cylinder and rinse connections with water.

NOTE: Since some leak test solutions, including soap and water, may be slightly corrosive, all connections should be rinsed with water after checking for leaks.

Refilling or Replacing an ULPG Cylinder

Removing the ULPG Cylinder

Every time your ULPG cylinder needs to be refilled or replaced, follow these instructions to remove it.

- 1) Confirm that the cylinder valve is fully closed. Close by turning valve clockwise.
- 2) Unscrew gas hose coupling from the cylinder.

Additional Leak Check Precautions

The following fittings should be tested for gas leaks each time an ULPG cylinder is refilled and reinstalled:

- Where the regulator connects to the cylinder (B) and at the regulator (C).

Follow the instructions for "Checking for Gas Leaks".

- ⚠ **DANGER:** Do not use a flame to check for gas leaks. Be sure there are no sparks or open flames in the area while you check for leaks.
- ⚠ **DANGER:** Leaking gas may cause a fire or explosion.
- ⚠ **DANGER:** Do not operate the barbecue if there is a gas leak present.
- ⚠ **DANGER:** If you see, smell, or hear the hiss of gas escaping from the cylinder:
 1. Move away from cylinder.
 2. Do not attempt to correct the problem yourself.
 3. Call the emergency fire services.
- ⚠ **DANGER:** Always close the cylinder valve before disconnecting the regulator. Do not attempt to disconnect the gas regulator and hose assembly or any gas fitting while this barbecue is in operation.
- ⚠ **DANGER:** Do not store a spare cylinder under or near this barbecue. Never fill the cylinder beyond 80% full. Failure to follow these statements exactly may result in a fire causing death or serious injury.

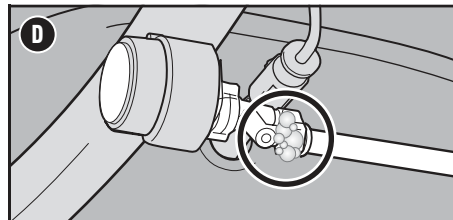
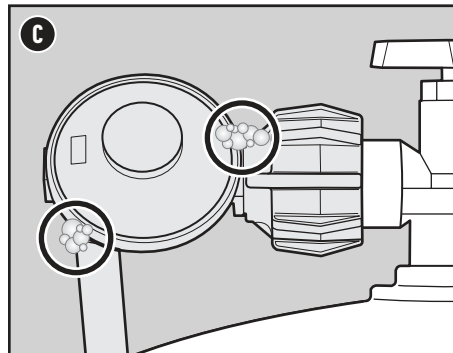
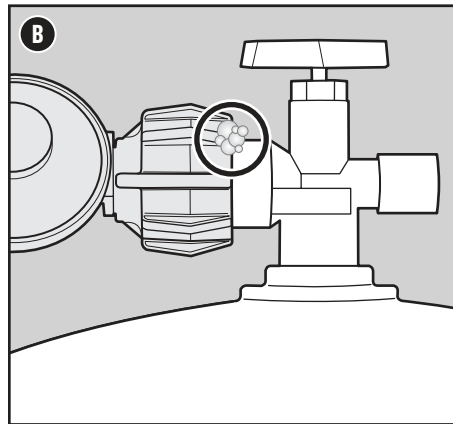
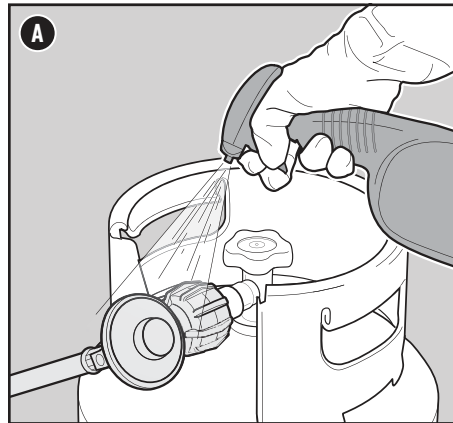

Igniting the Barbecue

Using the Ignition System to Ignite the Main Burner

The ignition system ignites the burner with a spark from the igniter electrode. You generate the energy for the spark by pushing the igniter button. You will hear the igniter ticking.

- 1) Open the barbecue lid (A).
- 2) Check that the burner control knobs are in the off position. Check by pushing in and turning each knob clockwise (B).
- 3) Confirm that the cylinder is properly installed and gas is on. Refer to "ULPG Cylinder Installation."
- 4) Push the main burner control knob in and turn it counterclockwise to the start/high position (C).

- 5A) Push the red igniter button several times, so it clicks each time (D).
- 5B) Push and hold the electronic igniter button (E). You will hear it ticking.

- 6) Check that the burner is lit by looking through the cooking grills. You should see a flame.
- 7) If the burner does not ignite within 5 seconds, turn burner control knob to the off position and wait five minutes to allow the gas to clear before attempting to light the burner again.

Should the burner fail to ignite using the ignition system, refer to the TROUBLESHOOTING section. There you will find instructions on igniting the barbecue with a match to help determine the exact problem.

Preheating the Barbecue

Preheating the barbecue is critical to successful barbecuing. Preheating helps to prevent food from sticking to the grills and gets the grills hot enough to sear properly. It also burns off residue of a previously cooked meal.

- 1) Open the barbecue lid.
- 2) Ignite your barbecue according to the ignition instructions in this Owner's Manual.
- 3) Close lid.
- 4) Preheat the barbecue with the burners on the start/high position for 10 to 15 minutes or until thermometer registers 260° C (500° F) (C).
- 5) After preheating on high is complete, you may adjust the burner control knob to your desired setting for barbecuing.

To Extinguish Burner

- 1) Push the burner control knob in and then turn clockwise all the way to the off position.
- 2) Turn gas supply off.

Burner Control Knob Settings

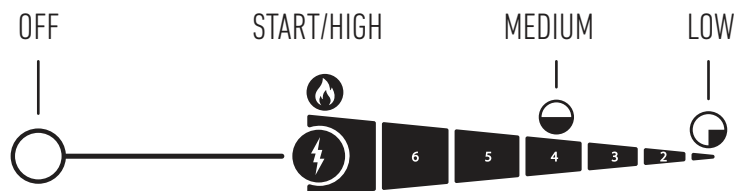

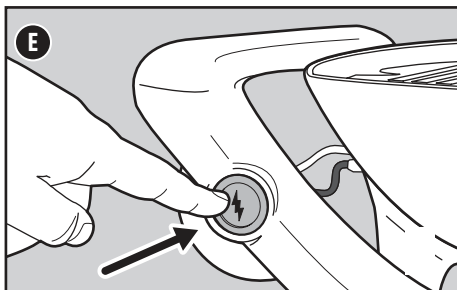
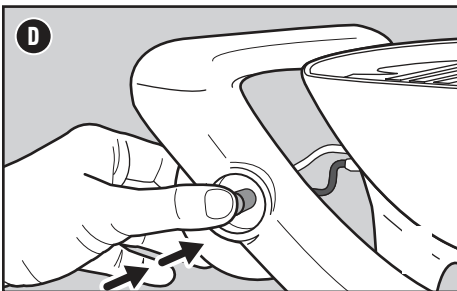
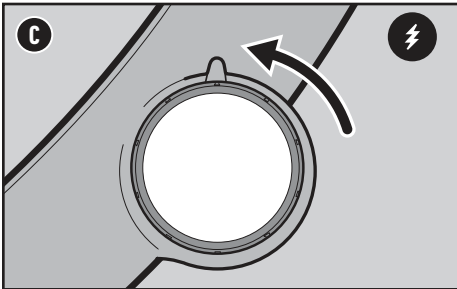
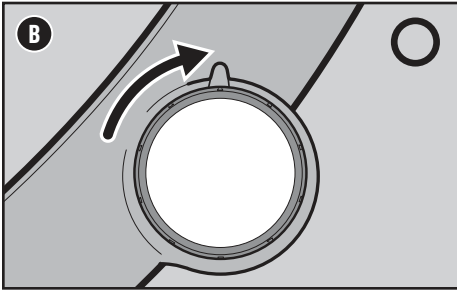
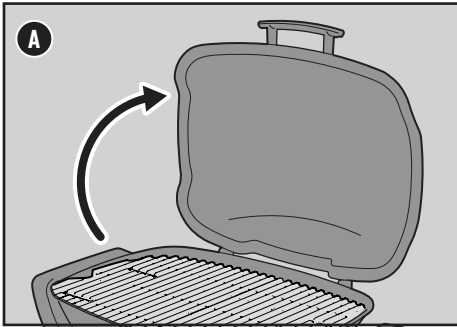

⚠ **WARNING:** Open lid during ignition.
 ⚠ **WARNING:** Do not lean over open barbecue while igniting or cooking.
 ⚠ **WARNING:** If ignition does not occur within five seconds, turn the burner control knob to the off position. Wait five minutes to allow accumulated gas to dissipate, and then repeat the lighting procedure.

Using the + Burner

This feature is only available on select models.

The + burner provides the versatility of searing food at a high temperature when combined with the main burner, or low and slow cooking when using the + burner alone.

SEARING

- 1) Open the lid and ignite both burners including the + burner (A). Begin with igniting the main burner first.

IMPORTANT: Always ignite the main burner first. The + burner ignites from the main burner.

Refer to IGNITING THE BARBECUE.

- 2) Preheat the barbecue with the lid closed and with all burners on the high 🔥 position for 10 to 15 minutes or until thermometer registers 500° F (260° C).
- 3) After preheating, leave the + burner control knob and the main burner control knob in the high 🔥 position. The + burner works in tandem with the main burner (B).
- 4) Place food directly over the + burner and close lid. Refer to the cooking instructions provided in the Australian and New Zealand User Guide for your barbecue.

LOW AND SLOW

- 1) Open the lid and ignite both burners including the + burner. Begin with igniting the main burner first. **IMPORTANT: Always ignite the main burner first. The + burner ignites from the main burner.**

Refer to IGNITING THE BARBECUE.

- 2) Preheat the barbecue with the lid closed and with all burners on the high 🔥 position for 10 to 15 minutes or until thermometer registers 500° F (260° C).
- 3) After preheating, leave only the + burner control knob in the high 🔥 position and turn the main burner control knob off.
- 4) Refer to the cooking instructions provided in the Australian and New Zealand User Guide for your barbecue.

Note: Always cook with the lid closed to achieve maximum heat and to avoid flare-ups.

To Extinguish Burner(s)

- 1) Push burner control knob(s) in and then turn clockwise all the way to the off ○ position.
- 2) Turn gas supply off.

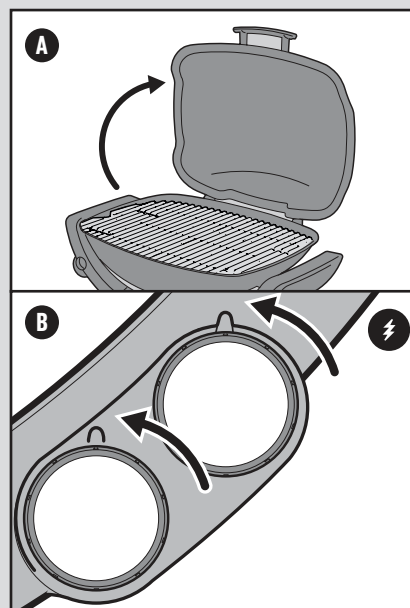

- Thank you for purchasing a WEBER product. Weber-Stephen Products LLC, 1415 S. Roselle Road, Palatine, Illinois 60067 ("WEBER") prides itself on delivering a safe, durable, and reliable product.

- This is WEBER'S Voluntary Warranty provided to you at no extra charge. It contains the information you will need to have your WEBER product repaired in the unlikely event of a failure or defect.

- Pursuant to the Australia Consumer Law, the Owner has several rights in case the product is defective. Those rights include that the product is fit for purpose, acceptable in appearance and finish, free from defects and is safe and durable. **These and other statutory rights remain unaffected by this warranty provision. In fact, this warranty grants additional rights to the Owner that are independent from statutory warranty provisions.**

WEBER'S VOLUNTARY WARRANTY

- WEBER warrants, to the purchaser of the WEBER product (or in the case of a gift or promotional situation, the person for whom it was purchased as a gift or promotional item), that the WEBER product is free from defects in material and workmanship for the period(s) of time specified below when assembled and operated in accordance with the accompanying Owner's Manual. (Note: If you lose or misplace your WEBER Owner's Manual, a replacement is available online at www.weber.com, or such country-specific website to which Owner may be redirected.) Under normal, private single family home or apartment use and maintenance, WEBER agrees within the framework of this warranty to repair or replace defective parts within the applicable time periods, limitations, and exclusions listed below. **TO THE EXTENT ALLOWABLE BY APPLICABLE LAW, THIS WARRANTY IS EXTENDED ONLY TO THE ORIGINAL PURCHASER AND IS NOT TRANSFERABLE TO SUBSEQUENT OWNERS, EXCEPT IN THE CASE OF GIFTS AND PROMOTIONAL ITEMS AS NOTED ABOVE.**

- Our goods come with guarantees that cannot be excluded under the Australian Consumer Law. You are entitled to a replacement or refund for a major failure and for compensation for any other reasonably foreseeable loss or damage. You are also entitled to have the goods repaired or replaced if the goods fail to be of acceptable quality and the failure does not amount to a major failure.

- The benefits given under this Limited Warranty are in addition to other rights and remedies you have under the Australian Consumer Law in relation to this WEBER gas barbecue.

OWNER'S RESPONSIBILITIES UNDER THIS WARRANTY

- To ensure trouble-free warranty coverage, it is important (but it is not required) that you register your WEBER product online at www.weber.com, or such country-specific website to which Owner may be redirected. Please also retain your original sales receipt and/or invoice. Registering your WEBER product confirms your warranty coverage and provides a direct link between you and WEBER in case we need to contact you.

- The above warranty only applies if the Owner takes reasonable care of the WEBER product by following all assembly instructions, usage instructions, and preventative maintenance as outlined in the accompanying Owner's Manual, unless the Owner can prove that the defect or failure is independent of non-compliance with the above mentioned obligations. If you live in a coastal area, or have your product located near a pool, maintenance includes regular washing and rinsing of the exterior surfaces as outlined in the accompanying Owner's Manual.

WARRANTY HANDLING / EXCLUSION OF WARRANTY

- If you believe that you have a part which is covered by this Warranty, please contact WEBER Customer Service using the contact information on our website (www.weber.com, or such country-specific website to which Owner may be redirected). WEBER will, upon investigation, repair or replace (at its option) a defective part that is covered by this Warranty. In the event that repair or replacement are not possible, WEBER may choose (at its option) to replace the barbecue in question with a new barbecue of equal or greater value. WEBER may ask you to return parts for inspection, shipping charges to be pre-paid.

- This WARRANTY lapses if there are damages, deteriorations, discolourations, and/or rust for which WEBER is not responsible caused by:

- Abuse, misuse, alteration, modification, misapplication, vandalism, neglect, improper assembly or installation, and failure to properly perform normal and routine maintenance;
- Insects (such as spiders) and rodents (such as squirrels), including but not limited to damage to burner tubes and/or gas hoses;
- Exposure to salt air and/or chlorine sources such as swimming pools and hot tubs/spas;
- Severe weather conditions such as hail, hurricanes, earthquakes, tsunamis or surges, tornadoes or severe storms.



WARRANTY

The use and/or installation of parts on your WEBER product that are not genuine WEBER parts will void this Warranty, and any damages that result hereby are not covered by this Warranty. Any conversion of a gas barbecue not authorised by WEBER and performed by a WEBER authorised service technician will void this Warranty.

PRODUCT WARRANTY PERIODS

Cookbox:
5 years, no rust through/burn through
(2 years paint, excluding fading or discoloration)

Lid assembly:
5 years, no rust through/burn through
(2 years paint, excluding fading or discoloration)

Stainless steel burner tubes:
5 years, no rust through/burn through

Porcelain-enameled cast iron cooking grills:
5 years, no rust through/burn through

Plastic components:
5 years, excluding fading or discoloration

All remaining parts:
2 years

DISCLAIMERS

APART FROM THE WARRANTY AND DISCLAIMERS AS DESCRIBED IN THIS WARRANTY STATEMENT, THERE ARE EXPLICITLY NO FURTHER WARRANTY OR VOLUNTARY DECLARATIONS OF LIABILITY GIVEN HERE WHICH GO BEYOND THE STATUTORY LIABILITY APPLYING TO WEBER. THE PRESENT WARRANTY STATEMENT ALSO DOES NOT LIMIT OR EXCLUDE SITUATIONS OR CLAIMS WHERE WEBER HAS MANDATORY LIABILITY AS PRESCRIBED BY STATUTE.

NO WARRANTIES SHALL APPLY AFTER THE APPLICABLE PERIODS OF THIS WARRANTY. NO OTHER WARRANTIES GIVEN BY ANY PERSON, INCLUDING A DEALER OR RETAILER, WITH RESPECT TO ANY PRODUCT (SUCH AS ANY "EXTENDED WARRANTIES"), SHALL BIND WEBER. THE EXCLUSIVE REMEDY OF THIS WARRANTY IS REPAIR OR REPLACEMENT OF THE PART OR PRODUCT.

IN NO EVENT UNDER THIS VOLUNTARY WARRANTY SHALL RECOVERY OF ANY KIND BE GREATER THAN THE AMOUNT OF THE PURCHASE PRICE OF THE WEBER PRODUCT SOLD.

YOU ASSUME THE RISK AND LIABILITY FOR LOSS, DAMAGE, OR INJURY TO YOU AND YOUR PROPERTY AND/OR TO OTHERS AND THEIR PROPERTY ARISING OUT OF THE MISUSE OR ABUSE OF THE PRODUCT OR FAILURE TO FOLLOW INSTRUCTIONS PROVIDED BY WEBER IN THE ACCOMPANYING OWNER'S MANUAL.

PARTS AND ACCESSORIES REPLACED UNDER THIS WARRANTY ARE WARRANTED ONLY FOR THE BALANCE OF THE ABOVE MENTIONED ORIGINAL WARRANTY PERIOD(S).

THIS WARRANTY APPLIES TO PRIVATE SINGLE FAMILY HOME OR APARTMENT USE ONLY AND DOES NOT APPLY TO WEBER BarbecueS USED IN COMMERCIAL, COMMUNAL OR MULTI-UNIT SETTINGS SUCH AS RESTAURANTS, HOTELS, RESORTS, OR RENTAL PROPERTIES.

WEBER MAY FROM TIME TO TIME CHANGE THE DESIGN OF ITS PRODUCTS. NOTHING CONTAINED IN THIS WARRANTY SHALL BE CONSTRUED AS OBLIGATING WEBER TO INCORPORATE SUCH DESIGN CHANGES INTO PREVIOUSLY MANUFACTURED PRODUCTS, NOR SHALL SUCH CHANGES BE CONSTRUED AS AN ADMISSION THAT PREVIOUS DESIGNS WERE DEFECTIVE.

Weber-Stephen Products (Aust) Pty Ltd.
Level 1, 142-144 Fullarton Road
ROSE PARK SA 5067 AUSTRALIA
+61 8 8221 6111

WEBER New Zealand ULC
86 East Highbrook Drive
East Tamaki, Auckland 2013 NEW ZEALAND
+64 9 279 7133

PRODUCT CARE

Cleaning and Maintenance

Cleaning the Inside of the Barbecue

Over time, the performance of your barbecue can diminish if it has not been maintained properly. Low temperatures, uneven heat, and food sticking to cooking grills are all signs that cleaning and maintenance are overdue.

A thorough cleaning is recommended when the barbecue is going to be stored, or at least twice a year. Consistent use may require quarterly cleanings. When your barbecue is off and cool, start by cleaning the inside, from the top down.

Cleaning the Lid

From time to time you may notice "paint-like" flakes on the inside of the lid. During use, grease and smoke vapors slowly change into carbon and deposit on the inside of your lid. These deposits will eventually peel, and looks very similar to paint. These deposits are non-toxic, but the flakes could fall onto your food if you do not clean the lid regularly.

- 1) Brush the carbonized grease from the inside of the lid with a stainless steel bristle barbecue brush (A). To minimize further build-up, the inside of the lid can be wiped with a paper towel after barbecuing while the barbecue is still warm (not hot).

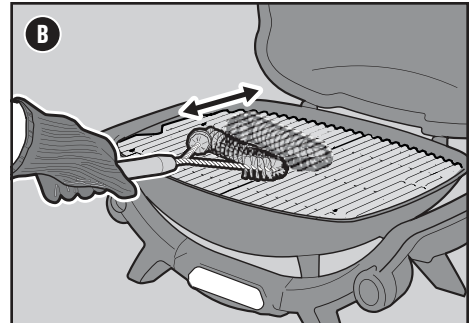
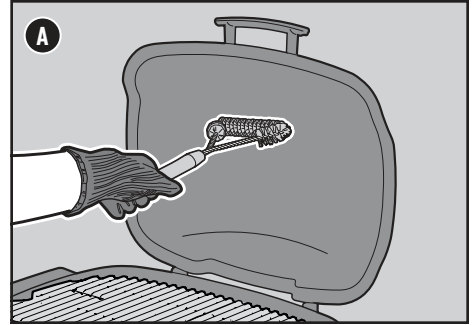

Cleaning the Cooking Grills

If you have been cleaning your cooking grills before every cook, as recommended, the debris on your grills should be minimal.

- 1) With grills installed, brush the debris off your cooking grills with a stainless steel bristle barbecue brush (B).

Cleaning the Burner

Two areas on the burner that are key to optimum performance are the ports (small openings running along the length of the burner) and the spider/insect screens on the ends of the burner. Keeping these areas clean is essential for safe operation.

Cleaning the Burner Ports

- 1) Take the cooking grills out and set aside.
- 2) Use a clean stainless steel bristle barbecue brush to clean the outside of the burners by brushing across the top of the burner ports (C). Do not brush lengthwise along the tube, as this will only brush debris from one port to another.
- 3) When cleaning the burner, avoid damaging the ignition electrode by carefully brushing around it.

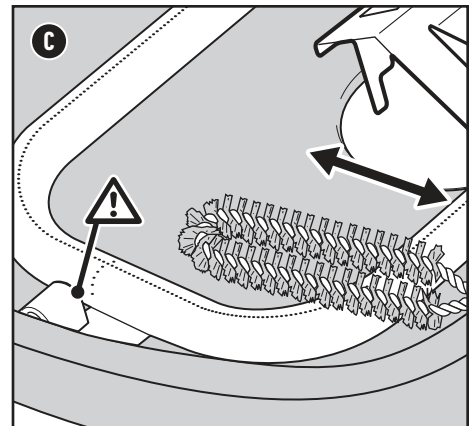

Cleaning the Spider Screens

- 1) Locate the end of the burner behind the control panel where it meets the valve.
- 2) Remove the screw from the top of the rain shield, then remove the rain shield from the burner tube (on select models only) (D).
- 3) Clean the spider/insect screen on the burner using a soft bristle brush (E).
- 4) Reinstall the rain shield over the end of the burner tube and secure with screw.

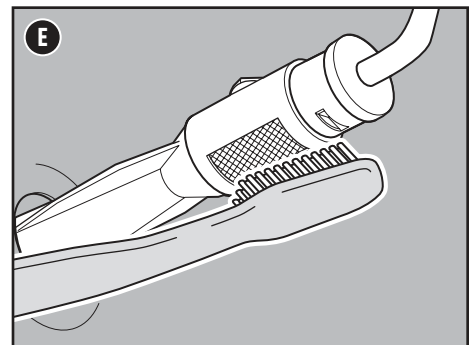
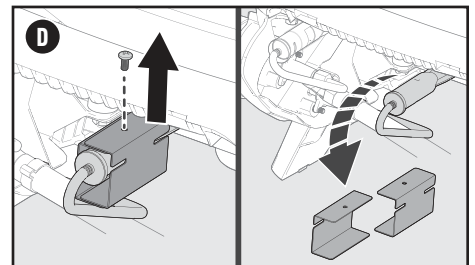

⚠ DANGER: Do not line the slide-out catch pan or cookbox with aluminum foil.

⚠ DANGER: Check the slide-out catch pan for grease build-up before each use. Remove excess grease to avoid a grease fire.

⚠ WARNING: Use caution when removing slide-out catch pan and disposing of hot grease.

⚠ WARNING: Use heat-resistant barbecue mitts or gloves when operating barbecue.

⚠ WARNING: Barbecue brushes should be checked for loose bristles and excessive wear on a regular basis. Replace brush if any loose bristles are found on cooking grills or brush. WEBER recommends purchasing a new stainless steel bristle barbecue brush at the beginning of every spring.

⚠ WARNING: Keep ventilation openings around cylinder clear and free of debris.



Cleaning the Cookbox

Look inside the cookbox for any grease accumulation or leftover food particles. Excessive accumulation can cause a fire.

- 1) Take the cooking grills out and set aside.
- 2) Use a plastic scraper to scrape debris off the sides and bottom of the barbecue into the opening in bottom of the cookbox (F). This opening leads debris into the slide-out catch pan.
- 3) Some models come with a heat deflector which sits in the bottom of the bowl. This can be cleaned using a plastic scraper or can be easily removed and washed with hot soapy water. After cleaning the heat deflector, make sure it is properly seated over the opening in the bottom of the cookbox.

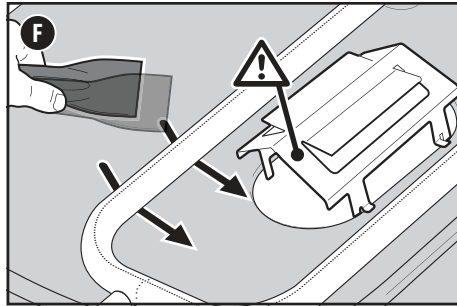

Cleaning the Grease Management System

The grease management system consists of a slide-out catch pan and a disposable drip tray (G). These components were designed to be easily removed, cleaned, and replaced; an essential step every time you prepare to barbecue.

Cleaning the Outside of the Barbecue

The outside of your barbecue may include stainless steel, painted aluminium, and plastic surfaces. WEBER recommends the following methods based on the surface type.

Cleaning Painted Aluminium Surfaces and Plastic Components

Clean painted aluminium and plastic components with warm soapy water, and paper towels or cloth. After wiping down the surfaces, rinse and dry thoroughly.

Cleaning the Outside of Barbecues that are in Unique Environments

If your barbecue is subject to a particularly harsh environment, you will want to clean the outside more often. Acid rain, pool chemicals, and salt water can cause surface rusting to appear. Wipe down the outside of your barbecue with warm soapy water. Follow up with a rinse and thorough drying.

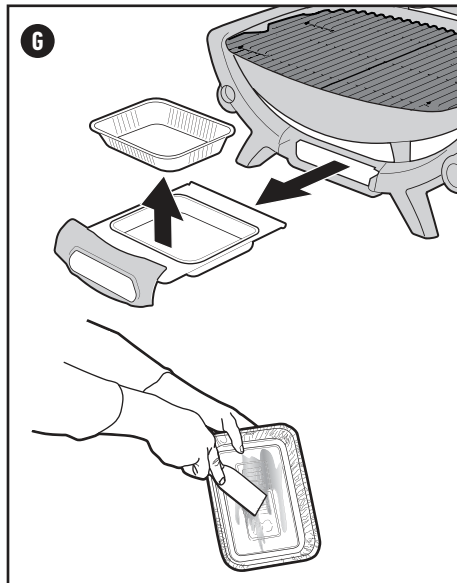

⚠ WARNING: Turn your barbecue off and wait for it to cool before thoroughly cleaning.

⚠ WARNING: When cleaning the burners, never use a brush that has already been used to clean the cooking grills. Never put sharp objects into the burner port holes.

⚠ CAUTION: Do not use any of the following to clean your barbecue: abrasive stainless steel polishes or paints, cleaners that contain acid, mineral spirits or xylene, oven cleaner, abrasive cleansers (kitchen cleansers), or abrasive cleaning pads.

Proper Burner Flame Pattern

The burner in your barbecue is factory set for the correct air and gas mixture. When the burner is performing correctly, you will see a specific flame pattern. The tips may occasionally flicker yellow (A), with a descending light blue (B) to dark blue flame (C).

⚠ WARNING: Blocked and dirty ports can restrict full gas flow, resulting in a fire (D) in and around the gas valves, causing serious damage to your barbecue.

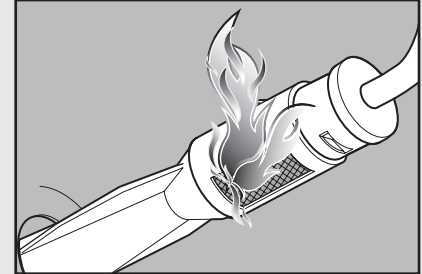
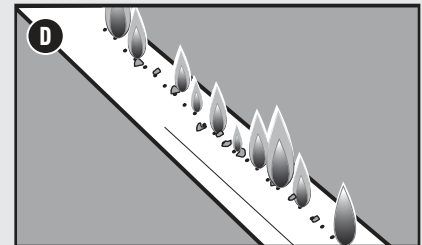
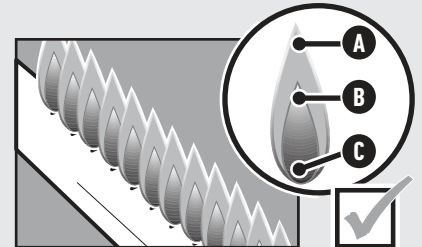

Spider Screens

The combustion air openings of the burners (E) are fitted with stainless steel screens to prevent spiders and other insects from spinning webs and building nests inside the burners. Additionally, dust and debris can accumulate on the outside of the spider/insect screen and obstruct the oxygen flow to the burners.

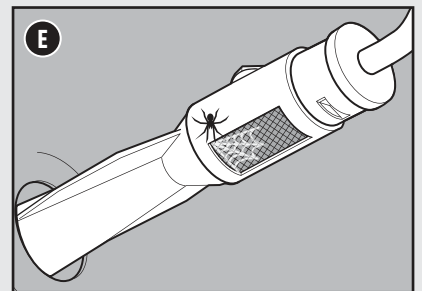

⚠ WARNING: Do not attempt to make any repair to gas carrying, gas burning, ignition components or structural components without contacting Weber-Stephen Products LLC, Customer Service Department.

⚠ CAUTION: The burner tube openings must be positioned properly over the valve orifices.

Inspect the Hose

Routine inspection of the hose is necessary.

- 1) Confirm that the barbecue is off and cool.
- 2) Check hose for any signs of cracking, abrasions, or cuts (H). If the hose is found to be damaged in any way, do not use the barbecue.

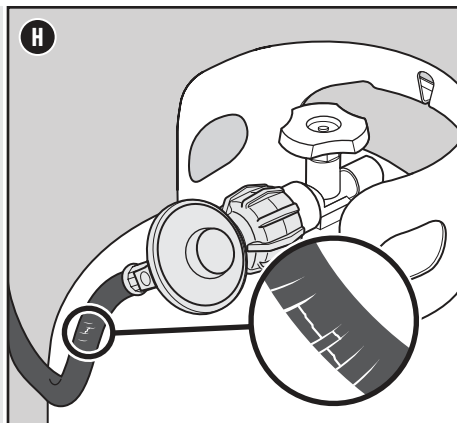

⚠ WARNING: If the hose is found to be damaged in any way, do not use the barbecue. Replace using only WEBER authorized replacement hose.



TROUBLESHOOTING

BARBECUE WILL NOT IGNITE

SYMPTOM

- Burner does not ignite when following the ignition instructions in the “Operation” section of this Owner’s Manual.

CAUSE	SOLUTION
There is a problem with gas flow.	If the barbecue will not ignite, the first step is to determine if there is gas flowing to the burners. To check this, follow the instructions below for “Using a Match to Determine if there is Gas Flow to the Burners.” If match lighting IS NOT successful , follow the instructions for disconnecting and reconnecting the LPG cylinder.
There is a problem with the ignition system.	If the barbecue will not ignite, the first step is to determine if there is gas flowing to the burners. To check this, follow the instructions below for “Using a Match to Determine if there is Gas Flow to the Burners.” If match lighting IS successful , check the condition of the battery (electronic ignition systems only) and check the wire connections of the Ignition System.

Using a Match to Determine if there is Gas Flow to the Burners

- 1) Open the barbecue lid.
- 2) Check that the burner control knob is in the off \bigcirc position. Check by pushing in and turning knobs clockwise.
- 3) Confirm that the cylinder is properly installed and gas is on. Refer to “Cylinder Installation.”
- 4) Strike a match and put the flame under the matchlight hole (A).
- 5) While holding lit match, push the main burner control knob in and turn it counterclockwise to the start/high ⚡ position.
- 6) Check that the burner is lit by looking through the cooking grills.
- 7) If the burner does not ignite within 5 seconds, turn burner control knob to the off \bigcirc position and wait five minutes to allow the gas to clear before attempting to light the burner again.
- 8) If the burner ignites, the problem lies in the ignition system. For piezo igniters, check the wire connections of the Ignition System (B). For electronic ignition systems, check the condition of the battery and check the wire connections of the Ignition System (C). Verify that the AAA battery (alkaline only) is in good condition and is installed correctly. Some batteries have a plastic protective wrap around them. This plastic must be removed before installing battery. Do not confuse this plastic with the battery label.

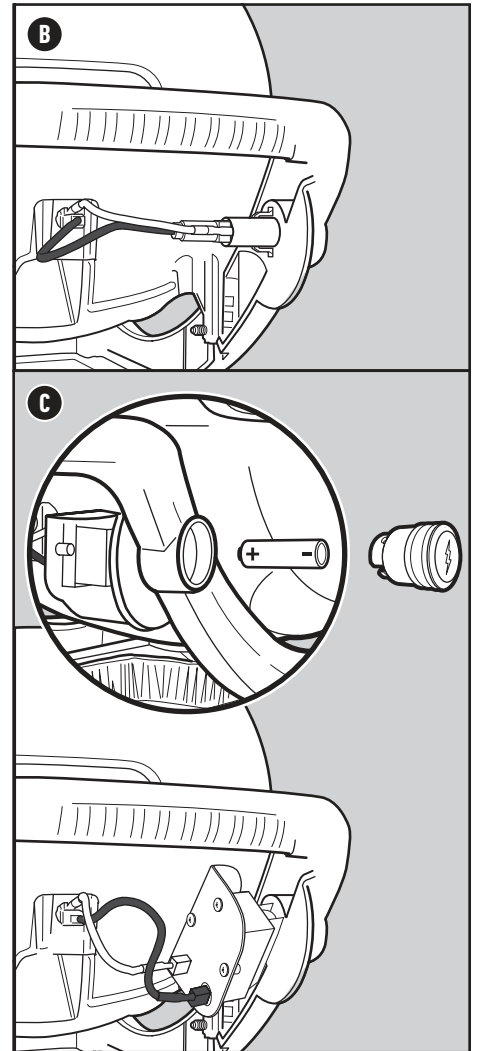
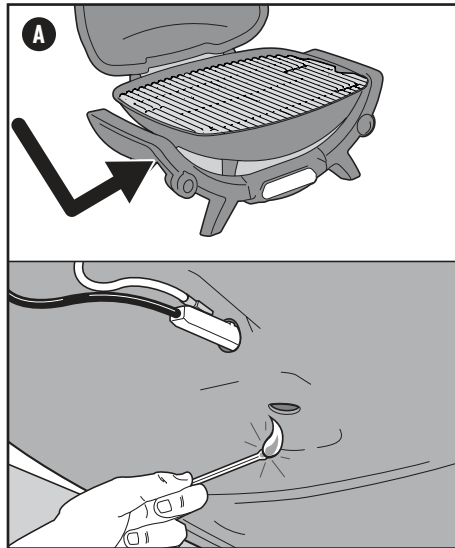

REPLACEMENT PARTS

To obtain replacement parts,
contact the local retailer
in your area or log onto weber.com.

Weber-Stephen Products (Aust) Pty Ltd.

Level 1, 142-144 Fullarton Road
ROSE PARK SA 5067 AUSTRALIA
+61 8 8425 9400 | weber.com/AU

WEBER New Zealand ULC

86 East Highbrook Drive
East Tamaki, Auckland 2013 NEW ZEALAND
+64 9 279 7133 | weber.com/NZ

CALL CUSTOMER SERVICE

If you are still experiencing any
problems, contact the Customer Service
Representative in your area using the
contact information on weber.com.