

3 YEAR WARRANTY



Scan the QR code using a smart-phone device, for product warranty registration online.

DIAMOND 12i Series

DIAMOND 12.0i

DIAMOND 12.1i

DIAMOND 12.2i

DIAMOND 12.3i

DIAMOND 12.4i

DIAMOND 12.Ci

DIAMOND 12 3Di SURROUND

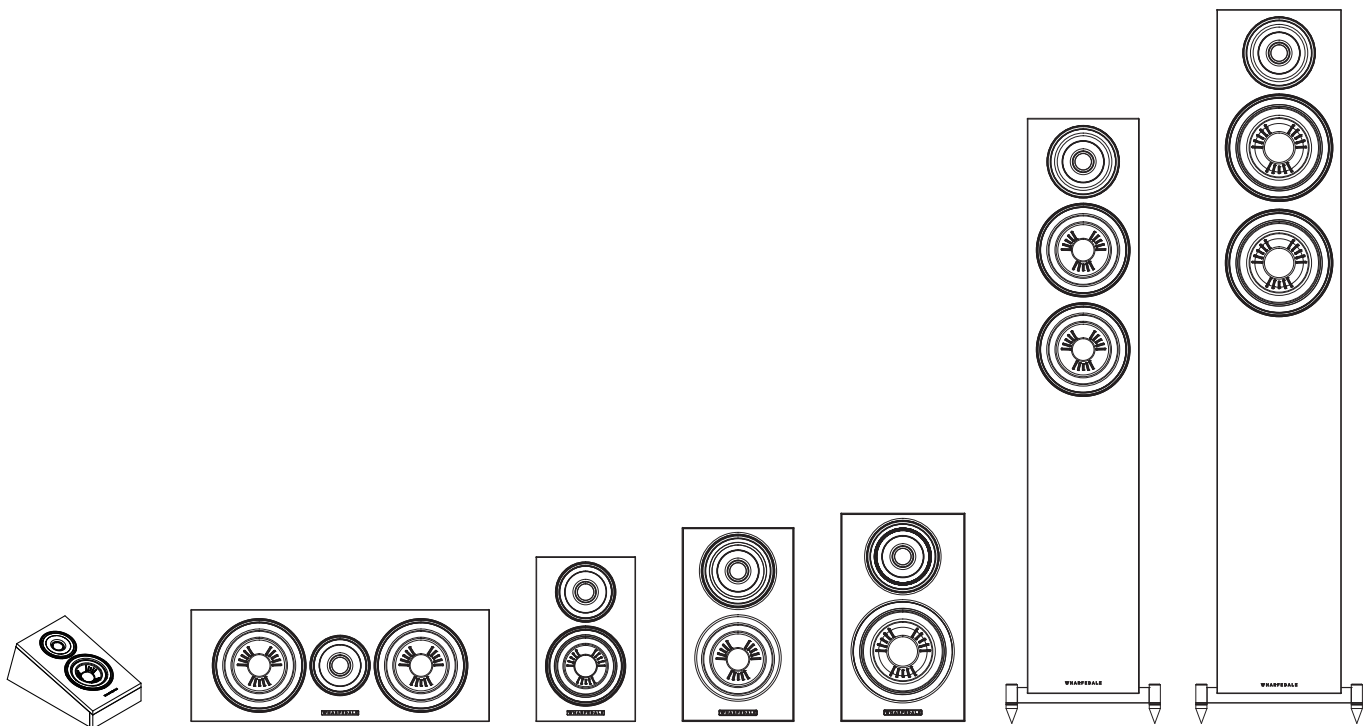

Important Safety Information

Before installing this product read all these instructions!



This symbol indicates that there are important operating and maintenance instructions in the literature accompanying this unit.

Read these instructions. Keep these instructions. Heed all warnings. Follow all instructions.

Before making any connections, switch all the units in your system off at the mains.

Set the volume control at minimum when you switch on your system or change sources, and turn the level up gradually.

DO NOT use your amplifier at full volume.

Ensure that all loudspeakers in the system are correctly wired.

DO NOT subject your loudspeakers to excessive cold, heat, humidity or sunlight.

Loudspeakers should not be placed directly facing other hi-fi units, or share the same shelf or cabinet.

DO NOT place heavy objects on top of loudspeakers.

Some manufacturers forbid the placing of objects on top of their TV sets. Check your TV handbook before installing the speaker directly on your TV set. Consult your TV dealer if you are in any doubt.

DO NOT connect speaker terminals to the mains supply.

DO NOT dismantle the loudspeaker. There are no user serviceable parts inside it and you will void the warranty by doing so.

Refer all servicing to qualified service personnel. Servicing is required when the apparatus has been damaged in any way, the apparatus has been exposed to rain or moisture, does not operate normally, or has been dropped.

Caution: Changes or modifications not expressly approved by the manufacturer could void the user's authority to operate this device.

Unpacking Your Loudspeaker

DIAMOND 12i loudspeakers come in different shapes and sizes. If you are unpacking a floor stander, please remember that these units are heavy. We suggest that you have someone to assist you.

Lift the loudspeaker carefully out of the packing. **DO NOT** try and lift the loudspeaker using the protective bag.

Unpack the accessories carefully.

If there is any sign of damage or if the contents are incomplete, report this to your dealer as soon as possible.

Retain the packing for future safe transport of the product. If you dispose of the packing, do so with respect to any recycling provisions in your area.

Attaching the Spikes to Floorstanding Models – D12.3i, D12.4i

- Make sure you have plenty of unobstructed working space.
- Place a soft cloth on the floor to protect the loudspeaker.
- Invert the loudspeaker onto the cloth.
- Thread a locknut onto each spike and loosely rub it up the thread.
- Thread the spikes into the spike inserts. Tighten them with finger tight.
- Invert the loudspeaker. Be careful not to damage the floor with the spikes.

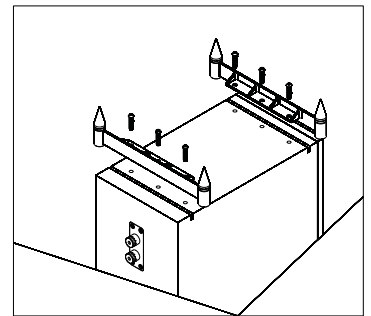

Levelling the Loudspeakers

When the speaker is upright: You will probably find that the speaker will wobble with one spike not contacting the floor. Adjust this spike until all four spikes are in contact to the floor.

With the aid of a spirit level move each spike in and out until the loudspeaker is level and sitting squarely on all four spikes without rocking.

Now tighten each locknut securely against the collar in the plinth to secure the spike.

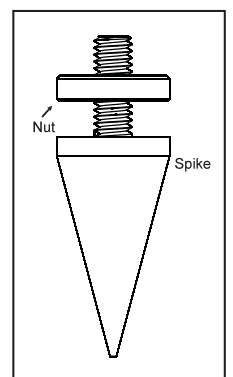

Preparing the DIAMOND 12i Loudspeakers

Stands and Brackets

The bookshelf loudspeakers are intended primarily for stand mounting, though they can be mounted on wall brackets or even on sturdy shelves. The quality of loudspeaker stands greatly influences the performance of your loudspeakers, please do not use flimsy products.

Centre Channel Loudspeakers

Each centre channel loudspeaker is supplied with one set of mounting feet. By using combination of large and small feet the loudspeaker may be angled to point directly at the listening position. This will be found useful when the centre speaker is positioned under the TV screen.

Cables and Connectors

Choosing Loudspeaker Cable

Specialist audio cable usually offers better performance than general purpose 'bell' or 'zip' wire.

Choose a cable of suitable diameter – cable that is too thin will limit the dynamics of the sound and may impair the bass response. Audio cable is polarised, with two cores of different colours, or often a raised rib or coloured tracer in the case of twin cable. Before you purchase your cable, give careful thought to the positioning of your loudspeakers.

Cable lengths to loudspeaker pairs should be the same for left and right channels in order to equalise the signal transmission. Allow some slack in your speaker cables so you can alter their position to best advantage.

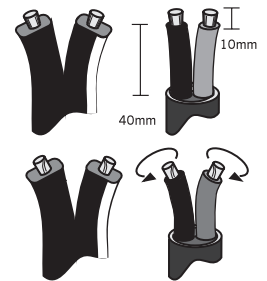

Preparing Loudspeaker Cable

Split the twin cores to a depth of about 40mm. Carefully strip the insulation from each end, leaving about 10mm of bare wire. If the cable is stranded, lightly twist to gather any loose strands.

Connecting Screw Terminals

All loudspeakers use screw terminals.

Unscrew the terminal. Insert the bare end of the cable into the hole in the base of the terminal. Tighten securely.

When connecting terminals make sure you leave no strands of bare wire that can short across to adjacent terminals.

As an alternative to bare wire you can use specialist spade connectors. Your Wharfedale dealer will be pleased to advise you on this issue.

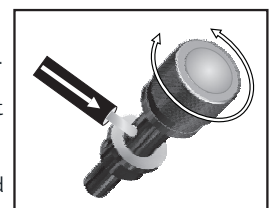

Positioning the Front Loudspeakers

The D12.3i and D12.4i models are designed to be floorstanding. We suggest that they are positioned at least 200mm from the rear walls and 700mm from the side walls, facing slightly inwards. The D12.0i, D12.1i and D12.2i models should be stand or wall mounted though they may be placed on a rigid shelf. The bass extension will improve if the small speakers are operated closer to the rear wall.

If the loudspeakers are placed too close to the walls the bass will increase but may be boomy and indistinct. If the loudspeakers are placed away from the walls, the inward angle may be increased by up to 40%, although this may restrict the width of the optimum listening position.

A useful rule of thumb is that the listener should be as far from the loudspeakers as they are from each other. The speakers should ideally be positioned so that the treble units are roughly at ear level to a seated listener. As personal taste plays a large role, experiment with different configurations and play a wide range of programmes before finalising the position of your speakers.

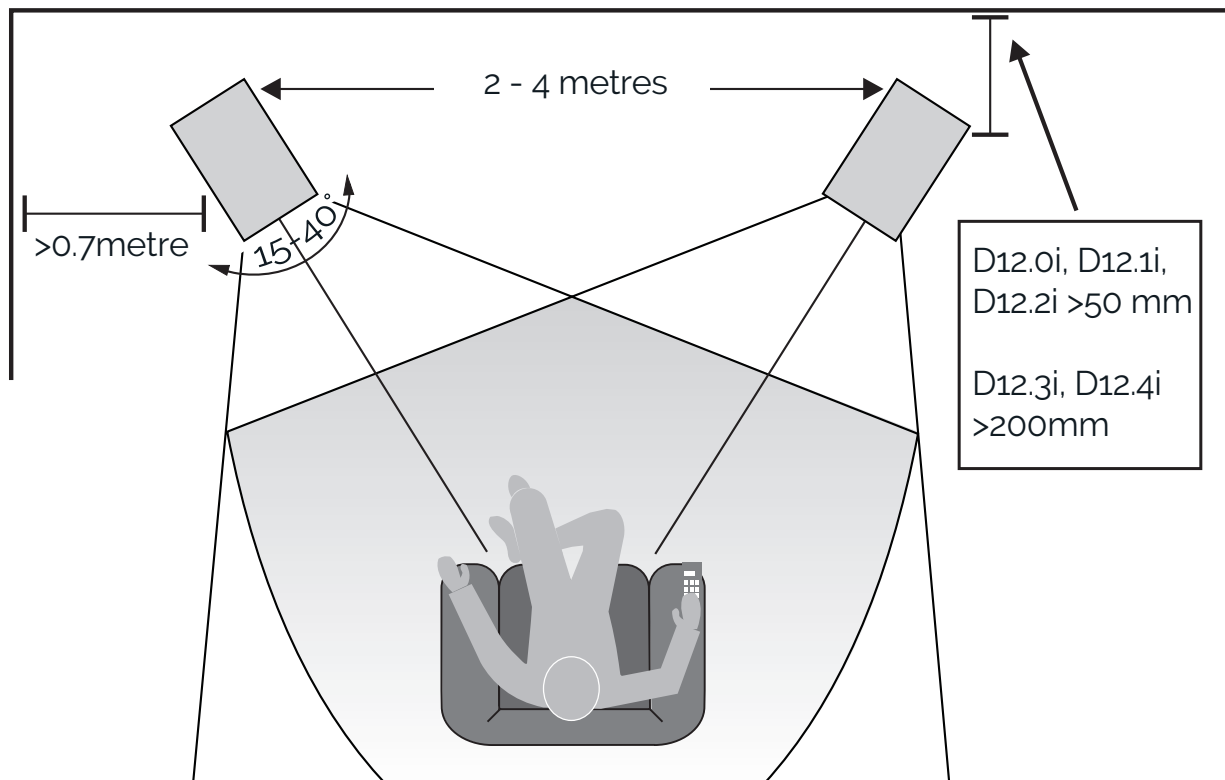

Positioning the Centre Loudspeaker

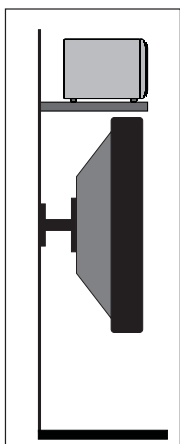

The centre channel loudspeaker should be positioned centrally between the loudspeakers, close to the television and mounted above or below the screen.

The loudspeaker should be located on a stable flat surface to avoid any cabinet movement at high sound levels. If you mount the unit above the television, move it forward so that the front grille sits slightly in front of the screen and the top of the cabinet.

A custom stand is available for the model which allows the loudspeaker to be positioned under a wall mounted monitor and has an adjustable vertical tilt for optimal dispersion.

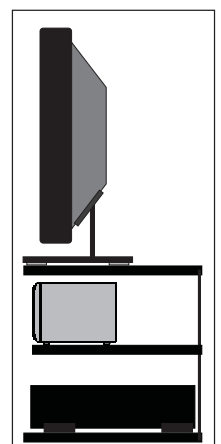

Connecting the Front Loudspeakers

Standard Connection

Choose a suitable length of twin core speaker cable for each channel, and prepare the ends. Unscrew each terminal a few turns. Connect the red, positive (+) terminal of the Left loudspeaker to the corresponding red, positive (+) amplifier terminal. Connect the black, negative (-) terminals similarly.

Tighten the terminals securely. Repeat this procedure for the Right channel.

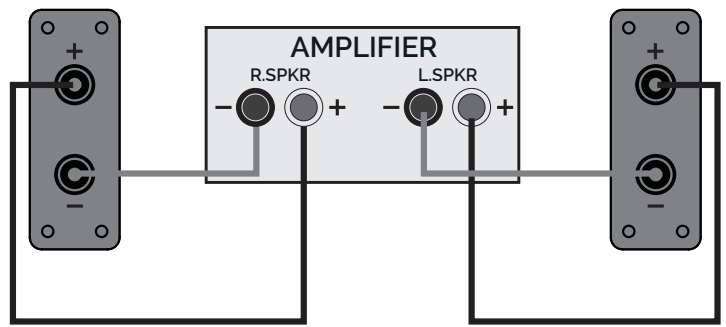

Connecting Centre Loudspeaker

The Centre channel speaker may be connected as shown.

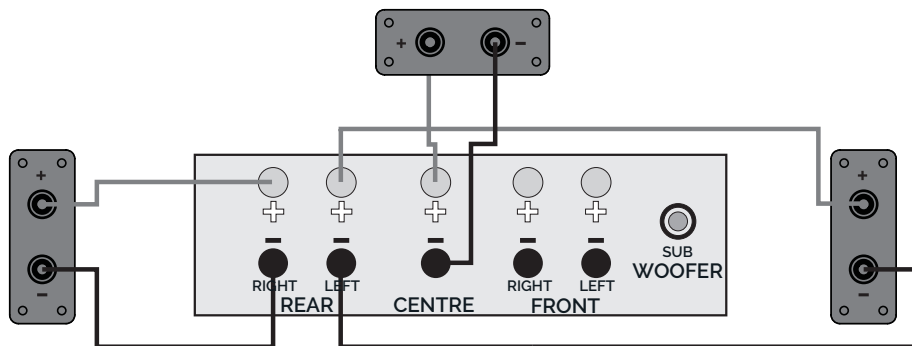

Setting Up a Home Theatre System

Placement

Front and Effects Channels: The front loudspeakers are placed on either side of the television screen, 2 to 3 metres apart. The speakers should be angled slightly so they are aimed towards the listeners.

We recommend placing the rear effects speakers in a high position, behind the listener's head. If the rear or side walls are a long way from the listening seat, consider stand mounting the loudspeakers. If the centre loudspeaker is very high or low, angle it towards the listener's ear level.

The front faces of the centre and surround loudspeakers should also be in line as far as possible.

Subwoofer: As the ear is unable to detect the direction from which deep bass originates, you have freedom to position the unit. Varying the distance from the wall alters the bass. Placing the subwoofer across a corner boosts the bass but may impair clarity. The performance of a home theatre system can be enhanced by using two subwoofers.

6.1 and 7.1 System Placement

Dolby Labs, DTS and THX offer 6.1 and 7.1 format. Although the precise configuration of these systems will depend on the capabilities of your processor and you should be guided by those instructions, we would make some observation.

For 6.1 and 7.1 formats the listening seat should not be too close to the rear wall.

Optimising the time delay so that information from all speakers arrives the listening seat coherently is critical of the benefits of these systems are to be fully realised.

Dolby Labs Recommended Placement for Multichannel Home Theater Systems.

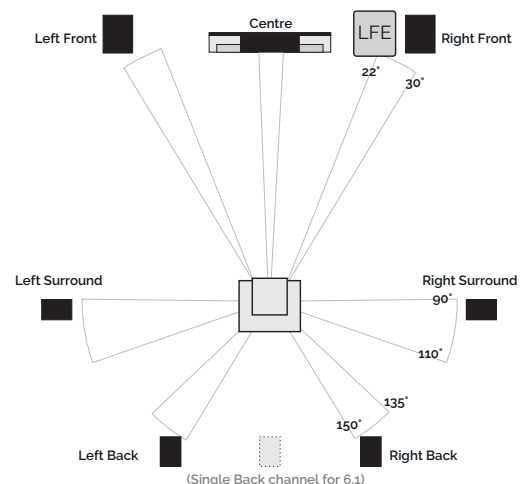

3Di and Height Channel Speaker Placement

The Diamond 12 3Di Surround is designed to offer elevation / height channel additions to your home theatre system in conjunction with AV receivers and processors which offer this performance capability.

The Diamond 12 3Di is designed for placement on top of any flat-top loudspeaker but optimised for the DIAMOND 12.3i and DIAMOND 12.4i. It can also be wall mounted.

The suggested positioning can be seen below:

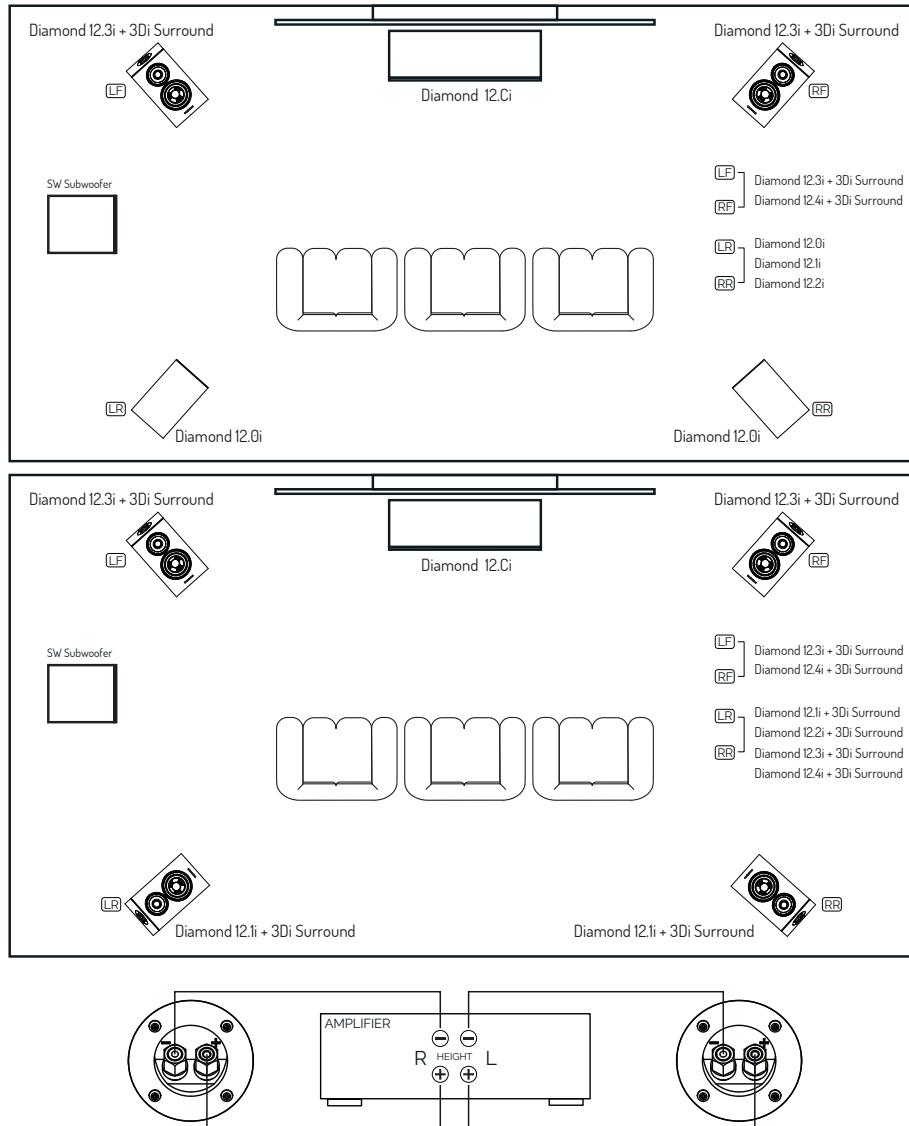

Wall mounting option:

Rubber feet (for mounting on flat surfaces or on top of floorstanding speakers such as Diamond 12.3i or Diamond 12.4i) and a wall bracket, with mounting screws (for wall fixing) are included with the Diamond 12 3Di.

For wall mounting, the bracket should be securely fixed into position with the included screws. The bracket can be used to hang the speaker on an appropriate and securely positioned wall fixing.

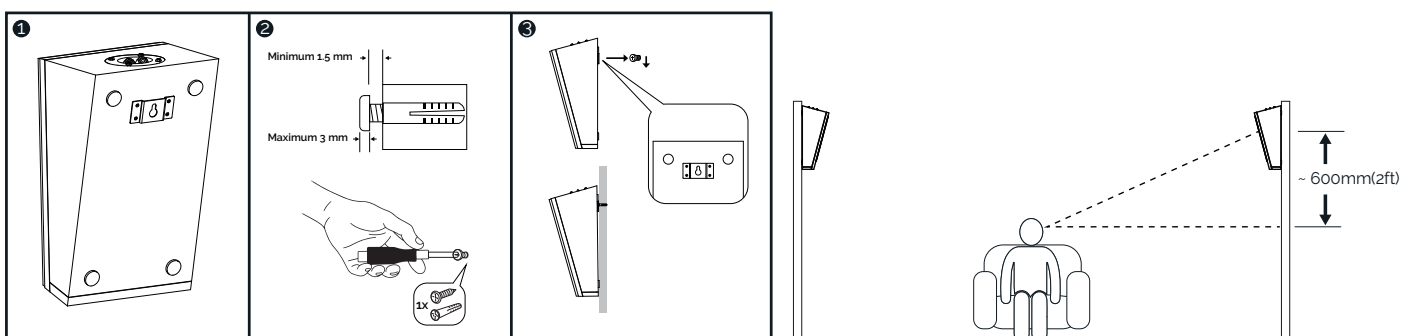

Setting Loudspeaker Sizes and Levels

If you are not using a subwoofer: Set the Front speakers to 'Large'. Set the 'Subwoofer' option on the processor to 'Off' or 'No'. The Front channels will now receive all the system bass.

If you are using a subwoofer: When set to 'Small' all the system bass will go into the subwoofer. If you choose 'Large' the Front channel bass will be reproduced from the Front speakers. Follow the instructions on this page for suitable size and crossover settings.

Once the loudspeaker settings have been finalised, put the A/V amplifier into its 'Test' mode (see instructions supplied with your processor). Adjust the level of each channel until all channels are reproduced at equal loudness.

On some programme material the surround channel may seem lower than the front. Do not readjust this level. You may, however, need to adjust the subwoofer output level. Avoid setting too high a level or you will swamp the sound with bass. This can be tiring to listen to, and may limit the subwoofer's ability to respond to large bass transients. You should also set a sensible level going into the subwoofer from the A/V processor. The subwoofer volume control should be between 12 o'clock and 3 o'clock.

Delay and LFE Settings

Many A/V processor feature delay settings. The purpose of delay is to enable surround and dialogue information to arrive at the listener's ears at the same time as the front channels, even when the listening seat is in a non-ideal position. On some processors, this can be achieved by setting the distance from the listening position to each speaker, but other systems allow only a time delay setting.

Rear Delay: If the listening position is equidistant from the front and rear speakers, set a low delay setting. The closer the listener is to the rear speakers this higher the delay setting used should be.

Centre Delay: If the centre speaker is level with (or slightly behind) the front speakers, set the delay to zero. If the centre speaker is forward of the front speakers, increase the delay.

LFE: In the cinema the low frequency effects channel is an extra bass channel with its own subwoofer. In domestic systems the LFE channel typically feeds into the subwoofer. Where no subwoofer is used, the LFE signal is combined with the front channels and sent to the front speakers. When you set the LFE level at your A/V processor, use care as powerful low frequencies can overload domestic loudspeakers. If you hear popping or thumping noises coming from the front loudspeakers or subwoofer, immediately turn the A/V processor's volume level down and then lower the LFE level. This should cure the problem. If it does not, lower the volume level at the subwoofer (if you are using one) until the problem disappears.

Phase: Please read the relevant sections of your A/V amplifier manual and familiarise yourself with the various issues. If you are unsure, consult your dealer for help. A home theatre system should have a precise front stage, a diffuse rear stage and good localization of dialogue. If the colours on the loudspeaker terminals do not correspond with those on the amplifier, the sound will appear poorly focused or 'out of phase'. For this reason it is essential that the speakers are connected according to the wiring diagrams in this manual.

Connecting loudspeakers correctly (in phase) is essential whether the system is stereo or multichannel.

Troubleshooting

Before investigating a problem, always switch off the system at mains.

If your system is not working properly please work through this checklist before returning the unit to your dealer.

Symptom	Possible Cause
No Sound	System not switched on; Speaker cables shorting terminals out; Wrong source selected
Sound lacks bass content	Subwoofer not switched on
Lack of bass reproduction	Subwoofer phase incorrect; Subwoofer crossover control too low
Excessive bass distortion at low volumes	Subwoofer set to high; LFE level set too high; Subwoofer incorrectly wired
Excessive or distorted bass at high levels	System level set too high; Bass control set too high; Subwoofer too close to room corners
Distorted / rattling sound at high levels	System level set too high; Objects too close to subwoofer
Popping or thumping from the subwoofer	System level set too high; Subwoofer level set too high; LFE level set too high

Looking After Your Loudspeaker

- Your loudspeakers use special hardwearing sealed finish. They should not be waxed or treated with spray polishes which will smear and dim the finish. Occasionally polish them with a dry or barely moist cloth to remove dust and finger marks, etc.
- If you play the speakers with the grilles off exercise great care. NEVER operate speakers with the grilles off if there are children or pets in the house.
- Occasionally, remove the loudspeaker grilles and brush them gently with a soft brush before replacing them carefully.
- We advise that you do not use a vacuum cleaner to clean loudspeaker grilles.
- We advise that you do not place anything on your loudspeakers to prevent damage to the cabinet surface.
- Avoid getting any liquid behind the grille. If you spill liquid on your loudspeakers, take them to your dealer for attention before using them again.
- DO NOT open the speakers, there are no user serviceable parts inside.
- NEVER touch the drive units either with an object or your hands.

Warranty Coverage

Your loudspeakers have been constructed to the highest standards. From top grade furniture construction and finish to carefully designed and selected acoustic components, Wharfedale speakers are built to provide a lifetime of sonic pleasure. We hope you will derive many years of good service from our products.

Wharfedale warrants its products, subject to the following terms and conditions below, to be free from defects in materials and workmanship.

Online Registration



Scan the QR code using a smart-phone device, for product warranty registration online.

- The three (3) year extended warranty is applicable to items purchased from Jan 1st 2021, onwards. Items purchased prior to this date are not eligible for this extended warranty service but are subject to statutory warranty claims and all applicable consumer rights.
- To qualify for the extended 3 year warranty, you must register your product within ninety (90) calendar days from the date of purchase. Visit wharfedale.co.uk/warranty-registration/ to complete your online registration. Items not registered online will have a Limited Warranty for one (1) year, or for the period of your country's statutory warranty, whichever is longer.
- Warranty can only be offered to products registered with proof of purchase with date, model and details of the authorised dealer clearly stated on the receipt/invoice. Please keep the original receipt/invoice in case it is required for a warranty claim.
- This Limited Warranty is non-transferable and is offered exclusively to the original owner.
- This Limited Warranty is valid only in the original country of purchase.
- Repairs or replacements are provided under this warranty are the exclusive remedy of the consumer. **Wharfedale** shall not be liable for any incidental or consequential damages for breach of any expenses or implied warranty with any product. Except to the extent prohibited by law, this warranty is exclusive and in lieu of all other warranties whatsoever, both expressed and implied, including but not limited to the warranty of merchantability and fitness for practical purpose.
- This warranty provides benefits that are additional to and do not affect your statutory consumer rights.
- This Limited Warranty offer is subject to correct information being submitted in your application. Incorrect dates or mismatched purchase receipt dates that are outside of the warranty terms will immediately invalidate any warranty claim.

**Please check with your dealer local distributor for further information.*

Exclusions

- The following items are excluded from the **Wharfedale** warranty:
 - Normal wear and tear and cosmetic damage (including but not limited to any wear from reasonable use, environmental deterioration or neglect)
 - Products on which the serial number has been removed, altered or otherwise made illegible.
 - Products not purchased from an authorised **Wharfedale** dealer.
 - Products that were not new at the time of original purchase.
 - Products sold 'as is', 'as seen' or 'with faults'.
 - Product not purchased from an Authorised Dealer/Distributor within the region of the claim (ie parallel imports or grey market products)
 - Accidental damage or faults caused by commercial use, acts of God, incorrect installation, incorrect connection, incorrect packaging, misuse or careless operation or handling which is not in accordance with the user instructions.
 - Equipment that has been operated in conjunction with unsuitable, inappropriate or faulty apparatus.
 - Repairs, alterations or modifications carried out by parties other than **Wharfedale** or its authorised service partners.

- Damage in transit that cannot be attributable to the fault of **Wharfedale**, the authorised distributor or dealer (ie. claims otherwise covered by transit insurance.)
 - Faults relating to abnormal or inappropriate power supply voltage or power surges.
 - Faults relating to extremities in temperature, exposure to heat, water or other liquids, insects, excessive moisture, sand, chemicals, battery leakage or any other contaminants.
 - Any force majeure events, including but not limited to any acts of God, fire, lightning, typhoon, storm, earthquake, hurricane, natural disaster, tsunami, flood, war, riot, public disturbance.
 - Any other causes beyond the reasonable control of either **Wharfedale** and its Authorised Distributor.
- Please note items purchased before 1st Jan 2021 are not eligible for the extended warranty claim.

How to Claim

- To obtain warranty service please contact the authorised dealer from which you purchased this product and present the limited warranty certificate offered upon registration of your product's extended warranty offer.
- Do not dispatch goods without the prior agreement of the dealer distributor or authorised service centre.
- If asked to return products for inspection and or repair, please pack carefully preferably in the original carton or packaging affording an equal degree of protection and returned via insured, trackable courier service.
- The authorised dealer or distributor will offer full return details and instructions. However, please note if unsuitable packaging is used the warranty may be deemed void due to improper action in return.
- **Wharfedale** or the authorised distributor, dealer or service centre may make a charge for the supply of new packaging for the return of the repaired item. Please note, Insurance is recommended as goods are returned at the owner's risk. Authorised distributors or service centres cannot be held liable for loss or damage in transit. Insurance and freight charges on the return journey will be paid for by **Wharfedale**, authorised dealer, distributor or service centre if corrective work proves to be necessary.
- In the event of 'no-fault found' or 'no repair necessary', the return shipping charge will be the responsibility of the owner.

Repairs

- All repairs will be carried out by the appointed distributor (or locally appointed service centre). Repairs handled or processed without authorisation or approval of the appointed representative will be excluded from this limited warranty. Please note, **Wharfedale** is not able to supply parts or replacement items to any other entity than the official distributor or authorised service centre.
- Other than the warranty and services set out in this warranty, to the fullest extent permitted by law, **Wharfedale** shall not be liable to you and/or any third party or entity whatsoever for:
 - Any loss, damages and/or malfunction caused to any product(s) which is/are connected to any of the products covered by this warranty.
 - Any damages, loss and liability, whether direct, indirect, incidental, consequential special, punitive or otherwise, howsoever caused by, arising out of or otherwise, in relation to the installation, delivery, use, service, repair, replacement and/or maintenance of the product.
 - Any damages, loss and liability under this warranty in respect of any act, omission, or negligence of any of their technicians, employees, agents, representatives or independent contractors relating to the actual or purported performance of any of the obligations under this warranty.

Service Centre Address

- For technical support, servicing or product queries and information please contact either your local retailer or the office below.
- IAG Service Dept., 13/14 Glebe Road, Huntingdon, Cambridgeshire, PE29 7DL, UK.
Tel: +44(0)1480 452561
Email: service@wharfedale.co.uk

For information on other authorised service centres worldwide contact **Wharfedale** International, UK.

- A world-wide distributors list is available on the **Wharfedale** website: www.wharfedale.co.uk

Specifications



Model	DIAMOND 12.0i	DIAMOND 12.1i	DIAMOND 12.2i
General Description	2-way bookshelf speaker	2-way bookshelf speaker	2-way bookshelf speaker
Design Philosophy and Core Technology			
Enclosure Type	bass reflex	bass reflex	bass reflex
Transducer Complement	2-way	2-way	2-way
ABR			
Bass Driver	4" (100mm) advanced PP Cone	5" (130mm) advanced PP Cone	6.5" (150mm) advanced PP Cone
Midrange Driver			
Treble Driver	1" (25mm) Textile Dome	1" (25mm) Textile Dome	1" (25mm) Textile Dome
Full-range Driver			
AV Shield	No	No	No
Sensitivity (2.83V @ 1m)	87dB	88dB	88dB
Recommended Amplifier Power	20-60W	20-100W	20-120W
Peak Power Handling			
Peak SPL	95dB	96dB	96dB
Nominal Impedance	8Ω Compatible	8Ω Compatible	8Ω Compatible
Minimum Impedance	4.0Ω	4.0Ω	4.0Ω
Frequency Response (+/-3dB)	70Hz - 20kHz	65Hz - 20kHz	50Hz - 20kHz
Bass Extension (-6dB)	65Hz	60Hz	43Hz
Crossover Frequency	2.7kHz	2.6kHz	2.0kHz
Cabinet Volume (in litres)	4.4L	8.2L	11.8L
Dimensions (H x W x D)	265 x 160 x (200+28) mm	312 x 180mm x (250+28) mm	335 x 200 x (285+28) mm
Net Weight	5.1kg/pcs	6.8kg/pcs	8.2kg/pcs

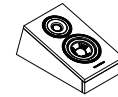
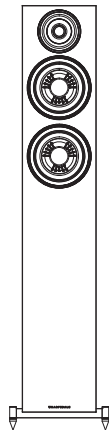
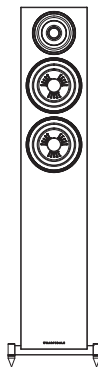

Model	DIAMOND 12.3i	DIAMOND 12.4i	DIAMOND 12.Ci	DIAMOND 12 3Di SURROUND
General Description	2.5-way floorstanding speaker	2.5-way floorstanding speaker	2-way centre speaker	2-way atmos speaker
Design Philosophy and Core Technology				
Enclosure Type	bass reflex	bass reflex	closed-box system	closed-box system
Transducer Complement			2-way	2-way
ABR				
Bass Driver	5" (130mm) advanced PP Cone	6.5" (150mm) advanced PP Cone	5" (130mm) advanced PP Cone x2	4" (100mm) advanced PP Cone
Midrange Driver	5" (130mm) advanced PP Cone	6.5" (150mm) advanced PP Cone		
Treble Driver	1" (25mm) Textile Dome	1" (25mm) Textile Dome	1" (25mm) Textile Dome	1" (25mm) Textile Dome
Full-range Driver				
AV Shield	No	No	No	No
Sensitivity (2.83V @ 1m)	89dB	89dB	90dB	82dB
Recommended Amplifier Power	30-150W	30-200W	20-120W	20-100W
Peak Power Handling				
Peak SPL	102dB	102dB	96dB	95dB
Nominal Impedance	8Ω Compatible	8Ω Compatible	8Ω Compatible	8Ω Compatible
Minimum Impedance	5.0Ω	5.0Ω	4.0Ω	4.3Ω
Frequency Response (+/-3dB)	45Hz - 20kHz	40Hz - 20kHz	90Hz - 20kHz	110Hz - 20kHz
Bass Extension (-6dB)	40Hz	35Hz	80Hz	90Hz
Crossover Frequency	2.2kHz	2.1kHz	2.2kHz	3kHz
Cabinet Volume (in litres)	26.6L	40.8L	8.7L	2.7L
Dimensions (H x W x D)	(925+50) x 180 x (320+28) mm	(1100+50) x 200 x (350+28) mm	180 x 480 x (180+28) mm	145 x 180 x 310 mm
Net Weight	19.5kg/pcs	22.4kg/pcs	8.5kg/pcs	3.2kg/pcs

