

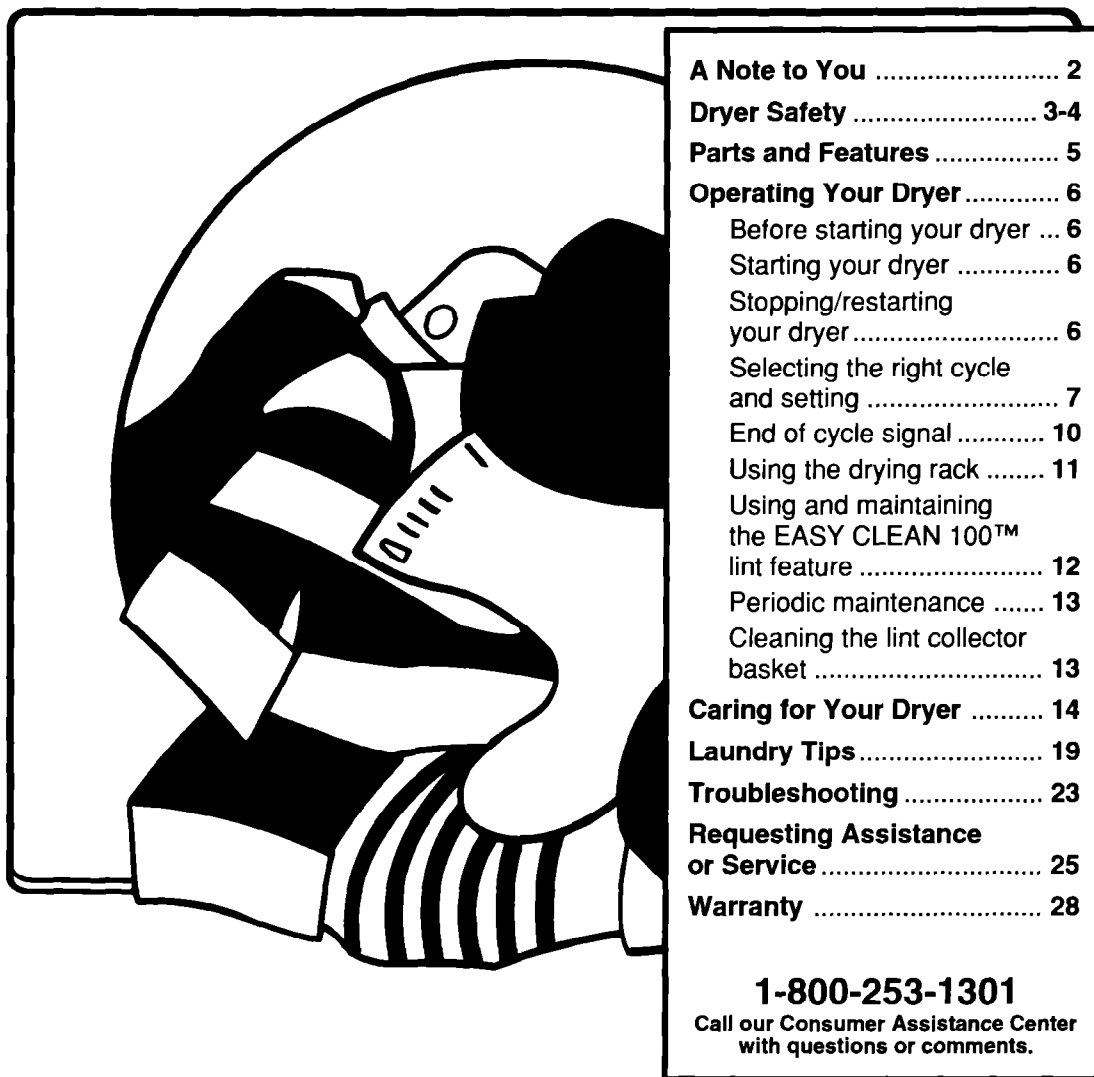

HOW TO MAKE A HOME RUN.™

Use And Care

G U I D E



EASY CLEAN 100™ ELECTRIC AND GAS DRYERS

PART NO. 3401091 Rev. A

2196 (D-Line)

A Note to You

Thank you for buying a WHIRLPOOL® appliance.

Because your life is getting busier and more complicated, WHIRLPOOL dryers are easy to use, save time, and help you manage your home better. To ensure that you enjoy years of trouble-free operation, we developed this Use and Care Guide. It contains valuable information about how to operate and maintain your dryer properly and safely. Please read it carefully. Also, please complete and mail in the Ownership Registration Card provided with your appliance. The card helps us notify you about any new information on your appliance.

Please record your model's information.

Whenever you call to request service on your appliance, you need to know your complete model number and serial number. You can find this information on the model and serial number label in the door well (see diagram on page 5 for location of label).

Please also record the purchase date of your appliance and your dealer's name, address, and telephone number.

Model Number _____

Serial Number _____

Purchase Date _____

Dealer Name _____

Dealer Address _____

Dealer Phone _____

Keep this book and the sales slip together in a safe place for future reference.

**Our Consumer Assistance Center
number is toll-free 24 hours a day.**

1-800-253-1301

Dryer Safety

Your safety is important to us.

This guide contains safety statements under warning symbols. Please pay special attention to these symbols and follow any instructions given. Here is a brief explanation of the use of the symbol.

WARNING

This symbol will help alert you to such dangers as death, fire, electrical shock, burns, and personal injury.

IMPORTANT SAFETY INSTRUCTIONS

WARNING

For your safety, the information in this manual must be followed to minimize the risk of fire or explosion, or to prevent property damage, personal injury, or loss of life.

– Do not store or use gasoline or other flammable vapors and liquids in the vicinity of this or any other appliance.

– **WHAT TO DO IF YOU SMELL GAS:**

- Do not try to light any appliance.
- Do not touch any electrical switch; do not use any phone in your building.
- Clear the room, building, or area of all occupants.
- Immediately call your gas supplier from a neighbor's phone. Follow the gas supplier's instructions.
- If you cannot reach your gas supplier, call the fire department.

Installation and service must be performed by a qualified installer, service agency, or the gas supplier.

continued on next page

Important Safety Instructions

⚠️ WARNING

To reduce the risk of fire, electrical shock, or injury to persons when using your dryer, follow basic precautions, including the following:

- Read all instructions before using your dryer.
- Dryer must be electrically grounded. See the Installation Instructions.
- Do not machine wash or machine dry items cleaned, washed, soaked in, or spotted with wax, paint, gasoline, oil, dry cleaning solvents, or other flammable fluids. The fumes can create a fire hazard or explosion. Always hand wash and line dry items containing these materials.
- Do not wash or dry items that are soiled with vegetable or cooking oil. These items may contain some oil after laundering. Due to the remaining oil, the fabric may smoke or catch fire by itself.
- Store flammable solvents or fluids away from your dryer.
- Dry cleaning solvents or fluids should never be put directly into your dryer.
- Do not let dust, lint, paper, rags, chemicals, etc., pile up around or under the dryer.
- Insert the transport tube into lint tray before closing dryer top (see page 17).
- Do not reach into a dryer if the drum is moving.
- Do not allow lint to build up inside the dryer or exhaust system (other than in the EASY CLEAN 100™ lint collector basket). Cleaning inside the dryer cabinet should be done periodically by a qualified person.
- Check status of lint collector basket window before each load.
- Empty lint collector basket when lint indicator window shows "Full".
- Do not allow children to operate, play with, or crawl inside your dryer. Supervise children when your dryer is used near children.
- Install and/or store dryer where it will not be exposed to the weather.
- Do not tamper with the controls.
- Do not dry rubber, rubber-like, or heat-sensitive materials with heat.
- Unplug the power supply cord or turn off electrical power before attempting to service your dryer. Also, shut off gas valve if you have a gas dryer.
- When removing from service or discarding a dryer, always remove the door to prevent accidental entrapment.
- Use only fabric softeners specifically labeled as not being harmful to the dryer.

Understanding your responsibilities

- Be sure that your dryer:
 - is located in an area where the temperature is above 45°F (7°C).
 - is properly installed in a well-ventilated room and leveled on a floor that can support the weight.*
 - is connected to the proper outlet and electrical supply.*
 - is properly connected to fuel and exhaust systems (gas dryers must be vented outdoors).*
 - is not installed against draperies or curtains, or on carpet.*
 - is properly maintained, repaired, and has parts replaced by a qualified person.
 - is used only for jobs normally expected of home clothes dryers.
 - is not used by anyone unable to operate it properly.
 - Never operate the dryer if:
 - it is not working right (i.e. squeaking or rubbing noises, too hot).
 - it is damaged.
 - parts are missing.s
 - all panels are not in place.
 - the lint collector basket is not properly inserted, damaged, blocked, or missing.
- * See the Installation Instructions for complete information.

Parts and Features

The parts and features of your dryer are illustrated below. Become familiar with all parts and features before using your dryer. Page references are included next to some features. Refer to those pages for more information about the features.

NOTE: The drawings in this book may vary from your dryer model. They are designed to show the different features of all models covered by this book. Your model may not include all features.

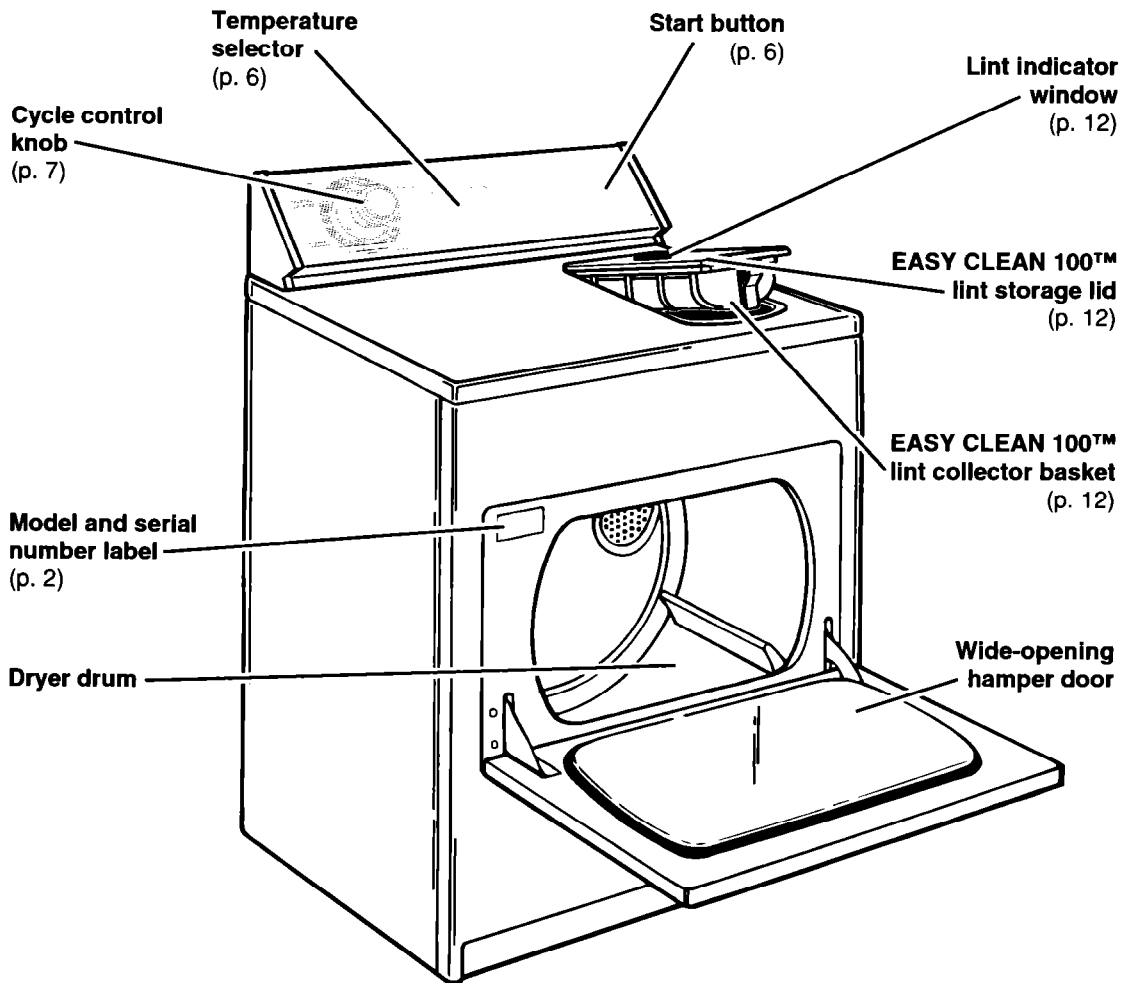

Additional features:
(on some models)

FINISH GUARD® option (p. 8)

End of cycle signal (p. 10)

Drying rack (p. 11)

Drum light (p. 14)

Operating Your Dryer

The information in this section helps you use your dryer efficiently and safely. Refer to "Laundry Tips" on page 19 for information on sorting, loading, and drying most types of washables.

Before starting your dryer

Before using your dryer, wipe the dryer drum with a damp cloth to remove dust from storing and shipping.



Your dryer may have a Dryer Features Guide (usually located on top of the dryer). Remove it and place it with your Use and Care Guide. The Features Guide provides you with more information about your dryer.



Starting your dryer

1. Load clothes into the dryer and close the door.



2. Make sure lint collector basket lid is securely closed, and that lint indicator window is not full. (See "Using and maintaining the EASY CLEAN 100™ lint feature" on page 12.)



3. Turn the Cycle Control Knob to the desired cycle. Use the Energy Preferred Automatic Setting (*) to dry most loads (see page 7).



4. Set the Temperature Selector to the desired setting. Refer to drying cycles charts on pages 9 and 10.

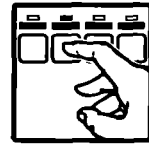

5. Push the Start Button.

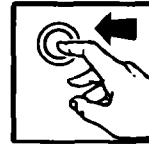

NOTES:

- Your dryer stops automatically when a cycle ends.
- Higher air flow from your new dryer may blow out accumulated lint from the existing exhaust system.

Stopping/restarting your dryer

You can stop your dryer anytime during a cycle.

To stop the dryer, either:

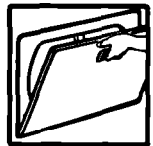

- Open the dryer door.

OR

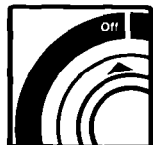

- Turn the Cycle Control Knob to Off.

NOTE: The Cycle Control Knob should point to an Off area when the dryer is not in use.

To restart the dryer:

1. Close the door.
2. Select a new cycle and temperature (if desired).
3. Push the Start Button.



Selecting the right cycle and setting

The following pages describe the cycles on your dryer. Refer to the charts on pages 9 and 10 for help in selecting drying cycles.

Drying guidelines

- Always follow care label directions when they are available.
- Use the Fluff Air cycle, or line dry rubber, plastic, delicate, and heat-sensitive fabrics (see page 10).
- The last few minutes of all cycles are without heat to make the load cooler to handle.
- To help reduce wrinkling, remove the load from the dryer as soon as tumbling stops. This is especially important for permanent press, knits, and synthetic fabrics.
- Overdrying can cause shrinkage, static cling, and damage to some fabrics.
- Check the EASY CLEAN 100™ lint indicator window. If full, refer to page 12 for cleaning.
- Refer to pages 19-22 for information about:
 - sorting clothes for drying
 - choosing load sizes
 - drying tips
 - using dryer fabric softeners
 - saving energy
 - drying special-care items.

Cycle descriptions

Electronic DRY-MISER® (Automatic) Cycle

Dry most loads using the Energy Preferred Automatic

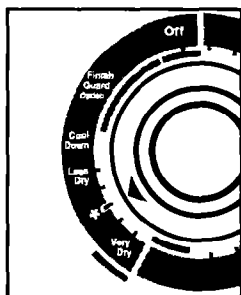

Setting (+). Your Automatic cycle(s) shuts off when the selected dryness is reached. The Cycle Control Knob may not move until the load is almost dry. After the cool-down, the Knob

continues to slowly turn to an Off area and tumbling stops, unless FINISH GUARD® is running (see page 8).

- If the load is drier than you like, select a setting closer to Less Dry the next time you dry a similar load.
- If the load is not as dry as you like, complete drying using a Timed cycle. Select a setting closer to Very Dry the next time you dry a similar load.

Some models offer high heat and low heat Automatic cycles (see page 9).

NOTES:

- Some Automatic cycles use an **electronic DRY-MISER®** control that senses the amount of moisture in the load.
- Other Automatic cycles use an **automatic DRY-MISER** control that senses the exhaust temperature and determines the dryness of the load.

Towels Feature (on some models)

When you have large loads of towels to dry,

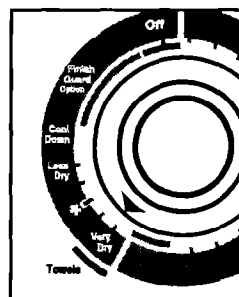

you may want to use the Towels feature in the Automatic Cycle. The Towels setting allows for more drying time and automatically shuts off the dryer when the selected dryness is reached.

The Towels feature also can be used for extra heavy items such as mattress pads and quilts.

continued on next page

OPERATING YOUR DRYER

FINISH GUARD® Option (on some models)

When you are unable to remove a load from the dryer as soon as it stops, wrinkles can form. The FINISH GUARD option tumbles the load without heat every few minutes up to 45 minutes after the cycle ends. This tumbling rearranges and fluffs the load to avoid wrinkles.

On some models you can turn the FINISH GUARD option On or Off. You do not have to set the Cycle Control Knob for the FINISH GUARD option. If you do not open the dryer door within a few minutes after the cycle stops, the FINISH GUARD option takes over to protect the load.

A signal sounds every few minutes when FINISH GUARD is running. The signal and cycle stop when you open the dryer door.

Timed Drying Cycle

Use the Timed Drying cycle to complete drying if some items are damp after Automatic drying. Timed drying is also useful for:

- Delicate items and small loads that need a short drying time.
- Bulky items and large loads that require a long drying time.

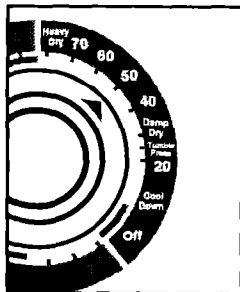

Heavy Dry Feature (on some models)

Use Heavy Dry and a high heat setting to dry large items or items that are thicker or heavier than a regular load (such as heavy cotton bath sheets or robes).

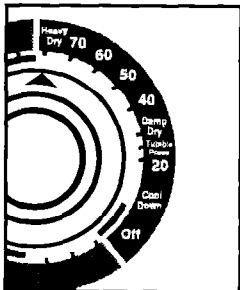

Damp Dry Feature

Use Damp Dry to dry items to damp level or to dry items that do not require an entire drying cycle. Two examples are heavy cottons, such as jeans, which you do not want to become stiff, or cotton clothes which are easier to press when damp.

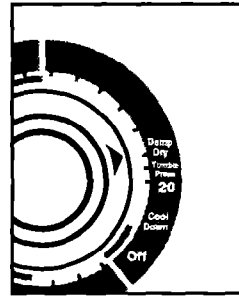

TUMBLE PRESS® Feature

The TUMBLE PRESS feature removes wrinkles from clothes that have been packed in a suitcase or closet, or from items not removed from the dryer at the end of a cycle. As soon as the dryer stops, fold or put the items on hangers.

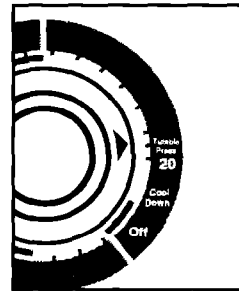

Fluff Air Cycle

The Fluff Air cycle has no heat. Use this unheated cycle to fluff or air dry bedding, plastic tablecloths, foam pillows, sneakers, etc. See page 10 for more information about the Fluff Air cycle.

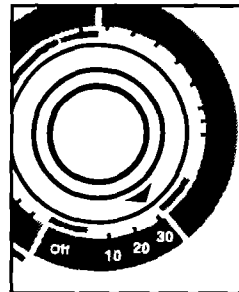

Drying cycles chart

Use the chart below to help you make drying selections. The chart suggests heat settings and drying times for various loads.

NOTES:

- Use an Automatic cycle to dry most loads.
- Use a Timed cycle if the recommended Automatic cycle is not available.
- The check mark ✓ in the chart below denotes recommended temperature settings. If some types of loads in the chart have more than one suggested temperature setting, choose the lowest setting available on your dryer.
- Always follow care label directions when they are available.

TYPE OF LOAD	AUTOMATIC CYCLE (heat settings)				TIMED DRYING CYCLE (minutes)	
	High	Medium*	Low	Extra Low*	High	Low
COTTONS AND LINENS Extra Heavy Bedspreads, mattress pads, quilts Heavyweight Towels, jeans, corduroys, work clothes Mediumweight Sheets, cotton underwear, diapers Lightweight Batistes, organdies, lingerie	✓ ✓	 ✓	 ✓	 	70-80 50-60 40-50	 20-30
PERMANENT PRESS, SYNTHETICS, AND BLENDS Heavyweight Work clothes, jackets, raincoats Mediumweight Shirts, play clothes, sheets, slacks Lightweight Lingerie, blouses, dresses	✓ 	 ✓	 ✓	 	40-50 30-40	 20-30
KNITS Heavyweight Cottons, rayons, blends, T-shirts, slacks, shirts Mediumweight Synthetics (polyester, acrylic, etc.), dress slacks, skirts, sweaters Lightweight Synthetics (polyester, acrylic, etc.) and blends, lingerie, blouses, dresses	✓ 	 ✓	 	 ✓	40-50 	 30-40 20-30

* Settings available only on dryer models with separate temperature selector.

OPERATING YOUR DRYER

Fluff Air cycle or line drying

The chart below includes examples of items that require drying without heat. Use the Fluff Air cycle, or place the items on a line or rack to air dry.

NOTES:

- Heat-sensitive fabrics should not be dried in the dryer.
- Line dry bonded or laminated fabrics.
- Always follow care label directions when they are available.

! WARNING



Fire Hazard

Use Fluff Air Cycle to dry items listed below.

Do not use heat to dry these items. Failure to do so can result in death or fire.

TYPE OF LOAD	FLUFF AIR CYCLE* (minutes)
DELICATE FABRICS Sheer curtains (two or three panels), gauze, lace, etc.	20-30
RUBBER, PLASTIC, HEAT-SENSITIVE FABRICS Foam Rubber – Pillows, padded bras, stuffed toys <ul style="list-style-type: none"> • Make sure coverings are securely stitched. • Shake and fluff pillows by hand several times during the Fluff Air cycle. • Make sure pillows are completely dry. Foam rubber pillows take a long time to dry. Plastic – Shower curtains, tablecloths Rubber-backed rugs Olefin, Polypropylene, Sheer nylon	20-30 20-30 40-50 10-20
COTTON AND CANVAS SHOES <ul style="list-style-type: none"> • Place several bath towels in the dryer to act as a buffer, or place shoes on a drying rack if your dryer has one. • Remove shoes from dryer while still damp. • Stretch shoes and allow to air dry. 	30-40

* Reset cycle as needed to complete drying.

End of cycle signal



The dryer sounds a signal to let you know when the cycle is finished. The signal is helpful when you are drying permanent press, synthetics, and other items that should be removed from the dryer as soon as it stops.

The end of cycle signal can be turned On or Off on some models.

Using the drying rack

(available as an option on some models)

To order the drying rack (Part #692990), call: **1-800-253-1301**. You will hear a recording. Follow the steps to place an order.

The drying rack lets you dry items that you may not want to tumble. The rack does not move, but the drum turns.

1. Fit rear legs of the rack into indentations in the back wall of the dryer. Lower the front so the legs rest on the dryer opening.

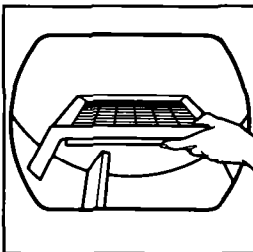

2. Put wet items on top of the rack. Leave space between the items so air can reach all surfaces.

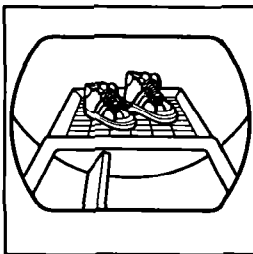

NOTE: Make sure nothing hangs over the edge of the rack.

3. Close the door.

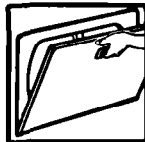

4. Select the Timed Drying cycle (and temperature, if desired), or the Fluff Air cycle (see page 8). Drying time depends on the amount of moisture in the items.

5. Push the Start Button.

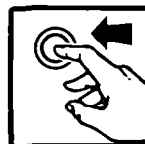

NOTES:

- See the chart below for suggested cycles and settings for the different types of items that might best be rack dried.
- The rack must be removed for normal tumbling.
- Drying time will depend on how much moisture the items hold. The following chart suggests drying times.
- Automatic cycles do not work with the drying rack.

RACK DRY	CYCLE	TEMPERATURE	TIME* (minutes)
Wool sweaters (Block to shape and lay flat on the rack) Stuffed toys or pillows (Cotton or polyester fiber filled)	Timed Drying	LOW or EX LOW	60
Stuffed toys or pillows (Foam rubber filled) Sneakers or canvas shoes	Fluff Air	None; cycle is unheated.	90 30-40

* Reset cycle as needed to complete drying.

Using and maintaining the EASY CLEAN 100™ lint feature

Your dryer has the EASY CLEAN 100™ lint collector basket. This new feature minimizes lint cleaning requirements. It is designed to reduce the need to clean the lint accumulation between each load, up to 100 loads, depending on the types of fabrics being dried. If you dry small loads or delicate fabrics more frequently, lint accumulation may take longer than with large loads or heavy fabrics.

Emptying the lint collector basket

1. When the lint reaches the shaded area within the window, indicating the collector basket is full,

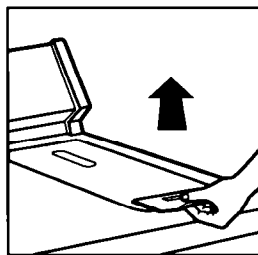
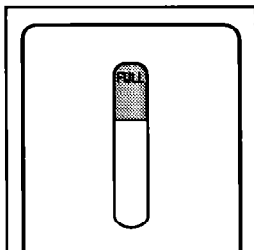

lift the lid until it releases.

2. Hold lid open and pull the basket by its handle until it slides off the tracks.

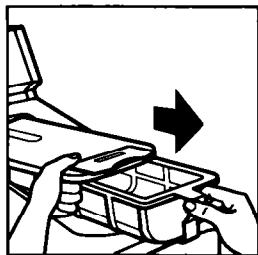

3. Turn basket upside down over a waste can and tap the basket lightly. Lint falls off easiest if basket is full. You may also see sand, grass, or other debris collected in basket.

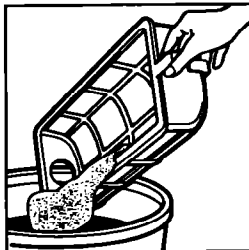

4. Reinsert the basket onto its tracks under the lid, and slide in until it stops.

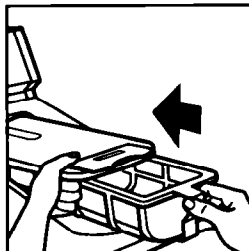

5. Lower lid until magnetic latch clicks.

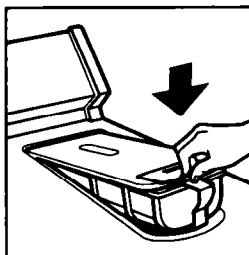

NOTES:

- Do not run the dryer with the lint basket improperly inserted, damaged, blocked, or missing. Doing so can cause overheating and damage to both the dryer and fabrics.
- If there is no lint accumulation in the collector basket after several loads, contact our Consumer Assistance Center at 1-800-253-1301.

Periodic maintenance

You may find it necessary to clean the lint collector basket tray, and the transport tube opening, indicated by arrow.

1. Lift lid all the way and hold open.
2. Suction lint in tray and collector basket tray opening with vacuum cleaner.

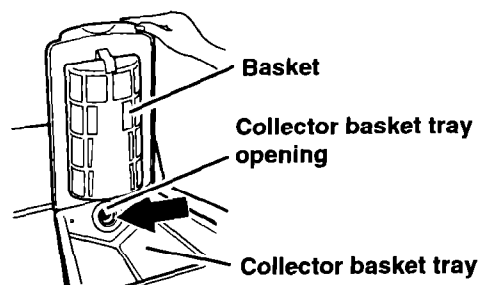

Cleaning the lint collector basket

Laundry detergents and fabric softeners can cause a residue buildup on the lint collector basket. Clean it with a nylon brush if it becomes clogged due to a residue buildup.

Use the following method:

1. Wet both sides of the lint collector basket with hot water.

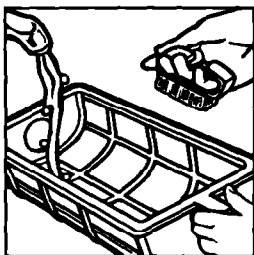

2. Wet a nylon brush with hot water and liquid detergent; brush lint collector basket gently to avoid damage while removing residue buildup.
3. Rinse lint collector basket with hot water.
4. **Thoroughly but gently** dry lint collector basket with a clean towel; replace in dryer.

Caring for Your Dryer

Proper care of your dryer can extend its life. This section explains how to care for your dryer properly and safely.

Cleaning the dryer interior

Garments which contain unstable dyes, such as denim blue jeans or brightly colored cotton items, may discolor the dryer interior. These stains are not harmful to your dryer and will **not** stain future loads of clothes.

To clean dryer drum:

1. Make a paste with powdered detergent and very warm water.
2. Apply paste to a soft cloth and scrub area until all excess dye is removed.



OR

Apply liquid nonflammable household cleaner to the stained area and rub with a cloth until all excess dye is removed.

3. Wipe thoroughly with a damp cloth.
4. Tumble a load of clean cloths, using air cycle, to dry.

⚠ WARNING



Explosion Hazard

Use nonflammable cleaners only.

Failure to do so can result in death, explosion, or fire.

Changing the drum light (on some models)

If your dryer has a drum light, it will be one of two types, shown below and on the next page. The dryer light automatically turns on inside the dryer drum when you open the door.

To change drum light:

1. Unplug the dryer or disconnect the electricity leading to the dryer at the main power supply.
2. Open the dryer door. Remove the light bulb cover from the back wall of the dryer by turning the cover clockwise.

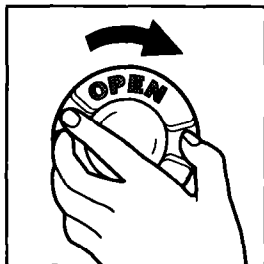

3. Remove the light bulb by turning it counterclockwise.

⚠ WARNING



Fire Hazard

Unplug dryer before changing light bulb.

Replace light bulb cover before operating dryer.

Failure to do so can result in death, fire, or electrical shock.

4. Replace the bulb with a 40-watt appliance bulb only.
5. Replace the light bulb cover and lock in place by turning counterclockwise.



6. Reconnect power supply.

To change drum light:

1. Unplug the dryer or disconnect the electricity leading to the dryer at the main power supply.
2. Open the dryer door. Remove the light bulb cover from the back wall of the dryer by removing the screw located in the lower right corner of the cover.

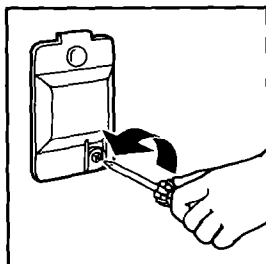

3. Remove the light bulb by turning it counterclockwise.
4. Replace the bulb with a 25-watt appliance bulb only.
5. Replace the light bulb cover.

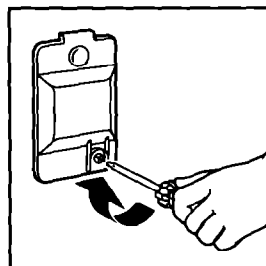

6. Reconnect power supply.

Removing accumulated lint inside the dryer cabinet

Lint can gather inside the dryer cabinet and be a fuel for fire. Lint should be removed every two to three years, or more often, depending on dryer usage. Cleaning should be done by a qualified person. If you have any questions or comments, please call our Consumer Assistance Center at 1-800-253-1301.

!WARNING



Electrical Shock Hazard

Unplug dryer before removing dryer panels.

Wear gloves when handling dryer parts.

Make sure door switch wires are not touching the dryer drum before closing the top. See page 18, Step 7.

Failure to do so can result in death, electrical shock, or serious cuts.

For electric dryers:

1. Unplug the power supply cord or turn off the electrical power.
2. Remove back panel (electric). See the Installation Instructions.
3. Remove lint from shaded area in illustration with a soft brush or vacuum cleaner. Avoid damaging wires or thermostats.
4. Replace panel.
5. Reconnect and level dryer again, if necessary.

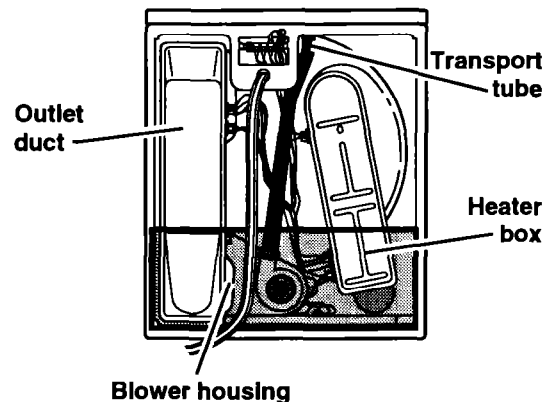

For gas dryers:

1. Unplug the power supply cord or turn off the electrical power.
2. Open top by pulling forward and up at each front corner (see View A). Prop top straight up (at no more than a 90° angle).

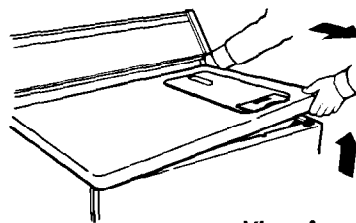

View A

3. Remove two internal screws from front panel flanges (near top front corners). Lift front panel slightly, lifting off lower clip (see lower clip inset of View B). Slowly pull front panel forward, disengaging panel from drum. (Drum will drop slightly.)
4. Move front panel aside and rest edge against side of dryer. Avoid disconnecting wire clip (see wire clip inset of View B) or damaging wires.

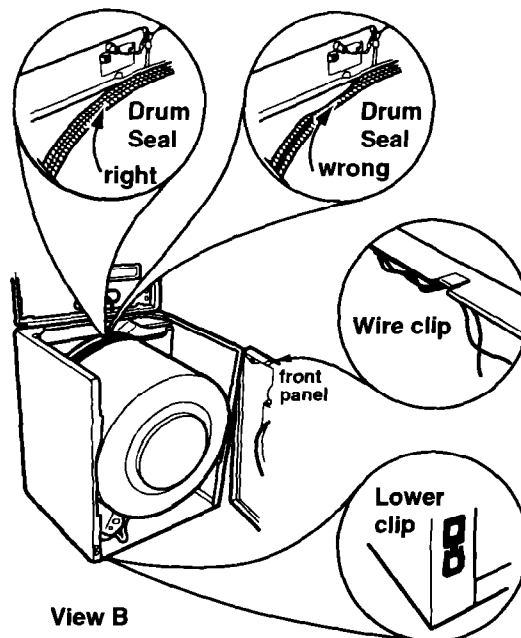

View B

5. Remove lint from shaded area of the illustration with soft brush or vacuum cleaner. Avoid damaging wires, funnel, or ignitor.

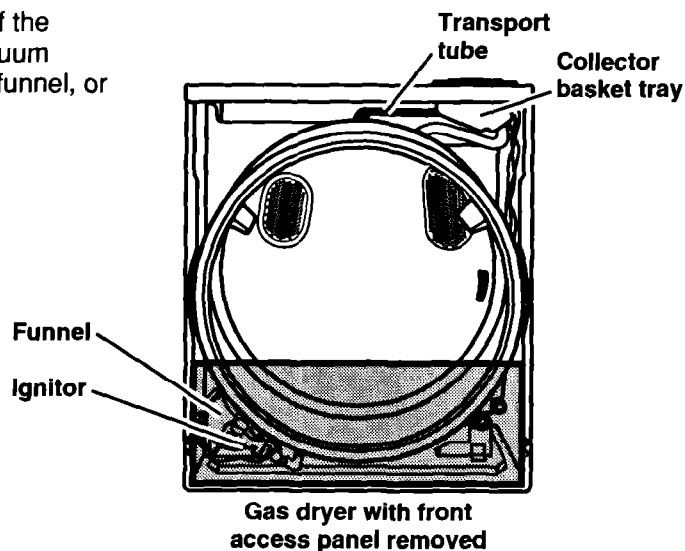

continued on next page

CARING FOR YOUR DRYER

Before reassembling, read these instructions carefully.

6. Make sure transport tube is reinserted into the collector tray as shown. If the tube is not reinserted correctly, it may rub against the dryer drum creating a noise.
7. Reassemble in reverse order. Before closing the top, check the following:
 - Drum seal must be flared out (see drum seal insets of View B) and properly positioned against panel at back of drum. Rotate drum counterclockwise one full turn to check drum seal.
 - Belt should be centered and tight on dryer drum.
 - Wire clip which holds the door switch wires must be anchored in slot in top of front panel (see wire clip inset of View B). Door wires must not touch drum when dryer is operating.
8. Replace top panel. Top and front panels must be securely in place before operating dryer.
9. Reconnect power and level dryer again.

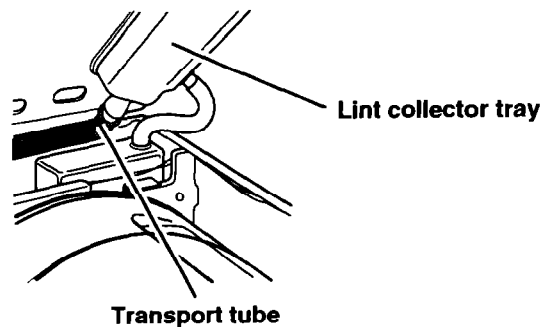

For more information, call our
Consumer Assistance Center.

1-800-253-1301

Laundry Tips

This section provides information on preparing clothes for drying, drying guidelines, and instructions for drying special-care items.

NOTES:

- Refer to your Washer Use and Care Guide for proper washing techniques and additional laundry tips.
- See pages 3 and 4 of this book for Important Safety Information.

Sorting clothes



- Separate dark from light colors; colorfast from non-colorfast. Items properly sorted for washing are usually properly sorted for drying.
- Separate heavy fabrics (denim, towels) from light fabrics (synthetics, permanent press).
- Separate lint givers (towels, chenille) from lint takers (corduroy, synthetics, permanent press). When possible, turn lint takers inside out.

Choosing load sizes



- Mix large items with smaller items. Load the dryer by the amount of space items take up, not by their weight. Do not overload the dryer. Overcrowding causes uneven drying and wrinkling, and can cause items to wear out faster (because of pilling).
- You may need to rearrange large items (sheets, blankets, tablecloths) during a cycle to reduce balling or rolling up.
- For better tumbling action, when drying only a few small items, add one or two lint-free towels. This also prevents small, lightweight items from blocking airflow.

Drying tips



- Close zippers, snaps, and hooks to avoid snagging other items. Remove heat-sensitive trim that can be damaged by drying. Tie strings and sashes so they will not tangle.
- Check garments to make sure all spots and stains were removed during the wash. Do not tumble dry soiled or stained items. Heat may permanently set stains.
- Sharp or metal objects can damage your dryer. Check pockets for pins, clips, money, bolts, nuts, etc. Do not lay these objects on your dryer after emptying pockets. Turn pockets of heavy items inside out for even drying.
- Place small items such as baby socks or hankies in a mesh bag for easier removal.
- Articles to be ironed should be removed from the dryer while still damp.



Using dryer fabric softeners

Dryer fabric softeners are recommended for reducing static cling and for softening fabrics. Always follow package instructions carefully. Use fabric softeners labeled as dryer safe.

- Put one fabric softener sheet on top of the load **before starting the**

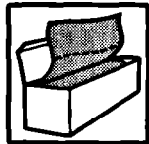

dryer. Do not add a fabric softener sheet **after** the drying cycle has started. Instant heat can cause the fabric softener

to spot fabrics.

- Remove fabric softener stains by wetting the stains and rubbing them with liquid detergent or bar soap and rewash.
- Some fabric softeners may cause a build-up on the lint collector basket. See "Periodic maintenance" on page 13.

Saving energy

- Use the Automatic cycle to dry most loads.
- Dry only full loads without overdrying.
- Avoid overloading dryer, adding wet items to a partly dried load, or opening the door unnecessarily.
- Plan your laundry to dry one load after another. A warm dryer shortens drying time.
- Shorten drying times by exhausting dryer properly and cleaning exhaust duct and outside exhaust hood as needed.
 - Keep vent clean by regularly cleaning your basket when lint indicator window indicates "Full."
 - Use your dryer in a room where room air temperature is above 45°F (7°C).
 - Sort loads by fabric weight and type.

Vacation care

1. Unplug power supply cord or turn off electrical power supply.
2. Clean lint collector basket (see page 13).

Drying special-care items

Most garments and household textiles have manufacturer's care labels with laundering instructions. **Always follow care label directions when they are available.** Pages 9 and 10 include drying instructions for most types of washables. The chart below provides drying instructions for special-care washables.

ITEMS	DRYING INSTRUCTIONS
<p>Blankets and woolens</p> <ul style="list-style-type: none"> • Cotton, rayon, synthetic blankets • Electric blankets, electric sheets, woolen blankets, washable woolen garments 	<p>Machine drying knitted woolens is not recommended. Block to shape when wet and allow to air dry. Line dry blankets in the shade on a breezy day over two lines. Pin edges together and straighten them. When partly dry, turn the blanket over, repin, and restraighten. When dry, brush nap.</p> <p>Dry as recommended for permanent press fabrics on page 9.</p> <p>If manufacturer recommends machine drying:</p> <ol style="list-style-type: none"> 1. Place one or two dry towels in the dryer and preheat 3 to 5 minutes on a high setting. This will dry blankets faster and help avoid pilling. 2. Put blanket in dryer with warm towels. Set control for 20 minutes. 3. Check after 10 minutes. Remove when still damp. Overdrying and long tumbling can cause shrinking and pilling. 4. Place blanket on flat surface, or over two lines to finish drying. Gently stretch to original size and shape. 5. When completely dry, brush gently to raise nap. Press binding with cool iron if needed.
<p>Curtains, slipcovers</p> <ul style="list-style-type: none"> • Draperies, slipcovers 	<p>Remove drapery weights and hooks before laundering. For slipcovers, replace while still slightly damp. They will dry to fit tightly.</p> <p>Dry only a few minutes.</p> <ol style="list-style-type: none"> 1. Leave room in dryer for load to fluff. 2. Remove from dryer while slightly damp. Do not overdry.
<p>Diapers, baby clothes</p>	<p>Wash and dry small items in a mesh bag or pillowcase for convenient handling.</p> <p>Remove diapers and cotton knit items while still slightly damp. They will feel softer, shrink less, and be easier to fold.</p>
<p>Elastic items</p>	<p>Remove from dryer while still slightly damp.</p>
<p>Flame-retardant finishes</p>	<p>Some items have been treated with a flame-retardant finish to improve their resistance to burning. Such items are clearly labeled. To retain flame-retardant qualities through continuous use and washing, clean and dry according to the manufacturer's instructions.</p>

continued on next page

LAUNDRY TIPS

ITEMS	DRYING INSTRUCTIONS
<p>Napped items</p> <ul style="list-style-type: none"> • Corduroy, velveteen 	<p>Dry separately or with similar colors to avoid lint transfer. Follow care label instructions.</p> <ol style="list-style-type: none"> 1. Remove from dryer while there is still a trace of moisture. 2. Smooth, reshape, and air dry before putting away.
<p>Quilted, down-filled items</p>	<p>Follow care label instructions.</p> <ol style="list-style-type: none"> 1. Dry one at a time. 2. Remove from dryer and shake or fluff the item during the drying cycle. 3. Smooth and reshape before putting away.
<p>Snowsuits, jackets</p> <ul style="list-style-type: none"> • Nylon or polyester 	<p>Check label for fiber content, then follow care label instructions.</p> <ol style="list-style-type: none"> 1. Dry garment for about 10 minutes. Remove and turn inside out. Dry for 10 more minutes. 2. Remove from dryer immediately and hang on a non-rusting hanger to finish drying. This will help eliminate wrinkles.
<p>Tinted, dyed, or noncolorfast items</p>	<p>Dry according to fabric, weight, and care label instructions. Wipe the dryer drum carefully to remove any dye or lint that can be transferred to other loads. See "Cleaning the dryer interior" on page 14.</p>
<p>Washable knits</p>	<p>Do not overdry knits. Overdrying can cause shrinking and static cling.</p> <ol style="list-style-type: none"> 1. Select cycle according to fabric and construction. 2. Turn synthetics and blends inside out when drying to avoid pilling. 3. Remove cotton and rayon knits while still slightly damp. Stretch into shape and lay flat to finish drying.

Troubleshooting

Most laundering problems are easily solved if you understand the cause. Check the following list for **laundry** problems you may have and their possible causes. Also refer to the next page for a **dryer** checklist which can help you solve some simple problems without calling for service. If you still need help, see "Requesting Assistance or Service" on page 25.

Common laundry problems

PROBLEM	CAUSE
Greasy spots	<ul style="list-style-type: none">• Dryer fabric softener improperly used. See manufacturer's directions.• Drying soiled items.
Lint on clothes	<ul style="list-style-type: none">• Load not properly sorted.• Overdrying, especially synthetic fabrics that cause lint-attracting static electricity.• Load size too big or heavy.• Tissue or paper left in pockets.• Pilling (surface fuzz caused by normal wear and laundering) attracts lint.
Shrinking	<ul style="list-style-type: none">• Overdrying.• Fabric type and quality inappropriate for drying.• Dryer settings incorrect for fabric type.• Manufacturer's care label instructions not followed.
Slow drying	<ul style="list-style-type: none">• Load too large and bulky to dry quickly.• Dryer located in room with temperature below 45°F (7°C).• Exhaust duct clogged, restricted, or too long.
Stains	<ul style="list-style-type: none">• Drying soiled items.• Dryer fabric softener improperly used. See manufacturer's directions.• Dryer interior stained. (See page 14 for cleaning procedures.)
Static electricity	<ul style="list-style-type: none">• Overdrying.• Dryer fabric softener improperly used. See manufacturer's directions.• Load includes synthetics, synthetic blends, permanent press, and knit fabrics that build up static electricity.
Wrinkling	<ul style="list-style-type: none">• Overloading.• Overdrying, especially permanent press, and synthetic fabrics.• Clothes left in dryer at end of cycle.

TROUBLESHOOTING

Common dryer problems

1. Dryer will not start.

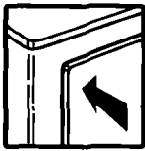

Is the dryer door firmly closed?

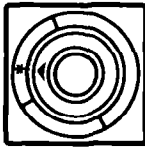

Are the controls set in a ON position?



Did you firmly push the Start Button?

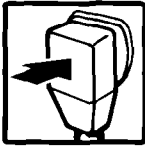

Is the power cord plugged in?

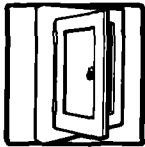

Have you blown a fuse or tripped the circuit breaker?



2. Lint accumulation in hood or exhaust duct, or extended drying times.

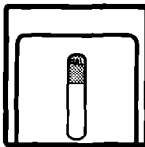

Is lint collector basket full?

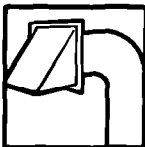

Is exhaust duct or outside exhaust hood clogged with lint?

NOTE: Your new dryer may blow out accumulated lint from the existing exhaust system.



3. No heat

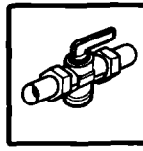

For gas dryers, are the valves open on the dryer and the supply line?

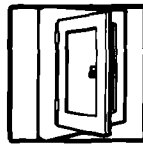

For electric dryers, have you blown a fuse or tripped a circuit breaker? Also check if a time-delayed fuse or circuit breaker has been used.



4. Noises



If the dryer hasn't been used for awhile, there may be a thumping sound from the support rollers.

You may hear an airflow noise that is different than your old dryer. This noise is common.

Has transport tube been reinserted correctly after cabinet cleaning? See page 18.

If you still have problems, see "Requesting Assistance or Service" on page 25.

Requesting Assistance or Service

Before calling for assistance or service, please check "Troubleshooting" on pages 23-24. It may save you the cost of a service call. If you still need help, follow the instructions below.

1. If you need assistance* ...

Call the Whirlpool Consumer Assistance



Center telephone number. Dial toll-free from anywhere in the U.S.A.:

1-800-253-1301

and talk with one of our trained consultants. The consultant can instruct you in how to obtain satisfactory operation from your appliance or, if service is necessary, recommend a qualified service company in your area.

If you prefer, write to:

Whirlpool Brand Home Appliances
Consumer Assistance Center
c/o Correspondence Dept.
414 N. Peters Rd.
Knoxville, TN 37922

Please include a daytime phone number in your correspondence.

2. If you need service* ...

Whirlpool has a nationwide network of



authorized Whirlpool service companies. Whirlpool service technicians are trained to fulfill the product warranty and provide after-warranty service,

anywhere in the United States. To locate the authorized Whirlpool service company in your area, call our Consumer Assistance Center telephone number (see Step 1) or look in your telephone directory Yellow Pages under:

**• APPLIANCE-HOUSEHOLD-
MAJOR, SERVICE & REPAIR**

- See: Whirlpool Appliances or
Authorized Whirlpool Service
(Example: XYZ Service Co.)

**• WASHING MACHINES &
DRYERS, SERVICE & REPAIR**

- See: Whirlpool Appliances or
Authorized Whirlpool Service
(Example: XYZ Service Co.)

3. If you need FSP® replacement parts ...

FSP is a registered trademark of Whirlpool Corporation for quality parts. Look for this symbol of quality whenever you need a replacement part for your WHIRLPOOL® appliance. FSP replacement parts will fit right and work right, because they are made to the same exacting specifications used to build every new WHIRLPOOL appliance.

To locate FSP replacement parts in your area, refer to Step 2 or call the Whirlpool Consumer Assistance Center number in Step 1.

4. If you are not satisfied with how the problem was solved ...

- Contact the Major Appliance Consumer Action Program (MACAP). MACAP is a group of independent consumer experts that voices consumer views at the highest levels of the major appliance industry.
- Contact MACAP only when the dealer, authorized servicer, and Whirlpool have failed to resolve your problem.

Major Appliance Consumer Action Program
20 North Wacker Drive
Chicago, IL 60606

- MACAP will in turn inform us of your action.

* When asking for help or service:

Please provide a detailed description of the problem, your appliance's complete model and serial numbers, and the purchase date. (See page 2.) This information will help us respond properly to your request.

NOTES

NOTES

WHIRLPOOL® Dryer Warranty

LENGTH OF WARRANTY	WHIRLPOOL WILL PAY FOR																						
FULL ONE-YEAR WARRANTY From Date of Purchase	FSP® replacement parts and repair labor to correct defects in materials or workmanship. Service must be provided by an authorized Whirlpool service company.																						
SECOND THROUGH FIFTH-YEAR LIMITED WARRANTY On EASY CLEAN 100™ lint feature parts only From Date of Purchase	FSP replacement parts to correct defects in materials or workmanship of the following parts: <table border="0"> <thead> <tr> <th>Part</th> <th>Part No.</th> </tr> </thead> <tbody> <tr> <td>Collector assembly</td> <td>3404418 (white), 3404419 (almond)</td> </tr> <tr> <td>Hinge</td> <td>3402247</td> </tr> <tr> <td>Seal - lid</td> <td>3402261</td> </tr> <tr> <td>Seal - basket</td> <td>3402260</td> </tr> <tr> <td>Seal - transport tube, lower</td> <td>3401804</td> </tr> <tr> <td>Seal - transport tube, upper</td> <td>3402270</td> </tr> <tr> <td>Transport tube assembly</td> <td>3399995</td> </tr> <tr> <td>Recirculate tube</td> <td>3399992</td> </tr> <tr> <td>Tray assembly</td> <td>3402306</td> </tr> <tr> <td>Latch assembly</td> <td>3404451 (white), 3404452 (almond)</td> </tr> </tbody> </table>	Part	Part No.	Collector assembly	3404418 (white), 3404419 (almond)	Hinge	3402247	Seal - lid	3402261	Seal - basket	3402260	Seal - transport tube, lower	3401804	Seal - transport tube, upper	3402270	Transport tube assembly	3399995	Recirculate tube	3399992	Tray assembly	3402306	Latch assembly	3404451 (white), 3404452 (almond)
Part	Part No.																						
Collector assembly	3404418 (white), 3404419 (almond)																						
Hinge	3402247																						
Seal - lid	3402261																						
Seal - basket	3402260																						
Seal - transport tube, lower	3401804																						
Seal - transport tube, upper	3402270																						
Transport tube assembly	3399995																						
Recirculate tube	3399992																						
Tray assembly	3402306																						
Latch assembly	3404451 (white), 3404452 (almond)																						
WHIRLPOOL WILL NOT PAY FOR																							
<p>A. Service calls to:</p> <ol style="list-style-type: none"> 1. Correct the installation of your dryer. 2. Instruct you how to use your dryer. 3. Replace house fuses or correct house wiring or plumbing. 4. Replace light bulbs. <p>B. Repairs when your dryer is used in other than normal, single-family household use.</p> <p>C. Pickup and delivery. Your dryer is designed to be repaired in the home.</p> <p>D. Damage to your dryer caused by accident, misuse, fire, flood, acts of God, or use of products not approved by Whirlpool.</p> <p>E. Any labor costs during the limited warranty.</p> <p>F. Repairs to parts or systems caused by unauthorized modifications made to the appliance.</p>																							

8-95

WHIRLPOOL CORPORATION SHALL NOT BE LIABLE FOR INCIDENTAL OR CONSEQUENTIAL DAMAGES. Some states do not allow the exclusion or limitation of incidental or consequential damages, so this exclusion or limitation may not apply to you. This warranty gives you specific legal rights, and you may also have other rights which vary from state to state.

Outside the United States, a different warranty may apply. For details, please contact your authorized Whirlpool dealer.

If you need service, first see the "Troubleshooting" section of this book. After checking "Troubleshooting," additional help can be found by checking the "Requesting Assistance or Service" section, or by calling our Consumer Assistance Center telephone number, **1-800-253-1301**, from anywhere in the U.S.A.